



L3HARRIS



**NARDA
Safety
Test
Solutions**
S.r.l. Socio Unico

<http://www.narda-sts.it>

Sales & Support:
Via Rimini, 22
20142 - Milano (MI)
Tel.: +39 02 581881
Fax: +39 02 58188273

Manufacturing Plant:
Via Benessea, 29/B
17035 - Cisano sul Neva (SV)
Tel.: +39 0182 58641
Fax: +39 0182 586400



User's Manual

PMM 9010

**EMI CISPR RECEIVER
10 Hz ÷ 30 MHz**

Including description of:

- **PMM 9010F Fast EMI CISPR Receiver**
10 Hz ÷ 30 MHz Full compliance
- **PMM 9010/03P EMI CISPR Receiver**
10 Hz ÷ 30 MHz Full compliance
30 MHz ÷ 300 MHz Compliance (PRF ≥ 10Hz)
- **PMM 9010/30P EMI CISPR Receiver**
10 Hz ÷ 30 MHz Full compliance
30 MHz ÷ 3 GHz Pre compliance
- **PMM 9010/60P EMI CISPR Receiver**
10 Hz ÷ 30 MHz Full compliance
30 MHz ÷ 6 GHz Pre compliance
- **PMM 9030 EMI CISPR Receiver**
Full compliance *extension (up to 3 GHz)*
- **PMM 9060 EMI CISPR Receiver**
Full compliance *extension (up to 6 GHz)*
- **PMM 9180 EMI CISPR Receiver**
Full compliance *extension (up to 18 GHz)*
- **PMM 9010/Click Analyzer option**

SERIAL NUMBER OF THE INSTRUMENT

You can find the Serial Number on the rear panel of the instrument.

Serial Number is in the form: 0000X00000.

The first four digits and the letter are the Serial Number prefix, the last five digits are the Serial Number suffix. The prefix is the same for identical instruments, it changes only when a configuration change is made to the instrument.

The suffix is different for each instrument.

Document 9010EN-10440-2.64 - Copyright © NARDA 2021

NOTE:

® Names and Logo are registered trademarks of Narda Safety Test Solutions GmbH and L3 Communications Holdings, Inc. – Trade names are trademarks of the owners.

 If the instrument is used in any other way than as described in this User’s Manual, it may become unsafe.

Before using this product, the related documentation must be read with great care and fully understood to familiarize with all the safety prescriptions.

To ensure the correct use and the maximum safety level, the User shall know all the instructions and recommendations contained in this document.

 This product is a **Safety Class I** instrument according to IEC classification and has been designed to meet the requirements of EN61010-1 (Safety Requirements for Electrical Equipment for Measurement, Control and Laboratory Use).







In accordance with the IEC classification, the power supply of this product meets requirements **Safety Class II** and **Installation Category II** (having double insulation and able to carry out mono-phase power supply operations).

It complies with the requirements of **Pollution Class II** (usually only non-conductive pollution). However, occasionally it may become temporarily conductive due to condense on it.

The information contained in this document is subject to change without notice.

EXPLANATION OF ELECTRICAL AND SAFETY SYMBOLS :

 You now own a high-quality instrument that will give you many years of reliable service. Nevertheless, even this product will eventually become obsolete. When that time comes, please remember that electronic equipment must be disposed of in accordance with local regulations. This product conforms to the WEEE Directive of the European Union (2002/96/EC) and belongs to Category 9 (Monitoring and Control Instruments). You can return the instrument to us free of charge for proper environment friendly disposal. You can obtain further information from your local Narda Sales Partner or by visiting our website at www.narda-sts.it.

	Warning, danger of electric shock		Earth
	Read carefully the Operating Manual and its instructions, pay attention to the safety symbols.		Unit Earth Connection
	Earth Protection		Equipotential

EXPLANATION OF SYMBOLS USED IN THIS DOCUMENT :

 The **DANGER** sign draws attention to a serious risk to a person’s safety, which, if not avoided, will result in death or serious injury. All the precautions must be fully understood and applied before proceeding.

 The **WARNING** sign indicates a hazardous situation, which, if not avoided, could result in death or serious injury. All the precautions must be fully understood and applied before proceeding.

 The **CAUTION** sign indicates a hazardous situation, which, if not avoided, could result in minor or moderate injury.

 The **NOTICE** sign draws attention to a potential risk of damage to the apparatus or loss of data.

 The **NOTE** sign draws attention to important information.

Contents

Explanation of electrical and safety symbols.....	Page II
General safety considerations and instructions.....	XIII
PMM 9010 EC Declaration of Conformity	XVIII
PMM 9010F EC Declaration of Conformity	XV
PMM 9010/03P EC Declaration of Conformity	XVI
PMM 9010/30P EC Declaration of Conformity	XVII
PMM 9010/60P EC Declaration of Conformity	XVIII
PMM 9030 EC Declaration of Conformity	XIX
PMM 9060 EC Declaration of Conformity	XX
PMM 9180 EC Declaration of Conformity	XXI
PMM 9010/Click EC Declaration of Conformity	XXII
PMM 9010/Click4E EC Declaration of Conformity	XXIII
1. General Information	Page
1.1 Documentation.....	1-1
1.2 Operating Manual changes.....	1-1
1.3 Introduction to PMM 9010.....	1-1
1.4 Instrument Items.....	1-2
1.5 Optional accessories.....	1-2
1.6 Other accessories.....	1-2
1.7 Main Specifications.....	1-3
1.8 Front Panel.....	1-5
1.9 Rear Panel.....	1-6
1.10 Functional Description.....	1-7
1.11 Ultra fast measurement: a unique feature of the PMM 9010.....	1-7
1.12 Emission measurement.....	1-8
2 Installation	Page
2.1 Introduction.....	2-1
2.2 Initial Inspection.....	2-1
2.3 Packing and Unpacking.....	2-1
2.4 Preparation for Use.....	2-1
2.5 Battery Charger.....	2-1
2.5.1 To substitute the mains connector.....	2-1
2.5.2 To Check the internal batteries.....	2-1
2.5.3 Indication of the battery on the screen and with PW led.....	2-2
2.6 Environment.....	2-2
2.7 Return for Service.....	2-3
2.8 Equipment Cleaning.....	2-3
2.9 Equipment ventilation.....	2-3
2.10 Hardware Installation.....	2-3
2.11 Using an Artificial Mains Network (AMN or LISN).....	2-4
2.12 Using Pulse Limiter.....	2-4
2.13 Using Current and Voltage Probes.....	2-5
2.14 Using Antennas and other Transducers.....	2-5
2.15 The User Port.....	2-5
2.16 PMM L2-16A remote cable Configuration for PMM 9010.....	2-6
2.17 PMM LISN three phase remote cable Configuration for 9010.....	2-7
2.18 PMM L2-16 remote cable Configuration for PMM 9010.....	2-8
2.19 PMM L3-25 remote cable Configuration for PMM 9010.....	2-9
3 Setup and Panel Instructions	Page
3.1 Introduction.....	3-1
3.2 Display.....	3-1
3.3 Autocal.....	3-2
3.4 Unit.....	3-3
3.5 RF OUT.....	3-3
3.6 Panel.....	3-3
3.7 RS 232 (Speed).....	3-4

4 Sweep Mode operating instructions	Page
4.1 Introduction.....	4-1
4.2 Measure.....	4-2
4.2.1 Frequency.....	4-2
4.2.2 Level.....	4-3
4.2.2.1 Input: Attenuator and Preamplifier.....	4-3
4.2.2.2 Misc.....	4-4
4.2.2.2.1 Tracking generator.....	4-4
4.2.2.3 Detector.....	4-5
4.2.2.4 Smart detector.....	4-5
4.2.3 Conversion factor.....	4-6
4.3 Limit.....	4-6
4.4 Display.....	4-6
4.5 Marker.....	4-7
4.6 Load & Store.....	4-8
4.7 Ultra fast FFT scan.....	4-8
5 Analyzer Mode operating instructions	Page
5.1 Introduction.....	5-1
5.2 Frequency.....	5-2
5.3 RBW.....	5-3
5.4 Level.....	5-3
5.4.1 Input Attenuators and Preamplifier.....	5-3
5.4.2 OVER RANGE Message.....	5-4
5.4.3 Misc.....	5-4
5.4.3.1 Tracking generator.....	5-5
5.4.4 Detector.....	5-5
5.4.5 Conversion factor.....	5-6
5.5 Marker.....	5-6
5.6 Esc.....	5-6
6 Manual Mode operating instructions	Page
6.1 Introduction.....	6-1
6.2 Frequency.....	6-2
6.3 Level.....	6-2
6.3.1 Input: Attenuator and preamplifier.....	6-3
6.3.2 Misc.....	6-3
6.4 RBW.....	6-5
6.5 Hold Time.....	6-5
6.6 Demodulator.....	6-5
7. Applications	Page
7.1 Measuring the EMI Voltage.....	7-1
7.1.1 Measuring Principle with a LISN.....	7-1
7.1.2 Coupling Networks.....	7-1
7.1.2.1 AMN.....	7-2
7.1.2.2 Current probe.....	7-3
7.1.2.3 Voltage probe.....	7-3
7.1.3 Test setup.....	7-4
7.1.4 Guidance on a preliminary Measuring Procedure.....	7-4
7.1.5 Remarks and hints for Measuring.....	7-5
8. Updating firmware and Activation code Utility	Page
8.1 Introduction.....	8-1
8.2 System requirements	8-1
8.3 Preparing the Hardware.....	8-1
8.4 Software installation.....	8-1
8.5 To transfer data.....	8-3
8.6 9010 Set code utility	8-5

9. PMM 9010/03P EMI CISPR Receiver
10 Hz ÷ 30 MHz Full compliance
> 30 MHz Compliance (PRF ≥ 10Hz)

PMM 9010/30P EMI CISPR Receiver
10 Hz ÷ 30 MHz Full compliance
30 MHz ÷ 3 GHz Pre compliance

PMM 9010/60P EMI CISPR Receiver
10 Hz ÷ 30 MHz Full compliance
30 MHz ÷ 6 GHz Pre compliance

General Information

9.1 Documentation.....	9-2
9.2 Operating Manual changes.....	9-2
9.3 Introduction to PMM 9010/03P/30P/60P.....	9-3
9.4 Instrument Items.....	9-4
9.5 Optional accessories.....	9-4
9.6 Other accessories.....	9-4
9.7 PMM 9010/03P Main Specifications.....	9-5
9.8 PMM 9010/03P Front Panel.....	9-6
9.9 PMM 9010/03P Rear Panel.....	9-7
9.10 PMM 9010/30P Main Specifications.....	9-8
9.11 PMM 9010/30P Front Panel.....	9-9
9.12 PMM 9010/30P Rear Panel.....	9-10
9.13 PMM 9010/60P Main Specifications.....	9-11
9.14 PMM 9010/60P Front Panel.....	9-12
9.15 PMM 9010/60P Rear Panel.....	9-13

10 Click Mode Operating Instructions (Option)

	Page
10.1 Introduction.....	10-1
10.2 Click Mode Activation procedure.....	10-1
10.3 Enter the Click Mode.....	10-4
10.4 Introduction to the discontinuous disturbance (click) measurement.....	10-5
10.4.1 Determination of click rate.....	10-6
10.4.2 Preliminary Conformity and Exceptions.....	10-6
10.4.2.1 Old and New exceptions.....	10-6
10.4.3 Calculate Limit Quartile.....	10-7
10.4.4 Measurements vs Lq limit.....	10-7
10.5 Start.....	10-7
10.5.1 Stop and pause.....	10-9
10.6 Report.....	10-9
10.6.1 Fail during determination of the click rate N.....	10-9
10.6.2 Report after a successful test with less than 5 instantaneous switching at one frequency.....	10-9
10.6.3 Report after a successful test at 4 frequencies.....	10-10
10.6.4 Report after a line search.....	10-10
10.7 Setup.....	10-11
10.7.1 External attenuator.....	10-11
10.7.2 Limit.....	10-12
10.7.3 Determination of N.....	10-13
10.7.4 Factor f.....	10-13
10.7.5 Stop on Fail.....	10-13
10.7.6 Terminate on.....	10-14
10.7.7 Line.....	10-14
10.7.8 Max time.....	10-16
10.7.9 Idle Frequency.....	10-16
10.7.10 Idle Level.....	10-16
10.7.11 Smart Measure.....	10-16
10.8 Click option.....	10-17
10.8.1 Optional PMM 9010 Click4E Four Channels Click meter	10-17
10.9 Test setup.....	10-18
10.10 Diagnostic.....	10-18
10.11 Click reports with PMM Emission Suite	10-19

11 PMM 9030/9060/9180 EMI CISPR Receiver extension 30 MHz – 3GHz / 6GHz / 18GHz (Option)	Page
11.1 Introduction to PMM 9030/9060/9180.....	11-1
11.2 Instruments items.....	11-2
11.3 Optional PMM accessories.....	11-2
11.4 Other accessories.....	11-2
11.5 PMM 9030 Main specifications.....	11-3
11.6 PMM 9030 Front and rear panel.....	11-5
11.7 PMM 9060 Main specifications.....	11-6
11.8 PMM 9060 Front and rear panel.....	11-8
11.9 PMM 9180 Main specifications.....	11-9
11.10 PMM 9180 Front and rear panel.....	11-11
11.11 Functional description.....	11-12
11.12 No coaxial cable between the antenna and the receiver.....	11-12
11.13 Emission measurements.....	11-13
11.14 Installation.....	11-14
11.14.1 Introduction.....	11-14
11.14.2 Initial inspection.....	11-14
11.14.2.1 Packing and Unpacking.....	11-14
11.14.3 Preparation for use.....	11-14
11.14.4 Battery charger.....	11-14
11.14.4.1 To replace the mains connector of the battery charger.....	11-14
11.14.4.2 To charge the internal battery.....	11-14
11.14.4.3 To Supply 9030/9060/9180 through the mains power socket by SPA-01.....	11-14
11.14.4.4 Indication of the battery status on the screen and with PW led...	11-15
11.14.5 Environment.....	11-16
11.14.6 Return for Service.....	11-16
11.14.7 Equipment cleaning.....	11-16
11.14.8 Equipment ventilation.....	11-16
11.14.9 Hardware installation.....	11-17
11.14.10 PMM 9010+ PMM 9030/9060/9180 initial screen.....	11-18
11.14.11 Led on the PMM 9010 and on the PMM 9030/9060/9180.....	11-18
11.14.12 PMM 9010 + PMM 9030/9060/9180 main screen.....	11-18
11.14.13 PMM 9010 + PMM 9030/9060/9180 Setup panel.....	11-19
11.14.14 PMM 9010 + PMM 9030/9060/9180 Link failure.....	11-20
11.14.15 Antenna Mounting Kit AMK-01 and AMK-02.....	11-21
Antenna Mounting Kit AMK-01 with BL-01, LP-02, LP-04, AS-02, AS-03, AS-04, AS-05 and AS-06.....	11-21
Antenna Mounting Kit AMK-01 with LP-03.....	11-25
Antenna Mounting Kit AMK-02 with BL-01, AS-07 and AS-08,,.....	11-27
11.15 Analyzer Mode operating instructions.....	11-37
11.15.1 Introduction.....	11-37
11.15.2 Frequency.....	11-38
11.15.3 RBW.....	11-38
11.15.4 Level.....	11-39
11.15.4.1 Input: Attenuators and preamplifier.....	11-39
11.15.4.2 Misc.....	11-40
11.15.4.3 Detector.....	11-40
11.15.4.4 Conversion factor.....	11-41
11.15.5 Marker.....	11-41
11.15.6 ESC.....	11-41

11.16 Sweep Mode operating instructions.....	11-42
11.16.1 Introduction.....	11-42
11.16.2 Measure.....	11-43
11.16.2.1 Frequency.....	11-43
11.16.2.2 Advanced.....	11-44
11.16.2.3 Level.....	11-44
11.16.2.3.1 Input: Attenuators and preamplifier.....	11-45
11.16.2.3.2 Misc.....	11-45
11.16.2.3.3 Tracking generator.....	11-45
11.16.2.3.4 Detector.....	11-46
11.16.2.4 Conversion factor.....	11-46
11.16.3 Limit.....	11-46
11.16.4 Display.....	11-47
11.16.5 Marker.....	11-47
11.16.6 Load store.....	11-48
11.17 Manual Mode operating instructions.....	11-49
11.17.1 Introduction.....	11-49
11.17.2 Frequency.....	11-50
11.17.3 Level.....	11-50
11.17.3.1 Input: Attenuator and preamplifier.....	11-51
11.17.3.2 Misc.....	11-52
11.17.4 RBW.....	11-52
11.17.5 Hold me.....	11-53
11.17.6 Demodulator.....	11-53
11.18 Updating firmware.....	11-54
11.18.1 Introduction.....	11-54
11.18.2 System requirements.....	11-54
11.18.3 Preparing the Hardware.....	11-54
11.18.4 Software installation.....	11-54
11.18.5 To transfer data.....	11-56
12 PMM 9010-RMA Rack Mount Adapter for Rack 19”	
12.1 Introduction.....	12-1
12.2 Instruments Items.....	12-1
12.3 Optional accessories.....	12-1
12.4 PMM 9010-RMA Main Specifications.....	12-2
12.5 PMM 9010-RMA Front view.....	12-2
12.6 PMM 9010-RMA Inside view.....	12-3
12.7 Rack requirements.....	12-4
12.8 Required equipment.....	12-4
12.9 Moving chassis.....	12-4
12.10 Installation guidelines.....	12-5
12.11 Installing the PMM 9010-RMA.....	12-6
12.12 Use of the PMM 9010-RMA with PMM 9010.....	12-7

13 APD Mode Operating Instructions (Amplitude Probability Distribution)	
13.1 Introduction.....	13-1
13.2 Pre-conditions and Settings.....	13-2
13.2.1 Entering the function	13-3
13.2.2 Methods	13-3
13.3 Setup.....	13-4
13.3.1 Limit 1 E	13-4
13.3.2 Limit 1 P	13-4
13.3.3 Limit 2 E	13-4
13.3.4 Limit 2 P	13-5
13.3.5 YY Offset	13-5
13.3.6 Start Frequency	13-5
13.3.7 Stop Frequency.....	13-5
13.3.8 Num. of freqs	13-5
13.3.9 Time	13-6
13.3.10 Method	13-6
13.3.11 Search Hold Time	13-6
13.3.12 Conversion Factor	13-6
13.3.13 Preselector	13-6
13.3.14 Min. Attenuation.....	13-7
13.3.15 PreAmplifier	13-7
13.4 Operation	13-8
13.4.1 Manual (APD).....	13-8
13.4.1.1 Frequency	13-9
13.4.1.2 Input	13-10
13.4.1.3 Clear	13-11
13.4.1.4 Setup	13-11
13.4.2 Report (APD)	13-12
13.4.2.1 MHz	13-12
13.4.2.2 Pk dB μ V	13-12
13.4.2.3 Δ L Peak	13-12
13.4.2.4 Δ L1	13-12
13.4.2.5 E	13-12
13.4.2.6 Δ L2	13-12
13.4.2.7	13-12
13.4.2.8 Time	13-12
13.4.2.9 P/F	13-12
13.4.3 Start (APD)	13-13
13.4.3.1 Sweep running	13-13
13.4.3.2 Signal by signal measurements	13-13
13.4.3.3 Finish and Next Step	13-14
13.4.3.4 Report	13-14
13.4.4 Default	13-14
13.5 Internal Generator	13-15
13.6 Panel Save and Recall	13-15

	Page
14 Remote control	
14.1 Introduction	14-1
14.2 Communication	14-1
14.2.1 RS 232 (Speed)	14-1
14.3 Protocol	14-1
14.4 Format	14-1
14.5 PMM 9010 COMMANDS	14-2
14.6 List of commands.....	14-3
14.6.1 QUERY Commands	14-5
14.6.2 SETTING Commands	14-11
14.6.3 Analyzer Reply	14-26
14.6.3.1 Reply example	14-26
14.6.4 Sweep Structure	14-28
14.6.5 Procedure to read a measure stored by the PMM 9010	14-31
14.7 Special notes for 9010 Fast.....	14-31
14.7.1 Analyzer Max-Hold function.....	14-33
14.7.1.1 Analyzer Max-Hold Activation.....	14-33
14.7.1.2 Analyzer Max-Hold Reset.....	14-33
14.7.1.3 Analyzer Max-Hold Pause (suspend).....	14-33
14.7.1.4 Analyzer MAX-HOLD related COMMANDS.....	14-34
14.8 Sweep Mode commands sequence example.....	14-35
15 9010F Fast	
15.1 Introduction to 9010F.....	15-1
15.1.1 Principle of operation.....	15-2
15.1.2 Instrument Items.....	15-3
15.1.3 Optional accessories.....	15-3
15.1.4 Other accessories.....	15-3
15.1.5 Main specification.....	15-4
15.1.6 Functional description.....	15-8
15.1.7 Ultra fast measurement: an unique feature of the PMM 9010F.....	15-8
15.2 Sweep Mode.....	15-9
15.2.1 Ultra Fast FFT scan.....	15-9
15.2.2 Measure.....	15-10
15.2.2.1 Frequency.....	15-10
15.2.2.2 Level.....	15-11
15.2.2.3 Input: Attenuators and preamplifier.....	15-11
15.2.2.4 Misc.....	15-12
15.2.2.5 RF Output Generator.....	15-12
15.2.2.6 Detector.....	15-13
15.2.2.7 Conversion factor.....	15-13
15.2.3 Limit.....	15-14
15.2.4 Display.....	15-14
15.2.5 Market.....	15-15
15.2.6 Load Store.....	15-16
15.3 Analyzer Mode.....	15-17
15.3.1 Frequency.....	15-18
15.3.2 RBW.....	15-19
15.3.3 Level.....	15-19
15.3.3.1 Input: Attenuators and preamplifier.....	15-19
15.3.3.2 OVER RANGE Message.....	15-20
15.3.3.3 MISC.....	15-20
15.3.3.4 Tracking generator.....	15-21
15.3.3.5 Detector.....	15-21
15.3.3.6 Conversion factor.....	15-22
15.3.4 Marker.....	15-22
Annex - A RMS-AVG and C-AVG Detectors	
A-A.1 Introduction.....	A-A-1
A-A.2 RMS-AVG Definition.....	A-A-1
A-A.3 RMS-AVG Activation Procedure (option).....	A-A-1
A-A.4 C-AVG Definition.....	A-A-3
A-A.5 Sweep Mode.....	A-A-4
A-A.5.1 Detector selection.....	A-A-4
A-A.5.2 Smart Detector.....	A-A-5
A-A.6 Operating Manual Changes.....	A-A-6



Annex - B Additional RBW filters	Page
A-B.1 Introduction.....	A-B-1
A-B.2 MIL-STD-461E Activation procedure (option).....	A-B-1
A-B.3 Analyzer Mode.....	A-B-2
A-B.3.1 RBW Selection.....	A-B-2
A-B.3.2 MIL Filters.....	A-B-2
A-B.3.3 MIL Filters over 30MHz.....	A-B-3
A-B.4 Manual Mode.....	A-B-3
A-B.4.1 RBW Selection.....	A-B-3
A-B.4.2 MIL Filters.....	A-B-3
A-B.4.3 Hold Time.....	A-B-4
A-B.5 Operating Manual Changes.....	A-B-4
Annex - C Click4E Four Channels Click Meter Option	
A-C.1 Introduction.....	A-C-1
A-C.2 Installation.....	A-C-2
A-C.2.1 Initial Inspection.....	A-C-2
A-C.2.2 Packing and Unpacking.....	A-C-2
A-C.2.3 Preparation for Use.....	A-C-2
A-C.2.4 Click4E Option mains supply.....	A-C-2
A-C.2.5 PMM 9010 Battery charging.....	A-C-3
A-C.2.6 Indication of the battery status on the screen and with PW led.....	A-C-4
A-C.2.7 Environment.....	A-C-4
A-C.2.8 Return for Service.....	A-C-5
A-C.2.9 Equipment Cleaning.....	A-C-5
A-C.2.10 Equipment ventilation.....	A-C-5
A-C.2.11 Hardware Installation.....	A-C-5
A-C.3 Click Mode.....	A-C-6
A-C.3.1 Using an Artificial Mains Network (AMN or LISN)	A-C-6
A-C.3.2 Using the Pulse Limiter.....	A-C-6
A-C.3.3 Click Mode menu.....	A-C-7
A-C.4 Self Calibration.....	A-C-7
A-C.5 Operation.....	A-C-8
A-C.5.1 Smart Measure.....	A-C-8
A-C.6 Operating Manual Changes.....	A-C-8
Annex - D Measure the insertion loss of a Line Impedance Stabilization Network (LISN) with a PMM 9010 Receiver	
A-D.1 Introduction.....	A-D-1
A-D.2 Operation.....	A-D-1
A-D.3 Test setup.....	A-D-1
A-D.4 Settings.....	A-D-1
A-D.5 Measure the Insertion Loss (Voltage Division Factor).....	A-D-2
A-D.6 Connecting the LISN under test.....	A-D-2
A-D.7 Starting the Sweep.....	A-D-3
A-D.8 Marker.....	A-D-4
A-D.9 LISNs with PMM Emission Suite.....	A-D-4
A-D-10 Note.....	A-D-5
A-D-11 PMM LISNs and Passive probes.....	A-D-6
A-D-12 Conversion table dBµV <> µV <> dBm.....	A-D-7
A-D-13 LISN Service kit.....	A-D-8

Figures

Figure		Page
1-1	Front Panel 9010.....	1-5
1-2	Rear Panel 9010.....	1-6
1-3	BP-02 Replaceable battery.....	1-6
1-4	PMM 9010 Functional Diagram.....	1-7
2-1	PMM 9010 initial screen showing the results of the initial self-test and the five main function keys menu.....	2-4
2-2	PMM L2-16A remote cable configuration for 9010.....	2-6
2-3	PMM LISN three phase remote cable configuration for 9010.....	2-7
2-4	PMM L2-16 remote cable configuration for PMM 9010.....	2-8
2-5	PMM L3-25 remote cable configuration for PMM 9010.....	2-9
3-1	Display setting.....	3-1
4-1	Sweep.....	4-1
5-1	Spectrum.....	5-1
6-1	Manual.....	6-1
7-1	AMN Principle: a) Δ -type or T-type LISN ; b) V-type LISN.....	7-2
7-2	Example of test Setup for RFI Voltage Measurements.....	7-3
9-1	9010/03P Front Panel	9-6
9-2	9010/03P Rear Panel	9-7
9-3	BP-02 Replaceable battery for 9010/03P	9-7
9-4	9010/30P Front Panel	9-9
9-5	9010/30P Rear Panel	9-10
9-6	BP-02 Replaceable battery for 9010/30P	9-10
9-7	9010/60P Front Panel	9-12
9-8	9010/60P Rear Panel	9-13
9-9	BP-02 Replaceable battery for 9010/60P	9-13
10-1	Click.....	10-1
11-1	PMM 9030 Front and rear panels.....	11-5
11-2	PMM 9060 Front and rear panels.....	11-8
11-3	PMM 9180 Front and rear panels.....	11-11
11-4	PMM 9030/9060/9180 Functional BLOCK Diagram.....	11-12
11-5	PMM 9030/9060/9180 Fiber Optic Link to PMM 9010.....	11-17
11-6	AMK-01 Antenna Mounting Kit	11-21
11-7	AMK-02 Antenna Mounting Kit	11-25
11-8	Spectrum.....	11-37
11-9	Sweep.....	11-42
11-10	Manual.....	11-49
12-1	Front view 9010-RMA.....	12-2
12-2	Inside view 9010-RMA.....	12-3
12-3	PMM 9010-RMA with 9010 Instrument.....	12-7
15-1	PMM 9010F Functional BLOCK Diagram.....	15-8
15-2	Sweep Model.....	15-9
15-3	Spectrum.....	15-17
A-D-1	Receiver verification.....	A-D-2
A-D-2	Sweep.....	A-D-3
A-D-3	Network analyzer calibration Setup (L1)	A-D-5
A-D-4	Measurement Setup (L1)	A-D-5
A-D-5	L1-150M: Single line LISN, 150A LISN.....	A-D-6

Figure		Page
A-D-6	L2-16B: Two lines, Single phase, 16A LISN.....	A-D-6
A-D-7	L3-32: Four lines, 3-phase, 32A LISN.....	A-D-6
A-D-8	L3-64: Four lines, 3-phase, 64A LISN.....	A-D-6
A-D-9	L3-64/690: Four lines, 3-phase, 64A – 690Vac LISN.....	A-D-6
A-D-10	L3-100: Four lines, 3-phase, 100A LISN.....	A-D-6
A-D-11	L1-500: Single line LISN, 500A LISN.....	A-D-6
A-D-12	L3-500: Four lines, 3-phase, 500A LISN.....	A-D-6
A-D-13	Conversion table.....	A-D-7
A-D-14	PMM L2-16 model adapter.....	A-D-8
A-D-15	PMM L3-32 model adapter.....	A-D-8
A-D-16	PMM L3-64 model adapter.....	A-D-8
A-D-17	3-phase socket to BNC adapter.....	A-D-8
A-D-18	Rigid case.....	A-D-8
A-D-19	Rigid case internal view.....	A-D-8

Tables

Table		Page
1-1	Main Specifications 9010.....	1-3
9-1	9010/03P Main Specifications for C bands.....	9-5
9-2	9010/30P Main Specifications for CDE bands.....	9-8
9-3	9010/60P Main Specifications for CDE bands.....	9-11
10-1	Led status.....	10-14
11-1	Main Specifications 9030.....	11-3
11-2	Main Specifications 9060.....	11-6
11-3	Main Specifications 9180.....	11-9
12-1	Main Specifications 9010-RMA.....	12-2
15-1	Main Specifications 9010F.....	15-4

**⚠ WARNING****SAFETY RECOMMENDATIONS AND INSTRUCTIONS**

This unit has been designed and tested in Italy, according to IEC 348 standard and has left the manufacturer's premises in a state fully complying with the safety standards ; in order to maintain the unit in a safe state and to ensure safe operation, the following instructions must be reviewed and fully understood before operation.

- When the unit is to be permanently cabled, first connect an uninterruptible protective earth ground conductor before making any other connections.
- If the unit is to be connected to other equipment or accessories, prior to energizing either unit verify that a common ground exists between them.
- For permanently cabled unit without built-in fuses, automatic circuit breakers or similar protective facilities, the power supply line shall be provided with fuses or protections rated to the unit.
- Verify that the unit is set to match the available mains voltage and correct fuse rating is installed before applying power.
- The Safety Class I units provided with disconnectible AC supply cable and plug may only be operated from a power socket with protective earth ground connection.
- Any interruption or loosening of the protective earth ground conductor, either inside or outside the unit or in an extension cable will cause a potential shock hazard that could result in personal injury.
- The protective earth ground conductor shall not be interrupted intentionally.
- To avoid electrical shock do not remove protections or covers of the unit , refer to qualified NARDA Servicing Center for maintenance of the unit.
- To maintain adequate protection against fire hazard, replace fuses only with others of the same type and rating;
- Observe safety regulations and rules and also the additional safety instructions specified in this manual for prevention of accidents.

Dichiarazione di Conformità *EC Declaration of Conformity*

In accordo alla Decisione 768/2008/EC, conforme alle direttive EMC 2014/30/UE, Bassa Tensione 2014/35/UE e RoHS 2011/65/UE, ed anche alle norme ISO/IEC 17050-1 e 17050-2.
In accordance with the Decision 768/2008/EC, compliant to the Directives EMC 2014/30/UE, Low Voltage 2014/35/UE and RoHS 2011/65/EU, also compliant to the ISO/IEC standard 17050-1 and 17050-2

Il costruttore
The manufacturer **narda Safety Test Solutions S.r.l. Socio Unico**

Indirizzo
Address **Via Benessea, 29 / B**
I-17035 Cisano sul Neva (SV) - Italy

sulla base delle seguenti norme europee armonizzate, applicate con esito positivo:
based on the following harmonized European Standards, successfully applied:

EMC - Emissioni:
EMC - Emission: **EN 61326-1 (2013)**

EMC - Immunità:
EMC - Immunity: **EN 61326-1 (2013)**

Sicurezza:
Safety: **CEI EN 61010-1 (2010)**

dichiara, sotto la propria responsabilità, che il prodotto:
declares, under its sole responsibility, that the product:

Descrizione
Description **EMI CISPR RECEIVER**

Modello
Model **PMM 9010**

è conforme ai requisiti essenziali delle seguenti Direttive:
conforms with the essential requirements of the following Directives:

Bassa Tensione
Low Voltage **2014/35/EU**

Compatibilità Elettromagnetica
EMC **2014/30/EU**

RoHS
RoHS **2011/65/EU**

Cisano sul Neva, 03 May 2017

Egon Stocca
General Manager



Dichiarazione di Conformità *EC Declaration of Conformity*

In accordo alla Decisione 768/2008/EC, conforme alle direttive EMC 2014/30/UE, Bassa Tensione 2014/35/UE e RoHS 2011/65/UE, ed anche alle norme ISO/IEC 17050-1 e 17050-2.

In accordance with the Decision 768/2008/EC, compliant to the Directives EMC 2014/30/UE, Low Voltage 2014/35/UE and RoHS 2011/65/EU, also compliant to the ISO/IEC standard 17050-1 and 17050-2

Il costruttore
The manufacturer **narda Safety Test Solutions S.r.l. Socio Unico**

Indirizzo
Address **Via Benessea, 29 / B**

I-17035 Cisano sul Neva (SV) - Italy

sulla base delle seguenti norme europee armonizzate, applicate con esito positivo:
based on the following harmonized European Standards, successfully applied:

EMC - Emissioni:
EMC - Emission: **EN 61326-1 (2013)**

EMC - Immunità:
EMC - Immunity: **EN 61326-1 (2013)**

Sicurezza:
Safety: **CEI EN 61010-1 (2010)**

dichiara, sotto la propria responsabilità, che il prodotto:
declares, under its sole responsibility, that the product:

Descrizione
Description **EMI CISPR RECEIVER**

Modello
Model **PMM 9010F**

è conforme ai requisiti essenziali delle seguenti Direttive:
conforms with the essential requirements of the following Directives:

Bassa Tensione
Low Voltage **2014/35/EU**

Compatibilità Elettromagnetica
EMC **2014/30/EU**

RoHS
RoHS **2011/65/EU**

Cisano sul Neva, 03 May 2017

Egon Stocca
General Manager



Dichiarazione di Conformità *EC Declaration of Conformity*

In accordo alla Decisione 768/2008/EC, conforme alle direttive EMC 2014/30/UE, Bassa Tensione 2014/35/UE e RoHS 2011/65/UE, ed anche alle norme ISO/IEC 17050-1 e 17050-2.
In accordance with the Decision 768/2008/EC, compliant to the Directives EMC 2014/30/UE, Low Voltage 2014/35/UE and RoHS 2011/65/EU, also compliant to the ISO/IEC standard 17050-1 and 17050-2

Il costruttore
The manufacturer **narda Safety Test Solutions S.r.l. Socio Unico**

Indirizzo
Address **Via Benessea, 29 / B**
I-17035 Cisano sul Neva (SV) - Italy

sulla base delle seguenti norme europee armonizzate, applicate con esito positivo:
based on the following harmonized European Standards, successfully applied:

EMC - Emissioni:
EMC - Emission: **EN 61326-1 (2013)**

EMC - Immunità:
EMC - Immunity: **EN 61326-1 (2013)**

Sicurezza:
Safety: **CEI EN 61010-1 (2010)**

dichiara, sotto la propria responsabilità, che il prodotto:
declares, under its sole responsibility, that the product:

Descrizione
Description **EMI CISPR RECEIVER**

Modello
Model **PMM 9010/03P**

è conforme ai requisiti essenziali delle seguenti Direttive:
conforms with the essential requirements of the following Directives:

Bassa Tensione
Low Voltage **2014/35/EU**

Compatibilità Elettromagnetica
EMC **2014/30/EU**

RoHS
RoHS **2011/65/EU**

Cisano sul Neva, 03 May 2017

Egon Stocca
General Manager



Dichiarazione di Conformità *EC Declaration of Conformity*



In accordo alla Decisione 768/2008/EC, conforme alle direttive EMC 2014/30/UE, Bassa Tensione 2014/35/UE e RoHS 2011/65/UE, ed anche alle norme ISO/IEC 17050-1 e 17050-2.

In accordance with the Decision 768/2008/EC, compliant to the Directives EMC 2014/30/UE, Low Voltage 2014/35/UE and RoHS 2011/65/EU, also compliant to the ISO/IEC standard 17050-1 and 17050-2

Il costruttore
The manufacturer

narda Safety Test Solutions S.r.l. Socio Unico

Indirizzo
Address

Via Benessea, 29 / B

I-17035 Cisano sul Neva (SV) - Italy

sulla base delle seguenti norme europee armonizzate, applicate con esito positivo:
based on the following harmonized European Standards, successfully applied:

EMC - Emissioni:
EMC - Emission: **EN 61326-1 (2013)**

EMC - Immunità:
EMC - Immunity: **EN 61326-1 (2013)**

Sicurezza:
Safety: **CEI EN 61010-1 (2010)**

dichiara, sotto la propria responsabilità, che il prodotto:
declares, under its sole responsibility, that the product:

Descrizione
Description **EMI CISPR RECEIVER**

Modello
Model **PMM 9010/30P**

è conforme ai requisiti essenziali delle seguenti Direttive:
conforms with the essential requirements of the following Directives:

Bassa Tensione
Low Voltage **2014/35/EU**

Compatibilità Elettromagnetica
EMC **2014/30/EU**

RoHS
RoHS **2011/65/EU**

Cisano sul Neva, 03 May 2017

Egon Stocca
General Manager

Dichiarazione di Conformità *EC Declaration of Conformity*

In accordo alla Decisione 768/2008/EC, conforme alle direttive EMC 2014/30/UE, Bassa Tensione 2014/35/UE e RoHS 2011/65/UE, ed anche alle norme ISO/IEC 17050-1 e 17050-2.
In accordance with the Decision 768/2008/EC, compliant to the Directives EMC 2014/30/UE, Low Voltage 2014/35/UE and RoHS 2011/65/EU, also compliant to the ISO/IEC standard 17050-1 and 17050-2

Il costruttore
The manufacturer **narda Safety Test Solutions S.r.l. Socio Unico**

Indirizzo
Address **Via Benessea, 29 / B**

I-17035 Cisano sul Neva (SV) - Italy

sulla base delle seguenti norme europee armonizzate, applicate con esito positivo:
based on the following harmonized European Standards, successfully applied:

EMC - Emissioni:
EMC - Emission: **EN 61326-1 (2013)**

EMC - Immunità:
EMC - Immunity: **EN 61326-1 (2013)**

Sicurezza:
Safety: **CEI EN 61010-1 (2010)**

dichiara, sotto la propria responsabilità, che il prodotto:
declares, under its sole responsibility, that the product:

Descrizione
Description **EMI CISPR RECEIVER**

Modello
Model **PMM 9010/60P**

è conforme ai requisiti essenziali delle seguenti Direttive:
conforms with the essential requirements of the following Directives:

Bassa Tensione
Low Voltage **2014/35/EU**

Compatibilità Elettromagnetica
EMC **2014/30/EU**

RoHS
RoHS **2011/65/EU**

Cisano sul Neva, 03 May 2017

Egon Stocca
General Manager



Dichiarazione di Conformità *EC Declaration of Conformity*



In accordo alla Decisione 768/2008/EC, conforme alle direttive EMC 2014/30/UE, Bassa Tensione 2014/35/UE e RoHS 2011/65/UE, ed anche alle norme ISO/IEC 17050-1 e 17050-2.

In accordance with the Decision 768/2008/EC, compliant to the Directives EMC 2014/30/UE, Low Voltage 2014/35/UE and RoHS 2011/65/EU, also compliant to the ISO/IEC standard 17050-1 and 17050-2

Il costruttore
The manufacturer

narda Safety Test Solutions S.r.l. Socio Unico

Indirizzo
Address

Via Benessea, 29 / B

I-17035 Cisano sul Neva (SV) - Italy

sulla base delle seguenti norme europee armonizzate, applicate con esito positivo:
based on the following harmonized European Standards, successfully applied:

EMC - Emissioni:
EMC - Emission: **EN 61326-1 (2013)**

EMC - Immunità:
EMC - Immunity: **EN 61326-1 (2013)**

Sicurezza:
Safety: **CEI EN 61010-1 (2010)**

dichiara, sotto la propria responsabilità, che il prodotto:
declares, under its sole responsibility, that the product:

Descrizione
Description

EMI CISPR RECEIVER EXTENSION

Modello
Model

PMM 9030

è conforme ai requisiti essenziali delle seguenti Direttive:
conforms with the essential requirements of the following Directives:

Bassa Tensione
Low Voltage **2014/35/EU**

Compatibilità Elettromagnetica
EMC **2014/30/EU**

RoHS
RoHS **2011/65/EU**

Cisano sul Neva, 03 May 2017

Egon Stocca
General Manager

Dichiarazione di Conformità *EC Declaration of Conformity*

In accordo alla Decisione 768/2008/EC, conforme alle direttive EMC 2014/30/UE, Bassa Tensione 2014/35/UE e RoHS 2011/65/UE, ed anche alle norme ISO/IEC 17050-1 e 17050-2.
In accordance with the Decision 768/2008/EC, compliant to the Directives EMC 2014/30/UE, Low Voltage 2014/35/UE and RoHS 2011/65/EU, also compliant to the ISO/IEC standard 17050-1 and 17050-2

Il costruttore
The manufacturer **narda Safety Test Solutions S.r.l. Socio Unico**

Indirizzo
Address **Via Benessea, 29 / B**

I-17035 Cisano sul Neva (SV) - Italy

sulla base delle seguenti norme europee armonizzate, applicate con esito positivo:
based on the following harmonized European Standards, successfully applied:

EMC - Emissioni:
EMC - Emission: **EN 61326-1 (2013)**

EMC - Immunità:
EMC - Immunity: **EN 61326-1 (2013)**

Sicurezza:
Safety: **CEI EN 61010-1 (2010)**

dichiara, sotto la propria responsabilità, che il prodotto:
declares, under its sole responsibility, that the product:

Descrizione
Description **EMI CISPR RECEIVER EXTENSION**

Modello
Model **PMM 9060**

è conforme ai requisiti essenziali delle seguenti Direttive:
conforms with the essential requirements of the following Directives:

Bassa Tensione
Low Voltage **2014/35/EU**

Compatibilità Elettromagnetica
EMC **2014/30/EU**

RoHS
RoHS **2011/65/EU**

Cisano sul Neva, 03 May 2017

Egon Stocca
General Manager



XX

Safety considerations

Dichiarazione di Conformità *EC Declaration of Conformity*

In accordo alla Decisione 768/2008/EC, conforme alle direttive EMC 2014/30/UE, Bassa Tensione 2014/35/UE e RoHS 2011/65/UE, ed anche alle norme ISO/IEC 17050-1 e 17050-2.

In accordance with the Decision 768/2008/EC, compliant to the Directives EMC 2014/30/UE, Low Voltage 2014/35/UE and RoHS 2011/65/EU, also compliant to the ISO/IEC standard 17050-1 and 17050-2

Il costruttore
The manufacturer **narda Safety Test Solutions S.r.l. Socio Unico**

Indirizzo
Address **Via Benessea, 29 / B**

I-17035 Cisano sul Neva (SV) - Italy

sulla base delle seguenti norme europee armonizzate, applicate con esito positivo:
based on the following harmonized European Standards, successfully applied:

EMC - Emissioni:
EMC - Emission: **EN 61326-1 (2013)**

EMC - Immunità:
EMC - Immunity: **EN 61326-1 (2013)**

Sicurezza:
Safety: **CEI EN 61010-1 (2010)**

dichiara, sotto la propria responsabilità, che il prodotto:
declares, under its sole responsibility, that the product:

Descrizione
Description **EMI CISPR RECEIVER EXTENSION**

Modello
Model **PMM 9180**

è conforme ai requisiti essenziali delle seguenti Direttive:
conforms with the essential requirements of the following Directives:

Bassa Tensione
Low Voltage **2014/35/EU**

Compatibilità Elettromagnetica
EMC **2014/30/EU**

RoHS
RoHS **2011/65/EU**

Cisano sul Neva, 03 May 2017

Egon Stocca
General Manager



Dichiarazione di Conformità *EC Declaration of Conformity*

In accordo alla Decisione 768/2008/EC, conforme alle direttive EMC 2014/30/UE, Bassa Tensione 2014/35/UE e RoHS 2011/65/UE, ed anche alle norme ISO/IEC 17050-1 e 17050-2.
In accordance with the Decision 768/2008/EC, compliant to the Directives EMC 2014/30/UE, Low Voltage 2014/35/UE and RoHS 2011/65/EU, also compliant to the ISO/IEC standard 17050-1 and 17050-2

Il costruttore
The manufacturer **narda Safety Test Solutions S.r.l. Socio Unico**

Indirizzo
Address **Via Benessea, 29 / B**

I-17035 Cisano sul Neva (SV) - Italy

sulla base delle seguenti norme europee armonizzate, applicate con esito positivo:
based on the following harmonized European Standards, successfully applied:

EMC - Emissioni:
EMC - Emission: **EN 61326-1 (2013)**

EMC - Immunità:
EMC - Immunity: **EN 61326-1 (2013)**

Sicurezza:
Safety: **CEI EN 61010-1 (2010)**

dichiara, sotto la propria responsabilità, che il prodotto:
declares, under its sole responsibility, that the product:

Descrizione
Description **Switching Operation Box**

Modello
Model **PMM 9010 Click**

è conforme ai requisiti essenziali delle seguenti Direttive:
conforms with the essential requirements of the following Directives:

Bassa Tensione
Low Voltage **2014/35/EU**

Compatibilità Elettromagnetica
EMC **2014/30/EU**

RoHS
RoHS **2011/65/EU**

Cisano sul Neva, 20 April 2016 Egon Stocca
 General Manager



Dichiarazione di Conformità *EC Declaration of Conformity*



In accordo alla Decisione 768/2008/EC, conforme alle direttive EMC 2014/30/UE, Bassa Tensione 2014/35/UE e RoHS 2011/65/UE, ed anche alle norme ISO/IEC 17050-1 e 17050-2.

In accordance with the Decision 768/2008/EC, compliant to the Directives EMC 2014/30/UE, Low Voltage 2014/35/UE and RoHS 2011/65/EU, also compliant to the ISO/IEC standard 17050-1 and 17050-2

Il costruttore
The manufacturer

narda Safety Test Solutions S.r.l. Socio Unico

Indirizzo
Address

Via Benessea, 29 / B

I-17035 Cisano sul Neva (SV) - Italy

**sulla base delle seguenti norme europee armonizzate, applicate con esito positivo:
*based on the following harmonized European Standards, successfully applied:***

EMC - Emissioni:
EMC - Emission:

EN 61326-1 (2013)

EMC - Immunità:
EMC - Immunity:

EN 61326-1 (2013)

Sicurezza:
Safety:

CEI EN 61010-1 (2010)

**dichiara, sotto la propria responsabilità, che il prodotto:
*declares, under its sole responsibility, that the product:***

Descrizione
Description

**Misuratore di Click 4 Canali Opzionale
Four Channels Click Meter Option**

Modello
Model

PMM 9010/Click4E

**è conforme ai requisiti essenziali delle seguenti Direttive:
*conforms with the essential requirements of the following Directives:***

Bassa Tensione
Low Voltage

2014/35/EU

Compatibilità Elettromagnetica
EMC

2014/30/EU

RoHS
RoHS

2011/65/EU

Cisano sul Neva, 03 May 2017

Egon Stocca

General Manager

This page has been left blank intentionally

1 – General Information

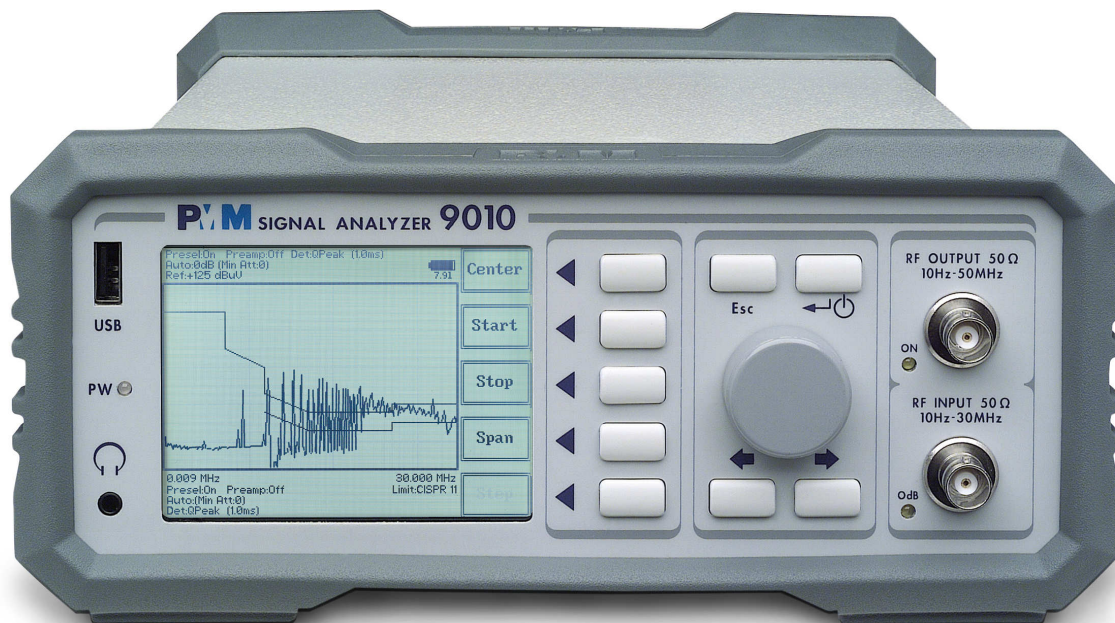

1.1 Documentation

Enclosed with this manual are:

- a service questionnaire to send back to NARDA in case an equipment service is needed
- an accessories checklist to verify all accessories enclosed in the packaging.

1.2 Operating Manual Changes

Instruments manufactured after the printing of this manual may have a serial number prefix not listed on the title page; this indicates that instruments with different Serial Number prefix may be different from those documented in this manual.

1.3 Introduction to PMM 9010

PMM 9010 is a powerful EMI receiver, fully CISPR 16-1-1, to measure conducted and radiated interferences from 10 Hz up to 30 MHz, or even up to 3/6/18 GHz when matched with PMM 9030/9060/9180 extension unit (optional). All measurements performed by the PMM 9010 are according to the most accepted standards like: IEC, CISPR, EN (EuroNorm), FCC, VDE,..

Thanks to its built-in tracking generator, PMM 9010 is also suitable for designing, characterizing and testing RF filters, transducers and other components.

The PMM 9010 has been designed adopting an innovative philosophy made possible only in the recent years by the availability of superior technology components. This equipment is fully digital but the input preselector and attenuator – and, of course, the output stage of the internal reference tracking generator - and therefore combines into a pure EMI Receiver and Signal Analyzer the precision and accuracy of a numeric approach, with flexibility and user friendly approach typical of a modern instrument.

1.4 Instrument Items

PMM 9010 includes the following items:

- EMI Receiver from 10 Hz up to 30 MHz
- BP-02 Li-ion battery pack;
- AC/DC Converter with plug adapters;
- Flexible black cover/accessories holding;
- BNC-BNC coaxial cable 2m length;
- RS232 cable, 2m;
- USB-RS232 serial converter;
- USB cable, 2m;
- Operating manual;
- PMM 9010 Utility Software on Software Media;
- Certificate of Compliance;
- Return for Repair Form.

1.5 Optional accessories

PMM 9010 can be used with several optional accessories, the most common being the following:

- PMM 9030 EMI receiver 30 MHz - 3 GHz;
- PMM 9060 EMI receiver 30 MHz - 6 GHz;
- PMM 9180 EMI receiver 6 GHz - 18 GHz;
- Single Channel Click option;
- PMM 9010-RMA Rack Mount Adapter for Rack 19"
- L2-16B: Two lines, Single phase, 16A LISN, (50Ω//5 Ω+50μH);
- L3-32: Four lines, 3-phase, 32A LISN, (50Ω//5 Ω+50μH);
- L3-64: Four lines, 3-phase, 64A LISN, (50Ω//5 Ω+50μH);
- L3-64/690: Four lines, 3-phase, 64A - 690Vac LISN, (50Ω//5 Ω+50μH);
- L3-100: Four lines, 3-phase, 100A LISN, (50Ω//5 Ω+50μH);
- L1-150M: Single line LISN, 150A (50Ω//1 Ω+5μH);
- L1-150M1: Single line LISN, 150A (50Ω//1 Ω+5μH);
- L1-500: Single line LISN, 500A LISN, (50Ω//5 Ω+50μH);
- L3-500: Four lines, 3-phase, 500A LISN, (50Ω//5 Ω+50μH);
- SBRF4 RF Switching Box (Switching Box for LISNs and Loop Antennas)
- LISN Service Kit (AC-BNC adapter for LISNs verification and calibration)
- SHC-1/1000: 35 dB CISPR Voltage probe, 1500Ω;
- SHC-2/1000: 30 dB CISPR Voltage probe, 1500Ω;
- RA-01: Rod Antenna (9 kHz – 30 MHz);
- RA-01-MIL: Rod Antenna (9 kHz – 30 MHz);
- RA-01-HV: Rod Antenna (150 kHz – 30 MHz);

1.6 Other accessories

Of course, the PMM 9010 can be used with other accessories available on the market, like:

- LISNs, any type;
- Antennas and Loops;
- Near Field Probes;
- Various TEM/GTEM Cells;
- HXYZ 9170 Triple Loop Antenna
- GPIB to RS232 Adapter.

1.7 Main Specifications

Table 1-1 lists the PMM 9010 performance specifications.

The following conditions apply to all specifications:

- The ambient temperature shall be 0°C to 40°C

TABLE 1-1 Main Specifications

Frequency range	10 Hz to 30 MHz (CISPR-16-1-1 Full-Compliance from 9 kHz to 30 MHz)
Resolution	0,1 Hz
Frequency accuracy	< 1 ppm
RF input	Z_{in} 50 Ω , BNC fem.
VSWR	
≥ 10 dB RF att.	< 1.2
0 dB RF att.	< 2.0
Attenuator	0 dB to 35 dB (5dB steps)
Pulse limiter	Built in (selectable)
Preamplifier gain	20 dB (after preselector, selectable)
Max input level (without equipment damage)	
Sinewave AC voltage	137 dBuV (1 W)*
Pulse spectral density	97 dB μ V/MHz
Preselector	
One lowpass filter	< 9 kHz
Six bandpass filters	9 kHz to 150 kHz 150kHz to 500 kHz 500kHz to 3 MHz 3 MHz to 10 MHz 10 MHz to 20 MHz 20 MHz to 30 MHz
IF bandwidth	
Standard 3 dB	3, 10, 30, 100, 300 kHz
CISPR 16-1-1 bandwidth (6 dB)	0.2 and 9 kHz
MIL-STD-461 (option)	10, 100 Hz, 1, 10 kHz

(*) with MIN ATT ≥ 10 dB



Noise level (preamplifier ON)	
9 to 150 kHz (200 Hz BW)	< -8 dB μ V (QP); < -15 dB μ V (AV)
150 kHz to 30 MHz (9 kHz BW)	< -4 dB μ V (QP); < -10 dB μ V (AV)
Measuring Detectors	Peak, Quasi-peak, Average, RMS, RMS-Average, CISPR-Average, APD and Smart Detector function
Level measuring time	
Peak, Quasi-peak, Average, RMS (simultaneous detectors)	1 ms to 30 sec. (CISPR 16-1-1 default)
Display units	dBm, dB μ V (as stand-alone); dBm, dB μ V, dB μ V/m, dBmA, dBmA/m, dBpW (through 9010 SW Utility on PC)
Spurious response	< 0 dBuV, < 10 dBuV over 150 kHz
Spectrum	
Span/division	From 100 Hz to 3 MHz
Measurement accuracy	
S/N > 20 dB	10 Hz to 9 kHz \pm 1.0 dB typical 9 kHz to 30 MHz \pm 1.0 dB
Demodulation	Built-in AM demodulator (earphones jack output)
RF output (Tracking Generator)	
	Z _{out} 50 Ω , BNC fem.
Frequency range	10 Hz to 50 MHz
Level	60 dB μ V to 90 dB μ V (0.1 dB steps)
Level accuracy (10 Hz to 30 MHz)	\pm 0.5 dB
I/O Interface	USB 2.0 (rear); USB 2.0 (front; only for future implementation); RS-232; High Speed Optical Link (2 channels; 2nd channel for future implementation); User Port (for LISNs connection, etc.); IEEE-488 (GPIB) optional
Operating temperature	0° to 40°C
Power supply	10 - 15 Volt DC, 2,5A; Li-Ion interchangeable battery (8 h operations, typical)
Dimensions	235 x 105 x 335 mm
Weight	4.1 kg

1.8 Front Panel

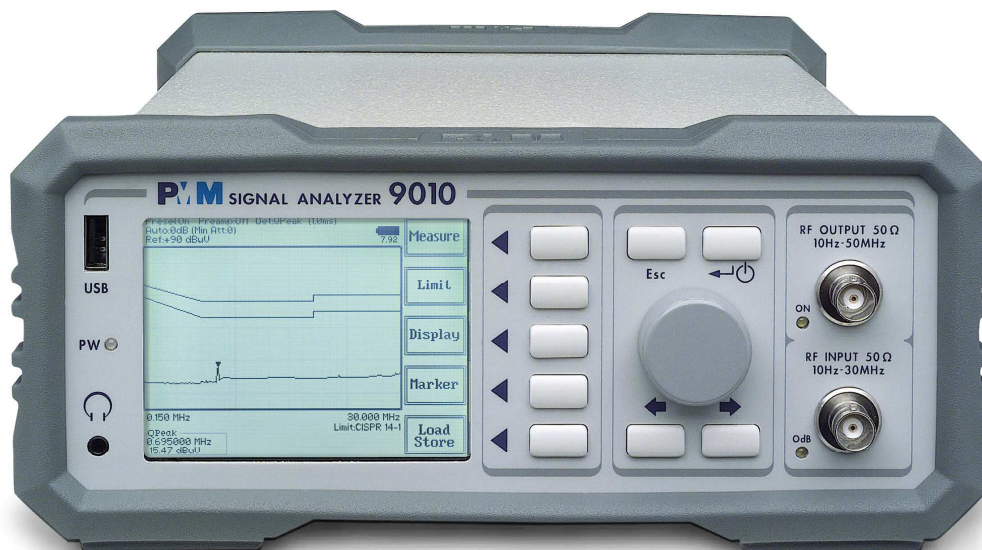



Fig. 1-1 Front Panel

Legend from left to right:

- **USB** USB 2.0 connection port (future implementation only)
- **PW** Power led
Indicates the power status
-  Earphone connector
To listen to the demodulated signals
- **DISPLAY** Main display
To graphically show the instrument status
- **User keys** 5 command keys
To select the various available functions
- **Controls** Rotary Knob, Left and Right (decrease / increase) Arrow Keys; Esc; Enter/Switch Key
The Rotary Knob and the Arrows Keys can be used to increase and decrease the setting values; the Esc key allows to return to the previous status/display; the Enter/switch key is used to confirm a set value and to switch On and Off the equipment
- **Input and Output connectors**
Tracking Generator Output and Receiver Input
- **RF Output led "ON"**
Indicates when the internal generator is switched ON
- **RF Input led "0dB"**
Is ON when the input attenuator has been set to 0 dB; blinking when PMM 9030/9060/9180 is connected through fiber optic cable and properly communicating with 9010

1.9 Rear Panel



Fig. 1-2 Rear Panel

Legend from left to right:

- **RS232** 9 pin, DB9 connector
- **GPIB** IEEE488 I/O Port (optional)
- **USER PORT** User I/O Port
- **USB** Fully functional USB 2.0 Port
- **LINK1/LINK2** Optical link connectors for PMM equipments (Link 2 for future implementation)
- **Power Supply** Power Supply Inputs for use to power the apparatus and simultaneously charge its battery (PS1) and to simply charge the battery when it's out of the receiver (PS2).
- **Fan** Cooling Fan controlled by firmware
- **Replaceable Li-Ion Battery (Fig. 1-3) with main Battery Charger connector**
- **Earth ground connector**
- **Product Label and Serial Number**



Fig. 1-3 BP-02 Replaceable Battery

1.10 Functional Description

The PMM 9010 features a completely new receiver architecture based on the most recent DSP and RSP technology, as shown on the diagram below. The PMM 9010 diagram is shown in Fig. 1-4

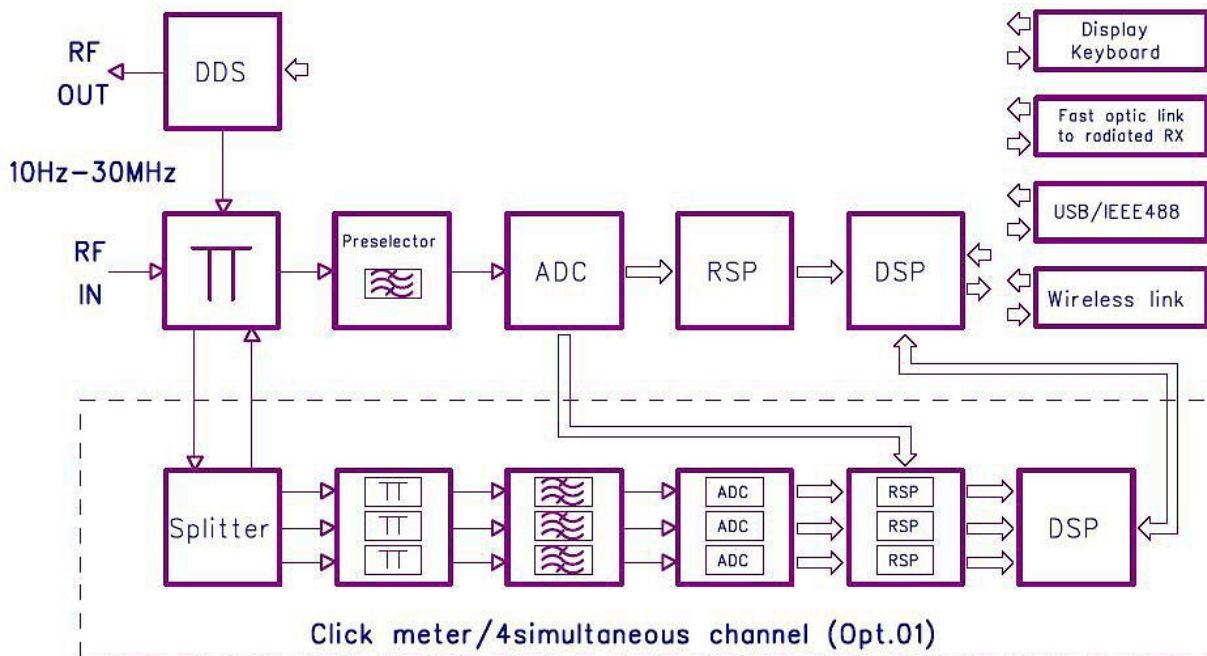

Fig. 1-4 PMM 9010 Functional BLOCK Diagram

1.11 Ultra fast measurement: a unique feature of the PMM 9010

In the CISPR band A (9 ÷ 150 kHz), the standards requires the use of a 200 Hz filter that is, by nature, a filter that implies a long measurement time: a complete scan may require even more than 10 minutes, depending the detector in use.

Thanks to its architecture and to the large internal memory capability, the PMM 9010 can take a “snapshot” of the whole band in just one second and, using a true built-in FFT capability, perfectly displays the complete band in all its details. Later on will be then possible to make the QuasiPeak evaluation of all the frequencies of interest after the measurements will be taken.

This feature is not only useful to greatly increase the productivity of the test lab, but also to make better and more comprehensive analysis in case the disturbance to be evaluated is somehow intermittent and with an irregular repetition rate; its analysis with a traditional receiver could be hardly made in a proper way (even if an FFT capability is available: this feature needs a very comprehensive design), as irregular pulses could be lost during a usual sweep.

To be noted that during the FFT analysis the PMM 9010 makes use of internal standard Gaussian filters in compliance with the norms, while in other cases it uses filters mathematically modelled to the perfection using a FIR technique.

1.12 Emission measurements

All electric and electronic devices are potential generators of Electro-Magnetic Interference (EMI).

The term EMI thus refers to the electromagnetic energy emitted by a device which propagates itself along cables or through the air and couples with other devices that are present in the surroundings.

These electromagnetic fields (conducted or radiated interferences) may generate interfering currents and voltages into nearby equipment and therefore can cause possible malfunctions.

In order to prevent and control such interferences there are nowadays a number of national and international standards, like IEC and CISPR, which specifies limits and methods of tests. Moreover, within the European Union the application of several European Norms on Electromagnetic Compatibility is enforced by law and therefore the commercialization and use of all the electric and electronic equipment is subject to the measurement of the EMC characteristics, which must be within well defined limits.

The design approach adopted for the PMM 9010 is that the instrument shall be innovative, full compliant with all the relevant standards and at the same time simple and reliable to use, to be the base building block for any possible emission system to measure and evaluate any electric or electronic device from the very first design stages to the final certification.

The need to precisely measure the conducted and radiated EMI noises forces the equipment manufactures to use reliable equipment to verify the limits imposed by the relevant standards and/or enforced by local rules.

In this view the PMM 9010 receiver is the ideal solution from prototype debugging to final certification, as it fully meets all the performance criteria dictated by these standards, although it remains small, lightweight and very easy to use.

The PMM 9010 Utility control software permits an immediate use of the instrument without any training or special difficulties: the operator can concentrate just on analyzing the measurement results.

Moreover, the PMM 9010 software has also been designed for a fast and easy installation on any PC with the Windows™ operating system and with at least one free USB or Serial Port.

The device under test (DUT) must be installed according to the procedures indicated in the constructor's manual and normal operating conditions respected.



Be sure not to overload PMM 9010: the input signal should not exceed the maximum level indicated in the main specifications in chapter 1. Also do not apply any signal to RF generator output connector.

2 - Installation

2.1 Introduction

This section provides the information needed to install your PMM 9010. It includes the information pertinent to initial inspection and power requirements, connections, operating environment, instrument mounting, cleaning, storage and shipment.

2.2 Initial Inspection

When receiving the equipment, first inspect the shipping cardbox for any damages. If the shipping box is damaged, it should be kept until the contents of the shipment have been checked for completeness and the instrument has been checked mechanically and electrically.

2.3 Packing and Unpacking

Verify the availability of all the shipped items with reference to the shipping check list enclosed with the Operating Manual. Notify any damage to the forwarder personnel as well as to your NARDA Representative.



WARNING

To avoid further damage, do not turn on the instrument when there are signs of shipping damage to any portion of it.

2.4 Preparation for Use



WARNING

This is a Safety Class I apparatus, but it is also equipped with a protective/functional earth terminal on the rear panel. A good safety/functional ground connection should be provided before to operate the receiver.

2.5 Battery charger

The battery charger supplied with the receiver can work at either 50 Hz or 60 Hz with a supply voltage rated between 100 and 240 Volt. It is supplied with different connectors to fit all the possible outlets in accordance with the various National standards.



Battery charger: DC, 10 - 15 V, ~ 2500 mA
=> DC Connector

2.5.1 To replace the mains connector of the battery charger

To replace the mains connector, simply remove the one installed on the battery charger sliding it off, and insert the one that fits the outlets in use.

2.5.2 To charge the internal battery

In order to guarantee the best autonomy of the internal battery, we recommend to fully recharge it before using the receiver. To charge the battery, simply connect the battery charger to the mains power socket and insert the DC output connector of the battery charger to the input **CHARGER** on the rear panel of the receiver.

2.7 Return for Service

If the instrument should be returned to NARDA for service, please complete the service questionnaire enclosed with the Operating Manual and attach it to the instrument.

To minimize the repair time, be as specific as possible when describing the failure. If the failure only occurs under certain conditions, explain how to duplicate the failure.

If possible, reusing of the original packaging to ship the equipment is preferable.

In case other package should be used, ensure to wrap the instrument in heavy paper or plastic.

Use a strong shipping box and use enough shock absorbing material all around the equipment to provide a firm cushion and prevent movement in the shipping box; in particular protect the front panel.

Seal the shipping box securely.

Mark the shipping box FRAGILE to encourage careful handling.



Nowadays there are restrictions on the shipment of hazardous materials, eg. some types of lithium batteries.

Please, check the proper, safe, shipping mode, with the help of your courier, in the case the product is equipped with batteries.

2.8 Equipment Cleaning

Use a clean, dry, non abrasive cloth for external cleaning of the equipment.



To clean the equipment do not use any solvent, thinner, turpentine, acid, acetone or similar matter to avoid damage to external plastic or display surfaces.

2.9 Equipment ventilation



To allow correct equipment ventilation ensure that the vent grids on the rear panel and on the bottom of the receiver are free by any obstructing object.

2.10 Hardware Installation

PMM 9010 is delivered from factory ready to use. Remove the receiver from its cardboard shipping box and keep the "ON" button pressed until the PW Led lights up (about 1 second), then release the button. To avoid unwanted starts, if the "ON" button is kept pressed for a too short time or for more then 2 seconds the instrument is switched automatically off.

After having been switched ON, the PMM 9010 boots with its internal BIOS and runs the firmware which manages the receiver.

At the beginning the instrument performs a diagnostic test to check if everything is working properly.

The boot sequence is very fast and the receiver is ready to use in a couple of seconds after having pressed the ON button.

Before to see the main menu on the LCD display, you will see all the front panel LED's flashing ON and OFF.

During the switch-on procedure the LCD displays the results of the autotest and the release – and date - of the loaded firmware: if the display shows "OK" it means that the PMM 9010 is working properly. When the sequence is completed the main screen shows the test results and the main functional keys on the right of the LCD display: the receiver is now ready to operate.

Connect the output of any LISN, or antenna, or absorbing clamp or any other transducers to the RF input.

When using a PMM LISN, it is possible to control from the receiver the lines of the LISN and automatically switch between them connecting a special cable between the User Port of the receiver and the LISN remote control input.

Push and keep pressed the “ON/OFF” button for more then 2 seconds to switch off the receiver.

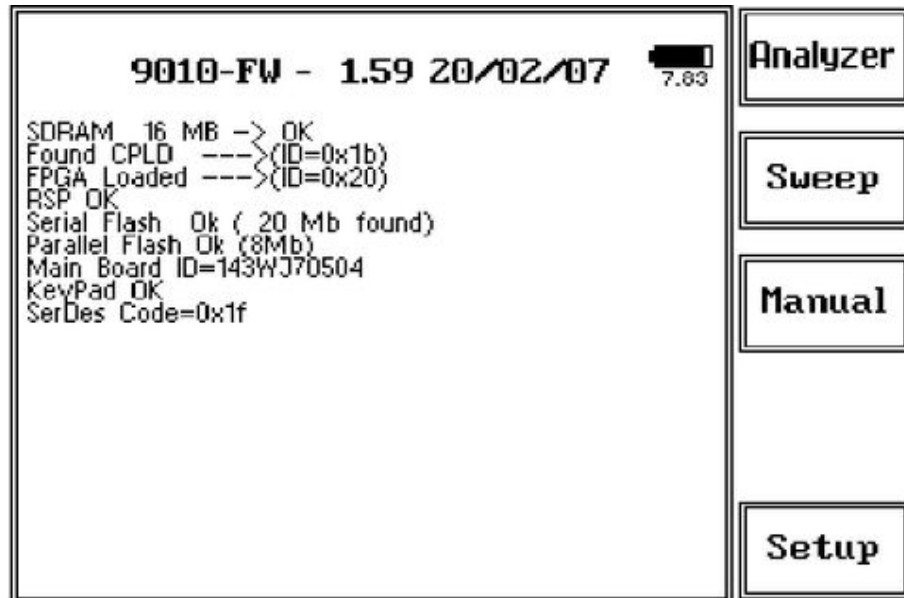

Fig. 2-1 PMM 9010 initial screen showing the results of the initial self-test and the five main function keys menu.

2.11 Using an Artificial Mains Network (AMN or LISN)

When the PMM 9010 receiver is connected to a LISN to perform conducted interference measurements of the EUT, the RF output of the LISN shall be connected to the RF input of the receiver. In order to switch automatically between the lines of the LISN, it shall be connected to the User Port of the receiver thanks to the dedicated cable supplied with the LISN .

Using PMM 9010 Software Utility it is possible to carry out an automatic measurements on all mains lines and get the worst case.



In order to avoid the unwanted tripping of the protection devices, an insulation transformer shall always be used between the mains supply and a LISN.

2.12 Using the Pulse Limiter

The built in pulse limiter is a useful device to protect the input of the receiver from transient over voltages. Sometime the conducted disturbances entering the receiver through the LISN are too high - even if they cannot be seen on the PMM 9010 because they are out of measurement bandwidth - and the associate energy is high enough to damage the input circuit.

The pulse limiter shall be used only as a protection of the input from unexpected pulses.



When using an external Artificial Mains Network, to reduce the probability of damages caused by transient voltage pulses always disconnect the PMM 9010 RF input before switching Equipment Under Test supply ON or OFF.

2.13 Using Current and Voltage Probes

When a LISN cannot be used – e.g. when measurements have to be made on terminals other than the mains ones, such as load or command terminals, sensitive to inserted capacities for example, or when LISNs of adequate current capabilities aren't available, or when the line voltage is too high – a current or voltage probe can be used.

The characteristics of these probes, and some advises on their uses, are given in §5 of CISPR 16-1-2.

The CISPR voltage probe contains a resistor with a minimum resistance of 1500 ohm, in series with a capacitor of negligible reactance vs. the resistance (in the 150 kHz to 30 MHz range), and it is insulated at least up to 1500V.

All these probes have an insertion loss and a frequency response that can be stored in the memory of the PMM 9010, so that the actual readings of the receiver can be automatically corrected by these characteristics values.

2.14 Using Antennas and other Transducers

In the frequency range from 10 Hz to 30 MHz any other transducer can be used to pick-up and measure RF conducted and radiated emissions, like active and passive loop antennas, rod antennas, near field probes etc.

The characteristics of these transducers are usually specified in the relevant standards (e.g. Military or Automotive Standards).

Their use with PMM 9010 is very easy, as it's enough to enter their response with the frequency into the memory of the receiver to have the readings automatically corrected. When the cable is not calibrated together with the transducer, even the cable loss can be entered.

2.15 The User Port

The PMM 9010 features on the rear panel a programmable User Port that can be used to drive external devices or, more generally, to output signals and data.

The User Port can easily be programmed and managed; the connector has the following hardware connection:

PIN #	Signal
1	IN3
2	IN1
3	+ 12 VDC (max 50 mA)
4	OUT 0
5	OUT 2
6	OUT 4
7	USR-MISO
8 and 9	IN 2
10	IN 0
11	GND
12	OUT 1
13	OUT 3
14	USR-MOSI
15	USR-CLK

Data output (OUT 0 to OUT 4) and input (IN 0 to IN 3) are opto-coupled TTL level with max. 1 mA draining.

Every other detail about User Port functionality is described in a separate and more specific manual, available upon request.

2.16 PMM L2-16A Remote Cable configuration for PMM 9010



The following figure shows the LISN remote cable pin configuration. This cable is normally provided in L2-16A package, alternatively it can be requested to Narda or arranged locally.

The PMM L2-16A is no longer supported. Please, check the manufacturing status of the Narda products from the website at <http://www.narda-sts.it> or contact your Narda – PMM local Dealer

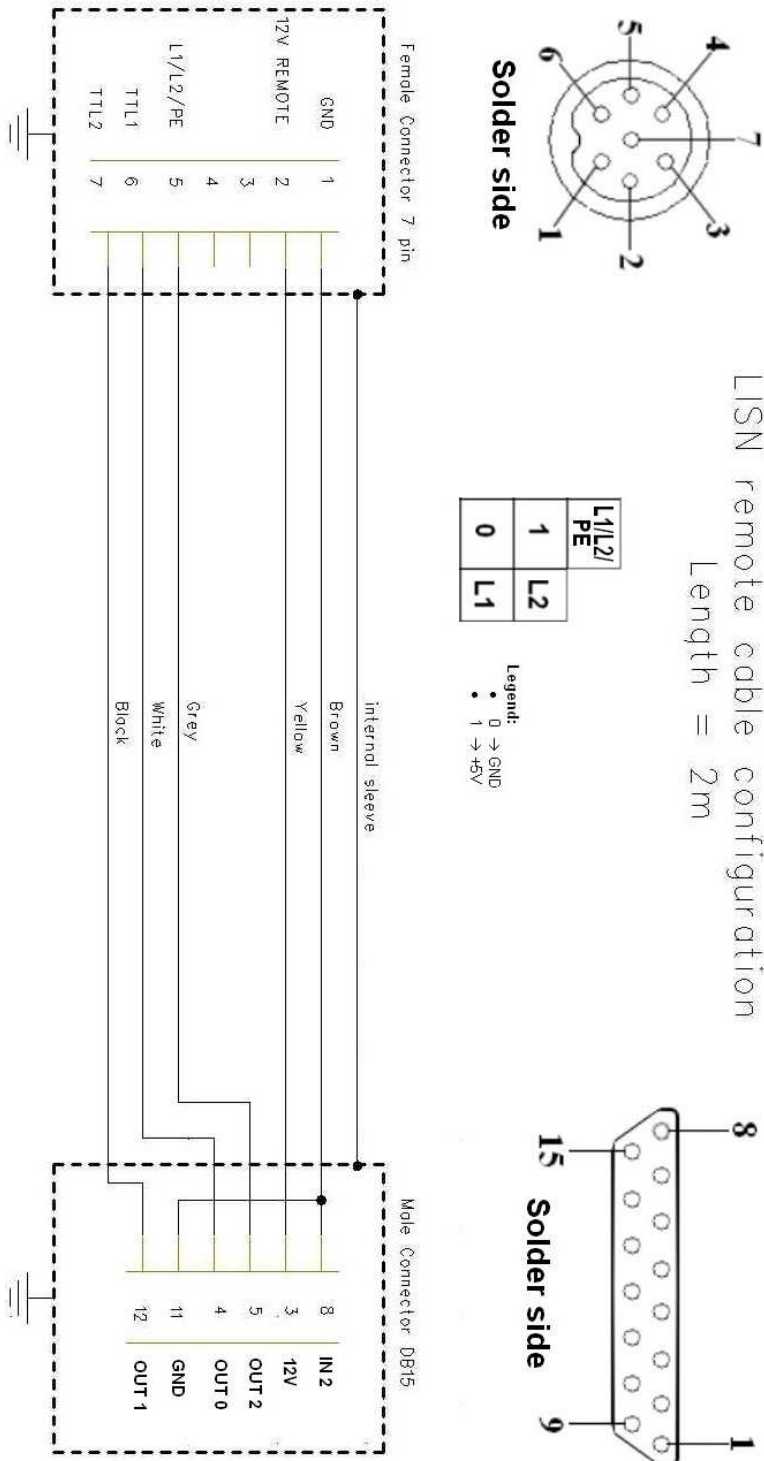

Fig. 2-2 PMM L2-16A remote cable configuration for PMM 9010

**2.17 PMM LISNs
Three Phase
Remote Cable
configuration
for PMM 9010
(L3-25 excluded)**

The following figure shows the LISN remote cable pin configuration. The cable can be requested to Narda or arranged locally.

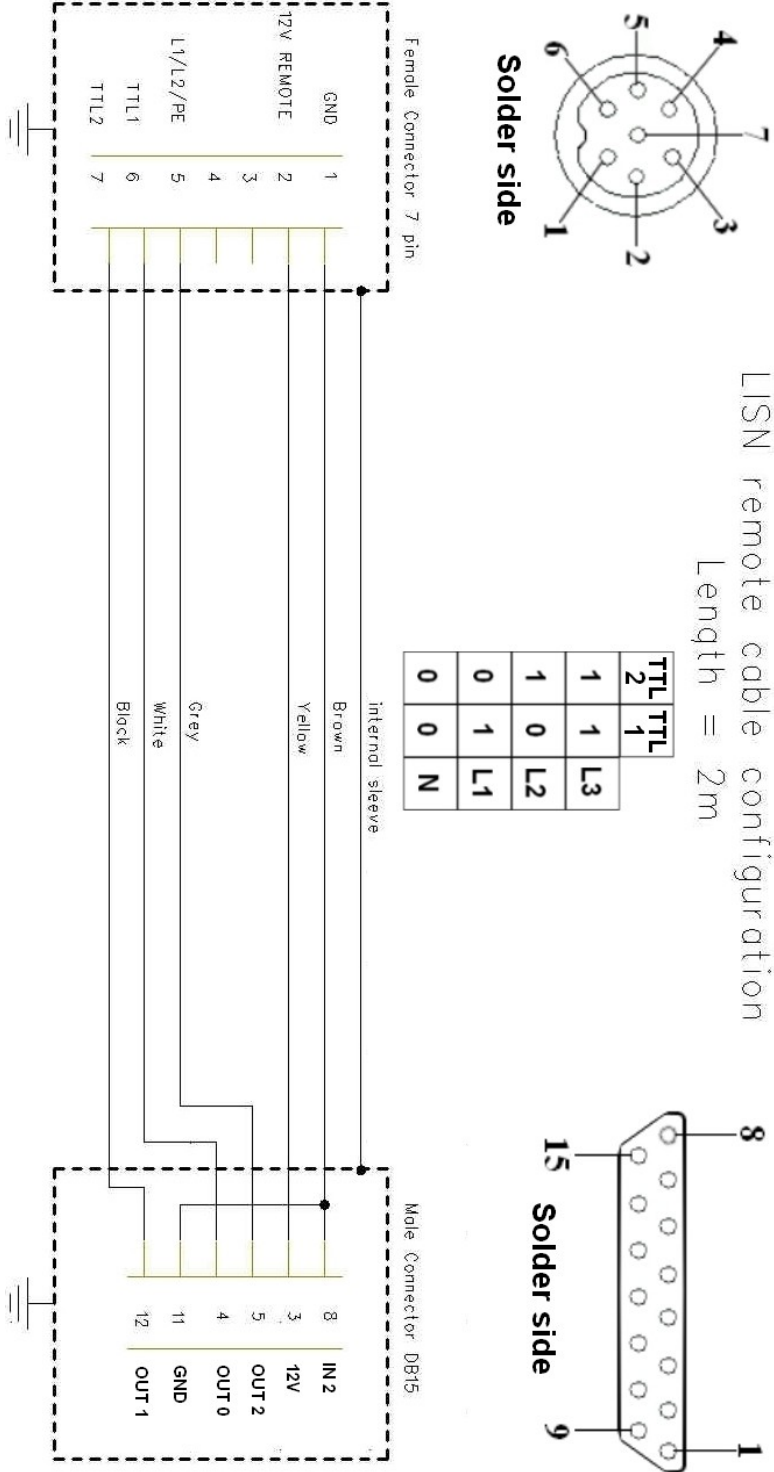

Fig. 2-3 PMM LISN three phase remote cable configuration for PMM 9010

2.18 PMM L2-16 Remote Cable configuration for PMM 9010



The following figure shows the LISN remote cable pin configuration. The cable can be requested to Narda or arranged locally.

The PMM L2-16 is no longer supported. Please, check the manufacturing status of the Narda products from the website at <http://www.narda-sts.it> or contact your Narda – PMM local Dealer

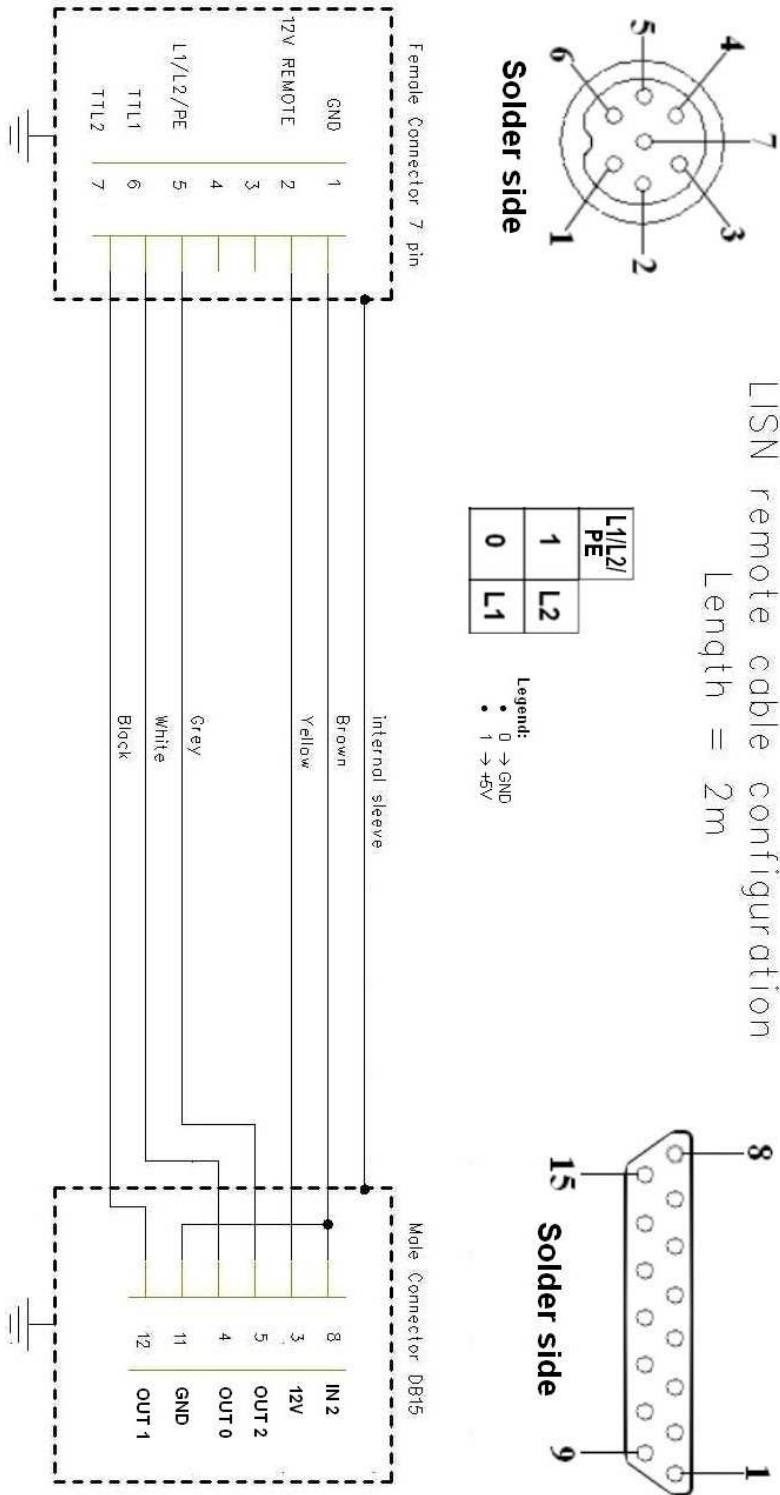

Fig. 2-4 PMM L2-16 remote cable configuration for PMM 9010

2.19 PMM L3-25 Remote Cable configuration for PMM 9010



The following figure shows the LISN remote cable pin configuration. The cable can be requested to Narda or arranged locally.

The PMM L2-16 is no longer supported. Please, check the manufacturing status of the Narda products from the website at <http://www.narda-sts.it> or contact your Narda – PMM local Dealer

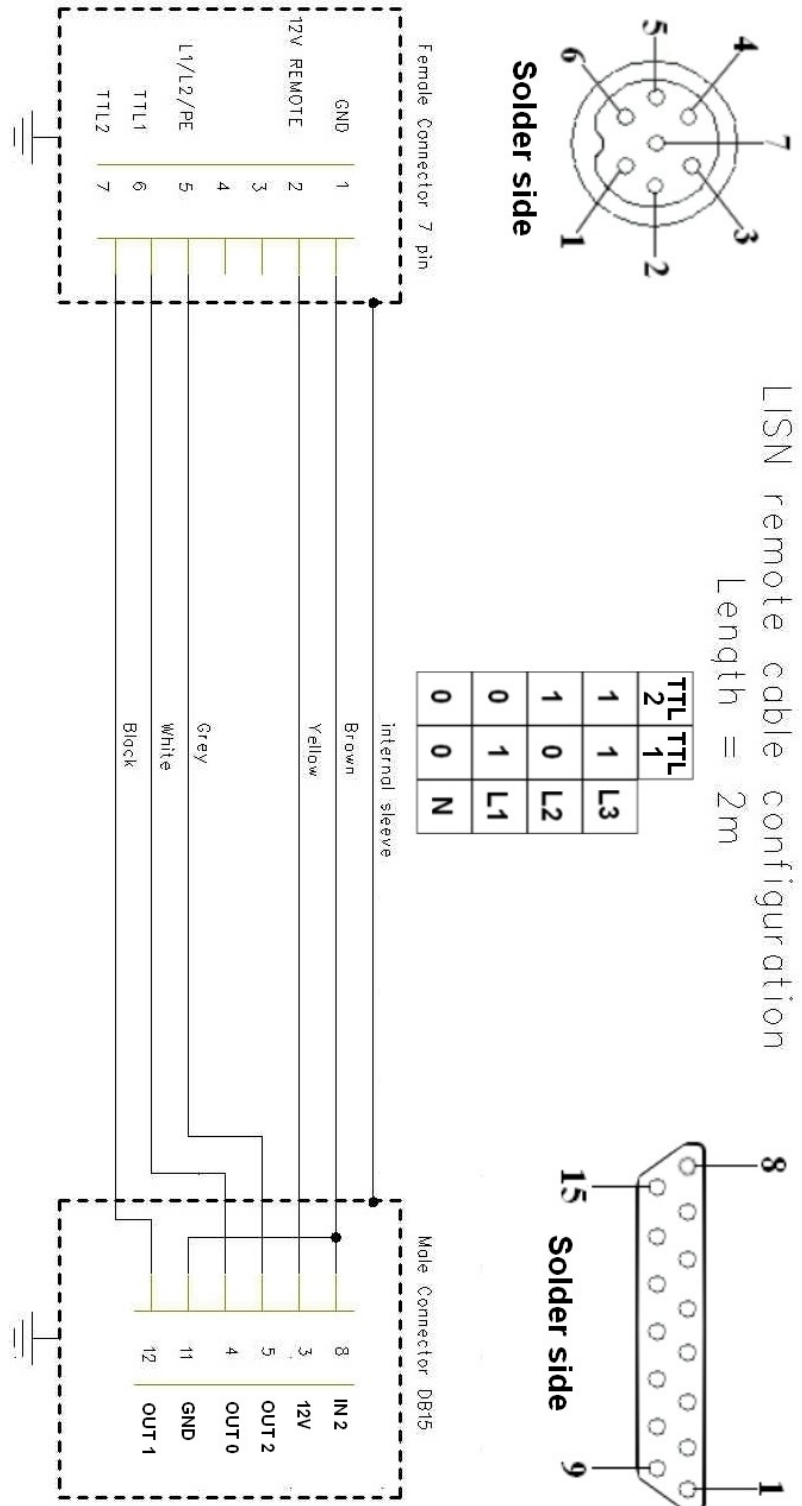
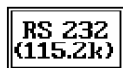
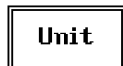

Fig. 2-5 PMM L3-25 remote cable configuration for PMM 9010

This page has been left blank intentionally

3 – Setup and Panel Instructions

3.1 Introduction



Press this function key in the main menu to enter in the **Setup** window, which allows the Operator to set the global parameters of the receiver, visualization options, etc.

The Setup function is divided into five, plus one, sub windows:

- Display
- Autocal
- Unit
- Rf Out
- Panel

Always use Esc button to return to the previous view/condition.

To scroll to the following page press the **Left** or **Right Arrow** key.

3.2 Display

The **Display** setup has four function keys:

- **Inverse**: to reverse the text and background colors;
- **Style**: to switch between font style 0 and font style 1;
- **Key border**: to choose the style of the key borderlines between three different possibilities;
- **Contrast / Back Light** (toggle switch): to adjust the backlight and contrast settings by the rotary knob.

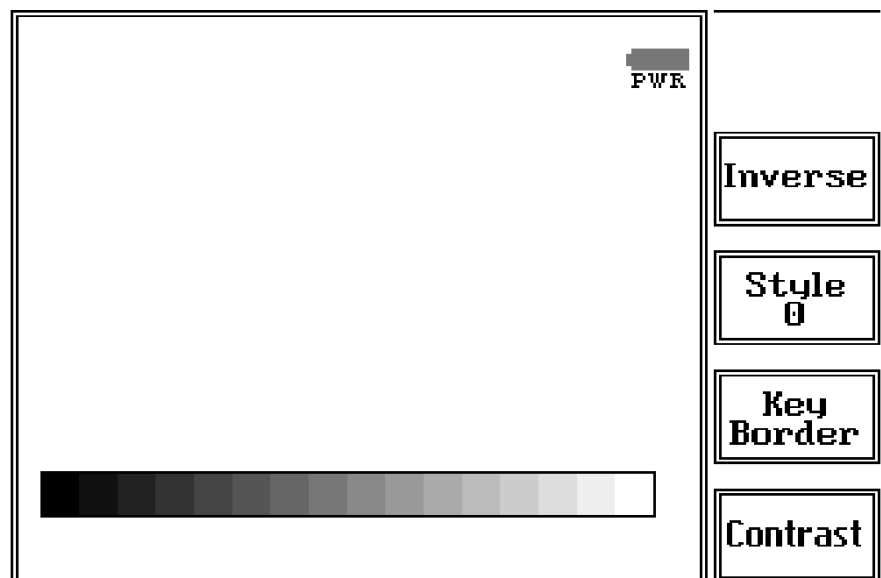
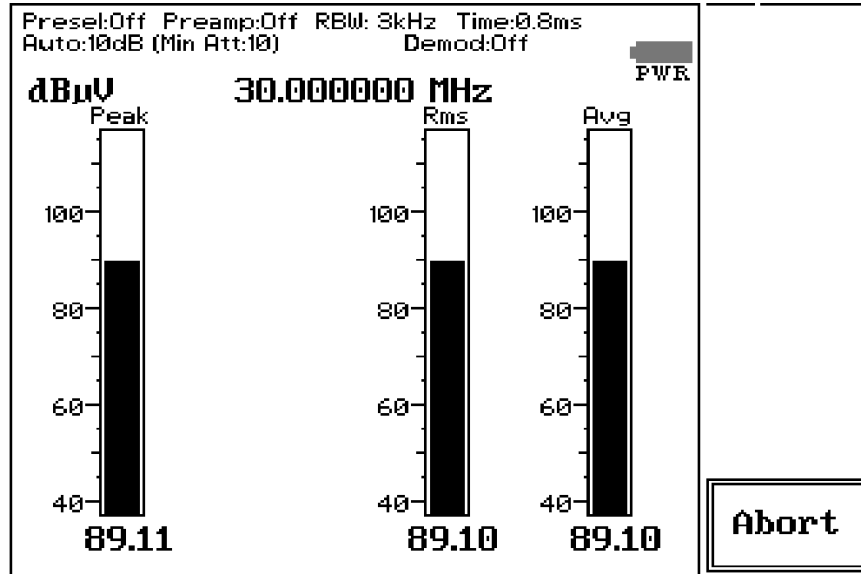

Fig. 3-1 Display setting

3.3 Autocal

Pressing the **Autocal** button PMM 9010 starts performing its automatic self-calibration, using the internal precise tracking generator as a reference. The connection between the internal tracking generator and the input of the receiver is done automatically inside the instrument.



To interrupt the self-calibration press the key **Abort**.

When the self-calibration is successfully finished a message is displayed:

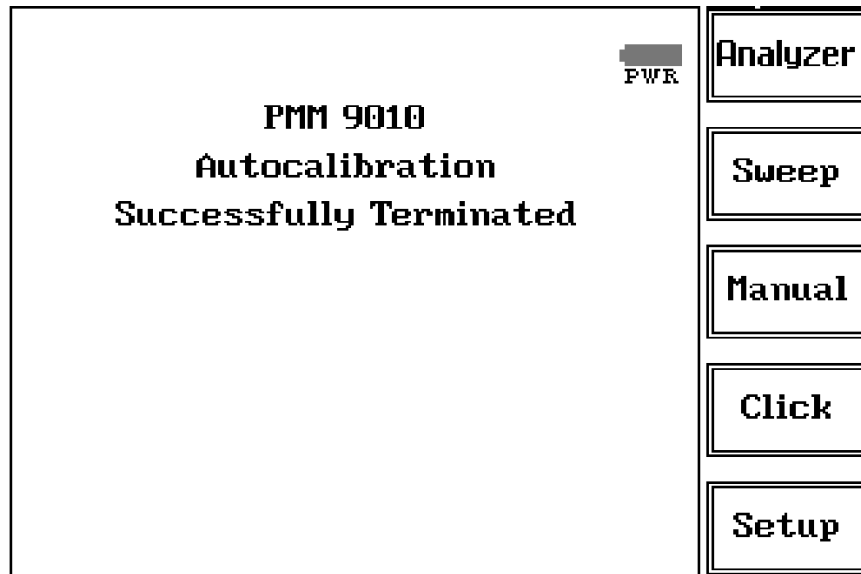

In order to avoid any possible external influence, it is suggested to disconnect all cables from the PMM 9010 RF ports during the self-calibration process.

It is strongly recommended that the User launches the self-calibration every now and then, and every time the instrument is used in temperature-limit conditions.





3.4 Unit



Entering in the **Unit** menu it is possible to change the indicated unit used to display the measured levels.

The available units are **dBμV** and **dBm**.

In a 50 Ohm system the relationship between dBm and dBμV is:

$$\text{dB}\mu\text{V} = \text{dBm} + 107$$

i.e., 0 dBm (1 mW) = 107 dBμV

3.5 RF OUT



The **tracking generator** is an internal, high stability and accuracy, 50 Ohm RF generator ranging from 10 Hz to 50 MHz.

Activating the **Tracking On** function the generator is always tuned at the same PMM 9010 measurement frequency and scans the range together with the receiver. This is the standard way a tracking generator works in all spectrum analyzers.

If the Tracking On function is disabled, the generator becomes a CW signal source tuned at the frequency set under the **RF OUT Freq** window.

As usual, to set a given frequency it is therefore enough to edit the value with the soft keys and the left and right arrows, confirming the selections entering the units value (kHz, MHz or GHz).

Pressing 0 as the first figure the decimal dot appears automatically.

In both operating modes (tracking or fixed frequency) the output level can be set between 60,0 and 90,0 dBμV with 0,1dB steps using the **RF OUT Level** button.

If a higher or lower level is needed, the User shall adopt either an external amplifier or an external attenuator.

The tracking generator is extremely useful for several applications: first of all it is essential to calibrate the receiver itself thanks to the automatic internal routines specifically developed to this extent, then it can also be used to transform the PMM 9010 in a scalar network analyzer, helping a lot in designing and testing RF filters, active stages and a lot of other circuits.

3.6 Panel



The Panel function allows the User to store up to 2 different setups that can be recalled any time.

Pressing **Save #1** or **Save #2** the actual setup is stored in the internal memory; with the two **Recall** buttons the corresponding setup is loaded to the receiver.

Please remember each time one of the Save buttons is pressed, the stored set-up is overwritten by the new one: the saved setups are therefore kept memorized in the receiver until a new set-up is stored in the same memory.

The **Default** button can be used to load a default standard setup saved into the memory at the factory.

3.7 RS 232 (Speed)

115200
BAUD

38400
BAUD

9600
BAUD

Pressing the **Left** or the **Right Arrow** key, inside the Setup menu, the second page appears. In the second page is the RS 232 Port speed setting function.

Here it is possible to set the bit rate of the RS 232 serial port which connector is located on the rear panel.

The actual setting is always shown between the parenthesis and it is possible to choose between 9600, 38400 and 115200 bps.

The default speed, that is the one to be used for standard communication, is **115200**.

In case an optional device (ex. GPIB interface) is to be connected to the RS 232 port, refer to its operating manual to know the correct speed to be selected.

4 - Sweep Mode Operating Instructions

4.1 Introduction

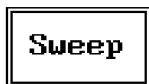

The **Sweep mode** is used to operate the PMM 9010 as a powerful scanning EMI receiver. To enter in this mode it's enough to depress the Sweep soft key on the main screen, and immediately the scan setup window pops up and allows the operator to set the parameters for the scan. All the automatic settings (RBW, frequency step, etc.) refer to the CISPR standard.

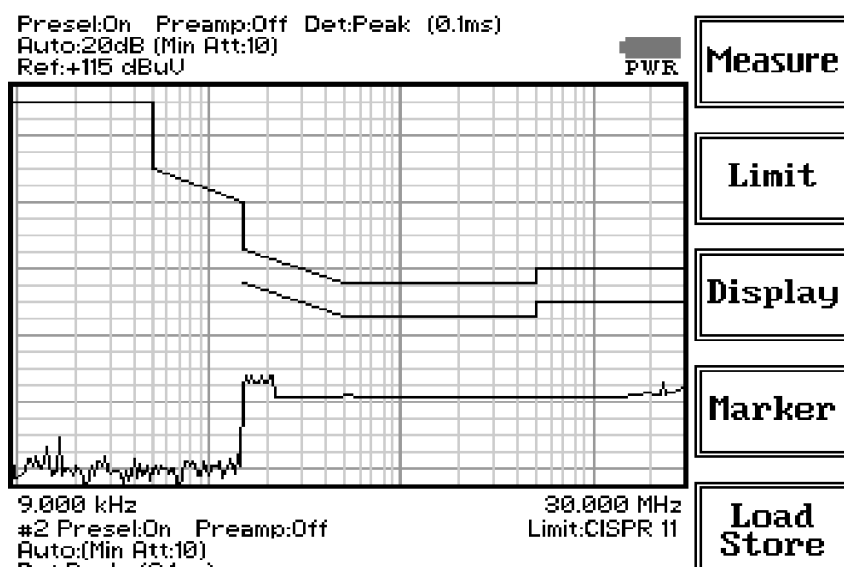

Fig. 4-1 Sweep

As for the Analyzer operating mode, all the relevant information are reported on the screen.

From the upper left corner, the User can see if the Preselector is ON or OFF; if the Preamplifier is ON or OFF; which detector is in use and the relevant hold time; if the function "Smart Detector" is activated and which one; if the input attenuation is Automatic or Manual and the set attenuation and if the Minimum attenuation is 10 dB or 0dB.

Just above the graph there is on the left the Reference level. During the scan, in the center above the graph the actual frequency measured and/or any other relevant operation (e.g. FFT, etc.).

Below the graph the start and the stop frequency, and loaded limits, if any.

When the sweep has been executed, on the bottom of the screen the most important sweep parameters are repeated.

If the graph has been loaded from the memory, just below the start frequency there is the symbol # followed by the memory position loaded (position number 2 in figure 4-1).

Please note that the information in the upper part above the graph refers to the next sweep to be done, while the information in the lower part, below the graph, concerns to the actual displayed data.



Thanks to its digital architecture and to the clever design, the PMM 9010 receiver can make very fast measurements in the lower CISPR band using the 200 Hz filter, yet maintaining full compliance to the standards even in this very difficult condition.



The Sweep mode function is divided into five sub windows:

- Measure
- Limit
- Display
- Marker
- Load Store

Always use Esc button to return to the previous view/condition.

4.2 Measure

The **Measure** button is used to set the scan parameters and to run the sweep.



After having chosen the frequency band and set all the other parameters it is possible to run the measurement scan simply touching the **Exec Sweep** button.

To make subsequent sweeps with the same setting parameters, simply press **ReDo Sweep**. This key is particularly useful after having loaded a previously stored track (see 4.6), as with the Re Do Sweep the original settings are kept for the new measurement: it is extremely easy to make comparisons, for example, before and after a modification of the EUT.

Once the scan starts, it can be stopped at any time during the execution by the **Stop** function key that appears during the scan.

4.2.1 Frequency

The **Frequency** menu features five function buttons:



Pressing **A Band** the receiver will be set to scan the 9 - 150 kHz frequency band. The definition of band A is a given in CISPR.

Pressing **B Band** the receiver will be set to scan the 0,15 - 30 MHz frequency band. The definition of band B is a given in CISPR.

Pressing **A + B Band** the receiver will be set to scan the entire band from 9 kHz to 30 MHz.

Using these automatic band settings, the Frequency Step and Resolution Bandwidth are set automatically according to CISPR standard requirement.

The **Start** and **Stop** frequency buttons can be used to set any frequency interval for the measurement; to enter the frequency values press the corresponding function keys.

Pressing either one of these 2 keys the figures 0, 1, 2, 3, and 4 are selectable at first; with the right arrow key it is possible to select the figures from 5 to 9, and pressing again the right arrow key the units kHz, MHz and GHz becomes accessible, as well as the decimal dot and the Back Space. The left arrow key can be used as well to move back and forth from one screen to the other. Pressing 0 as the first figure the decimal dot appears automatically.

To set a given frequency it is therefore enough to edit the value with the soft keys and the left an right arrows, confirming the selections entering the units value (kHz, MHz or GHz).

The figures entered appear in a small window just below the graph and the default unit is MHz.



4.2.2 Level

The Level function has 5 sub-menus, each one with several options..



Pressing the **Display** button it is possible to set two parameters: the visualized **Dynamic** range (chosen between 80, 100 and 120dB) and the **Reference Level**, that can be increased or reduced by steps of 5dB within the range +80 dB μ V to 135 dB μ V (-25 to +30 dBm).

The **Input** button opens a submenu which is dedicated to the setting of the input attenuator and to switch on-off the built-in preamplifier.

The PMM 9010 receiver takes automatically into account the settings of all the **Input** parameters and always displays the correct value of the level. The User is not required to make any correction to the readings.

4.2.2.1 Input: Attenuators and preamplifier

Being entered in the Input submenu, to increase or decrease the attenuation at the input, press **Att +** or **Att -**, and for each touch the attenuation is increased or decreased of 5 dB (preset value). Depressing either one of these keys force the receiver in manual attenuation.

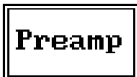

When the input attenuation is 0dB (condition that can be achieved only if the Minimum Attenuation is set to 0 dB as well), the yellow led to the left of the input BNC connector is ON and indicates a warning status.

The **Min Att** button acts as a toggle switch: it selects or deselects the minimum attenuation of 10 dB. When the minimum attenuation is selected, the attenuator – doesn't matter if in automatic or in manual condition - cannot be lowered under 10 dB.

Unless specifically required by the test conditions, do not remove the minimum attenuation of 10 dB.

With the **Preamp** key it is possible to insert or exclude the built-in low noise preamplification of 20 dB.

The internal 20 dB preamplifier can be used when very weak signals have to be investigated. As already mentioned, with the preamplifier ON the receiver takes automatically care of the 20 dB gain when measuring the signals.

The **Att Auto** button is used to switch from the two conditions of manual or automatic attenuation setting.

Please note that the switching of the attenuators is relatively noisy and you can perceive it distinctly with a "click" for each switch operation.



In case an OVERLOAD indication occurs it is necessary to add an external attenuator to carry on the measurement without overpassing the declared limit for continuous power or spectral density.

Using 0 dB attenuation PMM 9010 has no input protection. This is a potentially dangerous condition for the input stage of the receiver.



Use 0 dB attenuation only if you are very sure that your input signal is less than 0.5 Vpp (or 106 dB μ V).

Before to apply an unknown signal to PMM 9010 receiver, use an oscilloscope or a wide band RF voltmeter to measure it. In any case set Min. ATT at 10 dB and select the maximum available attenuation with preamplifier OFF.

If needed, add an external coaxial attenuator on the input signal line.

4.2.2.2 Misc



Under the **Miscellanea** functions menu it is possible to activate or exclude the **Preselector** filters, the **Pulse Limiter**, and also to enter in the **Tracking generator** menu pressing the **RF OUT** button.

The **Preselector** is composed by a group of filters automatically selected by the PMM 9010 while it is sweeping or anyway measuring. The aim of the preselector is to reduce the amount of out-of-band energy entering in the receiver, thus helping a lot in reducing intermodulation problems and similar undesired behaviors.

It can be set either ON or OFF with the associated button, and normally it should be always enabled.

On the top left corner of the screen the symbol "Off" or "On" will be displayed.

The **Pulse Limiter** is a very useful device to protect the input of the receiver from transient overvoltages. Doing conducted emission tests, quite often there are conducted disturbances (usually associated to switching operations in the EUT or along the line under test) which are too high and that propagates through the LISN up to the receiver. Sometime these disturbances cannot be seen on the receiver because they are out of measurement bandwidth, nevertheless the associate energy is high enough to damage the input attenuator and/or the Analog-to-Digital Converter of the PMM 9010 (the first mixer in a traditional receiver).

This pulse limiter has an integrated 10dB attenuator and a 30 MHz low-pass filter.

When the Pulse Limiter is selected, on the upper part of the screen the letters **P.L.** appear next the value of the Minimum Attenuation and the reading on the receiver is automatically corrected for the attenuation factor of the Pulse Limiter.

Pressing the **RF OUT** button the receiver enters the Tracking generator menu.

4.2.2.2.1 Tracking generator

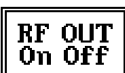

The **tracking generator** is an internal, high stability and accuracy, 50 Ohm RF generator ranging from 10 Hz to 50 MHz.

Activating the **Tracking On** function the generator is always tuned at the same PMM 9010 measurement frequency and scans the range together with the receiver. This is the standard way a tracking generator works in all spectrum analyzers.

If the Tracking On function is disabled, the generator becomes a CW signal source tuned at the frequency set under the **RF OUT Freq** window.

As usual, to set a given frequency it is therefore enough to edit the value with the soft keys and the left an right arrows, confirming the selections entering the units value (kHz, MHz or GHz).

Pressing 0 as the first figure the decimal dot appears automatically.

In both operating modes (tracking or fixed frequency) the output level can be set between 60,0 and 90,0 dBµV with 0,1dB steps using the **RF OUT Level** button.

If a higher or lower level is needed, the User shall adopt either an external amplifier or an external attenuator.

The tracking generator is extremely useful for several applications: first of all it is essential to calibrate the receiver itself thanks to the automatic internal routines specifically developed to this extent, then it can also be used to transform the PMM 9010 in a scalar network analyzer, helping a lot in designing and testing RF filters, active stages and a lot of other circuits.



It is suggested to turn off the Generator to achieve the maximum sensitivity.



4.2.2.2 Detector

Peak

Avg

RMS

QPeak

Hold Time

This menu allows the operator to select the most appropriate **detector** for the test.

In Sweep mode the Peak, Average, RMS (Root Mean Square) and Quasi-Peak detectors are available and can be selected via the appropriate button.

Hold time (ms)

The Hold Time (expressed in milliseconds) represents the time the receiver uses to “take a snapshot” of the incoming signal and to measure it with the chosen detector. When selecting a detector, the default hold time value is automatically loaded, but in some cases this time is not appropriate, e.g. when the interference signals have a low repetition rate. In this case the PMM 9010 sees a high input signal and therefore tries to set the proper attenuation automatically increasing the value or the input attenuators. However, when the input attenuation is set the signal is gone, so the receiver lowers the attenuation, but then a new peak arrives, and so on and so forth.

On the other hand, if the Hold Time is too high the PMM 9010 cannot properly follow the signals.

In this situation the **Hold Time** value should be manually set to find a correct compromise.

To set the **Hold Time** to the lowest possible value (this value dynamically depends from the measurement conditions), enter the figure 0; if a value lower than the allowed is entered, the lowest possible value is automatically selected.

The max. **Hold Time** that can be set is 30 sec (30.000 ms).

4.2.2.3 Smart Detector

Margin

Smart Avg

Smart RMS

Smart QPeak

Hold Time

The **Smart Detector** is an innovative special function implemented in the PMM 9010 receiver with the purpose of reducing the test time and increasing the productivity of the lab.

This function works only when at least one limit is loaded, therefore remember to enable a limit to run the Smart detector function.

Selecting one out of the three **Smart detectors** the receiver will execute the scan using at first the Peak detector and, if a peak value is found over the selected limit minus a **Margin** set with the specific button, the reading is re-measured and displayed with the chosen (AVG, RMS or QPeak) detector.

Obviously this way of operation results in a much faster scan sweep and moreover it immediately draws the attention of the test Engineer to the most critical points. The limit associated to the Margin is displayed as a bold black line and is automatically selected by the receiver depending which Smart detector is chosen; for example, if a Smart QP is selected, the associated QP limit line will be displayed as a bold black line.

The **Smart RMS** detector is disabled until a reference limit is defined by CISPR.

It is immediately clear that this function is very useful to dramatically reduce test time and increase the productivity of the test lab.

To deselect the Smart Detector function simply select a single detector.

The weighting time must be properly set in the Hold Time window to allow the Smart detectors functions to operate as intended.



4.2.3 Conversion factor



When using a transducer to make a measurement – a Voltage or Current Probe, an Antenna, etc. – there is always the need to add to the measured values the conversion factor of the transducer in use.

The Conversion factor may also take proper account of losses as cable loss, attenuators added externally to the receiver, etc.

The PMM 9010 can handle these factors in an automatic way and directly correct the readings.

The PMM 9010 can store in its internal non-volatile memory up to 4 different correction factors, and use them one at a time when recalled.

However, the **Conversion Factors** shall be created and loaded via the PMM 9010 Software Utility.

Press the relevant button to load the conversion factor, and **NONE** to unload it.

4.3 Limit



Each emission standard has one or more limits the User shall comply with. The PMM 9010 receiver has the possibility to load and activate one limit with a simple push of a button.

The preloaded standard limits refer to the most popular EMC emission standards: CISPR22, CISPR14 and CISPR11.

Other limits – or any custom designed limit – can be created, managed, selected and loaded through the PMM 9010 Software Utility running on a PC (and the test, of course, shall be handled via the PC software).

These additional custom limits cannot be stored in the memory of the PMM 9010, but only in the one of the PC where the 9010SW Utility is running.

The limits are shown on the scan display and they appear like a thin black line when the Smart Detector function is not enabled, while one of them appears in bold black when the Smart Detector function is active.

By pressing the NONE button all limits are deactivated.

4.4 Display

Pressing the **Display** button it is possible to set two parameters: the visualized **Dynamic** range (chosen between 80, 100 and 120dB) and the **Reference Level**, that can be increased or reduced by steps of 5dB within the range +80 dB μ V to 135 dB μ V (-25 to +30 dBm); see also 4.2.



4.5 Marker

Marker
OFF

Peak

Highest
7

Analyzer

Tune

Selecting this function a **Marker** is immediately enabled, and it appears on the screen as a small black pointing down arrow corresponding to the highest reading; simultaneously a small window shows up in the bottom left corner of the screen, indicating the actual frequency and level read by the marker.

The Marker function is not a simple search for the highest readings on the screen – it would be a useless exercise that would display a number of points all grouped together – but it's a true peak search that measures the degree of variation of the signal: a peak is so classified only if it “pops-up” from the adjacent signals with at least 5 dB difference in amplitude.

Following this criterion, if the measured signal is a flat line no peaks will be found.

Selecting **Highest X** – where X represents the maximum number of markers found by the receiver during its sweep – few more markers are added, each one “diamond” shaped, defined as per the previous explanation.

The maximum number of markers available is 10.

By using arrow keys it is possible to quickly move on markers from higher amplitude (left arrow) to lower amplitude (right arrow), i.e. if the highest is selected, pressing the right arrow key the 2nd highest is selected, then pressing again the same key the 3rd highest and so on and so forth.

It is also possible to use the rotary knob to move from a marker to the next one.

The marker under analysis (main marker) is a black arrow pointing down, the others are diamond shaped.

Pressing the **Peak** button the marker returns to the highest reading.

In order to make easier and faster the evaluation of the more noisy signals, the User can now select either the **Analyzer** or the **Tune** function, entering respectively into a spectrum analysis of main marker position or in the manual mode evaluation of it. To operate this two conditions please refer to the appropriate section of this Operating Manual.

In manual mode, i.e. having selected **Tune** on the main marker, it is possible to navigate from one peak to the other just pressing the arrow keys, without to come back to the Sweep display and remaining in manual mode.

This is another unique feature of PMM 9010 to improve the productivity of the test lab and make easier the work of the test engineer.

The **Marker Off** exits from the marker function.

4.6 Load Store



Pressing this key allows the User to have access to the memory of the receiver and enables the storing up to a number of different configurations/sweeps that depends on the parameters set on the receiver (i.e. the number of measured points). For example, using standard CISPR parameters it is possible to store up to 15 sweeps on the A+B band. Each new scan will be stored in the first available memory position thanks to the button **Store #x**, where x is the first available position. When all positions are occupied by a scan, this function is disabled until one of the previous scan is erased.

To load a stored trace, press the **Load #x** button until the proper scan is displayed; to unload a trace select the **Unload Trace** button.

Please note that the Load function is scanning the memory in a circular way, therefore all the occupied memory positions are shown in sequence. When the key shows "Load #4", it means the trace #3 is displayed and that the #4 will be loaded after the key is pressed, and so on and so forth.

To erase a trace, press the **Erase#x** button.

Due to the structure of the memory, it is possible to erase only the latest stored memory, with a sequence "LIFO" (Last In First Out), therefore after having erased the #x, the #(x-1) will be the trace to be erased. With reference to the example at the left, the last stored trace is the #4, and it is the first that will be erased. After that, the key will show "Erase #3", and so on and so forth.

A more advanced trace management could be done using the PMM 9010 Software Utility.



Turn Off the tracking generator, if it is not used, while you are in Scan Mode.

This prevents interferences and the measurements are more clean and accurate.

4.7 Ultra Fast FFT scan

The Ultra Fast FFT (Fast Fourier Transform), as described at §1.11, provides a "snapshot" of the whole band in just one second, what is useful for a more comprehensive analysis in case the disturbance to be evaluated is somehow intermittent and with an irregular repetition rate.

To activate this feature few settings have to be manually performed at first, as per the following:

- Peak detector
- ≤ 50ms Hold Time
- Band A sweep.

Once all these conditions are satisfied, the Sweep is performed in really "one second", what is very useful to soon realize overall behaviour of EUTs in a debugging phase, saving time and making it possible even in those cases where the EUT cannot stay ON for a long time without getting damaged (small electric motors, etc.)

Later on will be then possible to make the full-compliant Quasi-Peak evaluation of all the frequencies of interest after the measurements will be taken.

During such FFT analysis the PMM 9010 makes use of internal standard Gaussian filters still in compliance with the norms.



When using the Smart Detector under ultra fast FFT scan, the maximum number of investigated frequencies is 20.

5 - Analyzer Mode Operating Instructions

5.1 Introduction



To enter in the **ANALYZER Mode** it's enough to depress the Analyzer soft key on the main screen.

In this mode the receiver works as a powerful Spectrum Analyzer and the display shows the "spectrum analysis" (span max 30 MHz) in the frequency domain of a signal tuned at a given frequency.

The analysis is done at the selected span frequency.

Using the marker facility the User can accomplish a very accurate measurement of the signals either in frequency as well as in level.

Entering **Analyzer Mode** from the main menu, the display will look like the following:

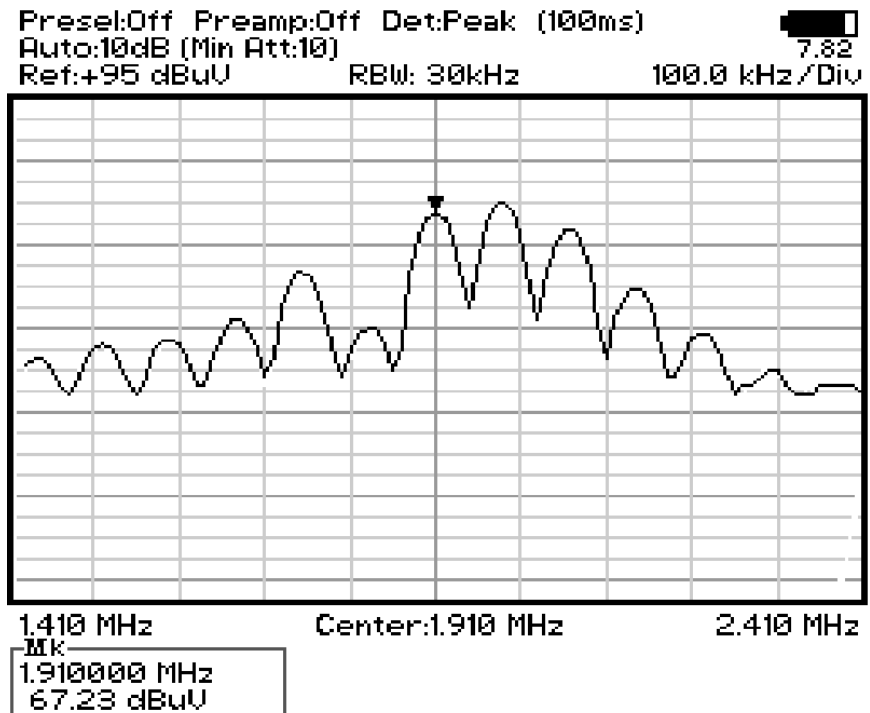

Fig. 5-1 Spectrum



The SPAN per division is automatically managed by the equipment and divided by 10. The minimum SPAN is 100Hz per division.

On the screen of the Analyzer Mode all the relevant information are reported. From the upper left corner, the User can see if the Preselector is ON or OFF; if the Preamplifier is ON or OFF; which detector is in use and the relevant hold time; if the input attenuation is Automatic or Manual and the set attenuation and if the Minimum attenuation is 10 dB or 0dB.

Just above the graph, from left to right, there is the Reference level, the Resolution bandwidth and the span value.

Below the graph the start, center and stop frequency.

The bottom left corner is dedicated to the marker indication, with actual frequency and level of the marker.



The Spectrum mode function is divided into five sub windows:

- Frequency
- Resolution Bandwidth
- Level
- Marker
- Wide Mode

The fifth button is used to change the spectrum view to **wide screen mode**, as shown in the picture 5-1, and with the **Esc** button the original view can be restored.

Always use **Esc** button to return to the previous view/condition.

5.2 Frequency

Allows the User to set the tuning frequency and also the Span.



The **Center** frequency of the Spectrum window can be directly edited into the window or set by the arrow buttons or by the rotary knob, which frequency steps are set under the Manual mode.

Depressing the **Center** button the figures 0, 1, 2, 3, and 4 are selectable; with the right arrow key it is possible to select the figures from 5 to 9, and pressing again the right arrow key the units kHz, MHz and GHz becomes accessible, as well as the decimal dot and the Back Space. The left arrow key can be used as well to move back and forth from one screen to the other. Pressing 0 as the first figure the decimal dot appears automatically.

To set a given frequency it is therefore enough to edit the value with the soft keys and the left an right arrows, confirming the selections entering the units value (kHz, MHz or GHz).

The figures entered appear in a small window just below the graph and the default unit is MHz, so 100 kHz = 0,1 MHz; 10 kHz = 0,01 MHz; 1 kHz = 0,001 MHz and 100 Hz = 0,0001 MHz.

Using the **Start** and **Stop** buttons it is possible to select any start and stop value in the frequency range 10 Hz to 30 MHz band.

Another method for setting the frequency is to enter the **Center** frequency and the appropriate **Span**.

In this mode of operation the frequency step (spectrum resolution) is set automatically, therefore it cannot be changed manually.

In order to better analyze the signals close to the ends of the band and see them properly with any of the applicable filters, the receiver is able to go lower than 10 Hz and higher than 30 MHz.

The actual minimum frequency that can be displayed on the screen is 0 Hz, the maximum is 32 MHz.



5.3 RBW

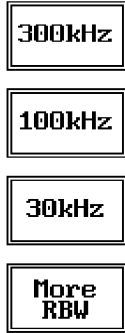

The **Resolution Bandwidth** command is used to select the bandwidth of the measuring filter. Seven bandwidth filters are available:

- 200 Hz CISPR 16 shaped at -6dB
- 9 kHz CISPR 16 shaped at -6dB
- 3 kHz at -3dB
- 10 kHz at -3dB
- 30 kHz at -3dB
- 100 kHz at -3dB
- 300 kHz at -3dB

The three larger filters are selectable from the first RBW screen, and pressing the **More RBW** button it is possible to select all the other filters.

These filters are mathematically modeled using FIR (Finite Impulse Response) technique and they are exactly as required by the standards.

More filters will be available as an option for specific applications, e.g. to cover Military Standards requirements, etc.

5.4 Level



The Level function has 5 sub-menus, each one with several options.

Pressing the Display button it is possible to set two parameters: the visualized Dynamic range (chosen between 80, 100 and 120dB) and the Reference Level, that can be increased or reduced by steps of 5dB within the range +60 dB μ V to 130 dB μ V (-45 to 25 dBm); in operating modes Analyzer and Manual the min.-max. values of the reference level are in function of the input attenuator and preamplifier settings.

The Input button opens a submenu which is dedicated to the setting of the input attenuator and to switch on-off the built-in preamplifier.

The PMM 9010 receiver takes automatically into account the settings of all the Input parameters and always displays the correct value of the level. The User is not required to make any correction to the readings.

5.4.1 Input: Attenuators and preamplifier



Being entered in the Input submenu, to increase or decrease the attenuation at the input, press **Att +** or **Att -**, and for each touch the attenuation is increased or decreased of 5 dB (preset value). Depressing either one of these keys force the receiver in manual attenuation.

When the input attenuation is 0dB (condition that can be achieved only if the Minimum Attenuation is set to 0 dB as well), the yellow led to the left of the input BNC connector is ON and indicates a warning status.

The **Min Att** button acts as a toggle switch: it selects or deselects the minimum attenuation of 10 dB. When the minimum attenuation is selected, the attenuator – doesn't matter if in automatic or in manual condition - cannot be lowered under 10 dB.

Unless specifically required by the test conditions, do not remove the minimum attenuation of 10 dB.

With the **Preamp** key it is possible to insert or exclude the built-in low noise preamplification of 20 dB.

The internal 20 dB preamplifier can be used when very weak signals have to be investigated. As already mentioned, with the preamplifier ON the receiver takes automatically care of the 20 dB gain when measuring the signals.

The **Att Auto** button is used to switch from the two conditions of manual or automatic attenuation setting.

Please note that the switching of the attenuators is relatively noisy and you can perceive it distinctly with a "click" for each switch operation.

Using 0 dB attenuation PMM 9010 has no input protection. This is a potentially dangerous condition for the input stage of the receiver.



Use 0 dB attenuation only if you are very sure that your input signal is less than 0.5 Vpp (or 106 dBμV).

Before to apply an unknown signal to PMM 9010 receiver, use an oscilloscope or a wide band RF voltmeter to measure it. In any case set Min. ATT at 10 dB and select the maximum available attenuation with preamplifier OFF.

If needed, add an external coaxial attenuator on the input signal line.

5.4.2 OVER RANGE Message

An Over Range indication will automatically appear on the screen to inform the User that the levels of the measured signals in the spectrum window is too high: to avoid measuring errors and even damages to the receiver a higher attenuation shall be set.

5.4.3 Misc



Under the **Miscellanea** functions menu it is possible to activate or exclude the **Preselector** filters, the **Pulse Limiter**, and also to set the **Tracking Generator**.

The **Preselector** is composed by a group of filters automatically selected by the PMM 9010 while it is sweeping or anyway measuring. The aim of the preselector is to reduce the amount of out-of-band energy entering in the receiver, thus helping a lot in reducing intermodulation problems and similar undesired behaviors.

In Analyzer mode the preselector is available only if the entire span falls in one filter band (see the main specification in chapter 1 to verify the frequency bands). In this situation on the display it will be shown: Preselector ON. If the span is larger then one filter only, on the display the symbol *** will appear instead.

It can be set either ON or OFF with the associated button, and normally it should be always enabled.

On the top left corner of the screen the symbol "Off" or "On" will be displayed.

The **Pulse Limiter** is a very useful device to protect the input of the receiver from transient overvoltages. Doing conducted emission tests, quite often there are conducted disturbances (usually associated to switching operations in the EUT or along the line under test) which are too high and that propagates through the LISN up to the receiver. Sometime these disturbances cannot be seen on the receiver because they are out of measurement bandwidth, nevertheless the associate energy is high enough to damage the input attenuator and/or the Analog-to-Digital Converter of the PMM 9010 (the first mixer in a traditional receiver).

This pulse limiter has an integrated 10dB attenuator and a 30 MHz low-pass filter.

When the Pulse Limiter is selected, on the upper part of the screen the letters P.L. appear next the value of the Minimum Attenuation and the reading on the receiver is automatically corrected for the attenuation factor of the Pulse Limiter.

Pressing the **RF OUT** button the receiver enters the Tracking generator menu.

5.4.3.1 Tracking generator



5.4.4 Detector

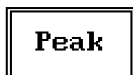

The **tracking generator** is an internal, high stability and accuracy, 50 Ohm RF generator ranging from 10 Hz to 50 MHz.

Activating the **Tracking On** function the generator is always tuned at the same PMM 9010 measurement frequency and scans the range together with the receiver. This is the standard way a tracking generator works in all spectrum analyzers.

If the Tracking On function is disabled, the generator becomes a CW signal source tuned at the frequency set under the **RF OUT Freq** window.

As usual, to set a given frequency it is therefore enough to edit the value with the soft keys and the left and right arrows, confirming the selections entering the units value (kHz, MHz or GHz).

Pressing 0 as the first figure the decimal dot appears automatically.

In both operating modes (tracking or fixed frequency) the output level can be set between 60,0 and 90,0 dB μ V with 0,1dB steps using the **RF OUT Level** button.

If a higher or lower level is needed, the User shall adopt either an external amplifier or an external attenuator.

The tracking generator is extremely useful for several applications: first of all it is essential to calibrate the receiver itself thanks to the automatic internal routines specifically developed to this extent, then it can also be used to transform the PMM 9010 in a scalar network analyzer, helping a lot in designing and testing RF filters, active stages and a lot of other circuits.

It is suggested to turn off the Generator to achieve the maximum sensitivity.

This menu allows the Operator to select the most appropriate detector for the test.

In Analyzer mode the Peak, Average and RMS (Root Mean Square) detectors are available and can be selected via the appropriate button.

Hold time

The Hold Time (expressed in milliseconds) represents the time the receiver uses to “take a snapshot” of the incoming signal and to measure it with the chosen detector. When selecting a detector, the default hold time value is automatically loaded, but in some cases this time is not appropriate, e.g. when the interference signals have a low repetition rate. In this case the PMM 9010 sees a high input signal and therefore tries to set the proper attenuation automatically increasing the value or the input attenuators. However, when the input attenuation is set the signal is gone, so the receiver lowers the attenuation, but then a new peak arrives, and so on and so forth..

On the other hand, if the Hold Time is too high the PMM 9010 cannot properly follow the signals.

In this situation the Hold Time value should be manually set to find a correct compromise.

To set the Hold Time to the lowest possible value (this value dynamically depends from the measurement conditions), enter the figure 0; if a value lower than the allowed is entered, the lowest possible value is automatically selected.

The max. Hold Time that can be set is 30 sec (30.000 ms).

5.4.5 Conversion factor



When using a transducer to make a measurement – a Voltage or Current Probe, an Antenna, etc. – there is always the need to add to the measured values the conversion factor of the transducer in use.

The Conversion factor may also take proper account of losses as cable loss, attenuators added externally to the receiver, etc.

The PMM 9010 can handle these factors in an automatic way and directly correct the readings.

The PMM 9010 can store in its internal non-volatile memory up to 4 different correction factors, and use them one at a time when recalled.

However, the **Conversion Factors** shall be created and loaded via the PMM 9010 Software Utility.

Press the relevant button to load the conversion factor, and **NONE** to unload it.

5.5 Marker



With this command the **Marker** function can be enabled.

Switching ON the marker it appears on the screen as a small black pointing down arrow, and simultaneously a small window shows up in the bottom left corner of the screen, indicating the actual frequency and level read by the marker.

Pressing the **Peak** button the marker will automatically move to the highest signal found in the span range in that given moment, and with the help of the **Center** button the frequency selected by the marker becomes the center frequency on the screen, making very easy any signal analysis.

5.6 ESC

This button allows to return to the previous view or condition.

6 - Manual Mode Operating Instructions

6.1 Introduction



The **MANUAL mode** is a very useful feature to manually control the receiver and to deeply investigate electrical signals modifying the parameters of receiver exactly as per the needs of the Test Engineer. It is possible, for example, to observe the signals exceeding the limits frequency by frequency; evaluating their levels measured simultaneously with 4 different detectors (Peak, QuasiPeak, Average and RMS); listening to them after a demodulation, etc.

To enter in **Manual Mode** press the key in the main menu, and immediately the first Manual window opens as follow.

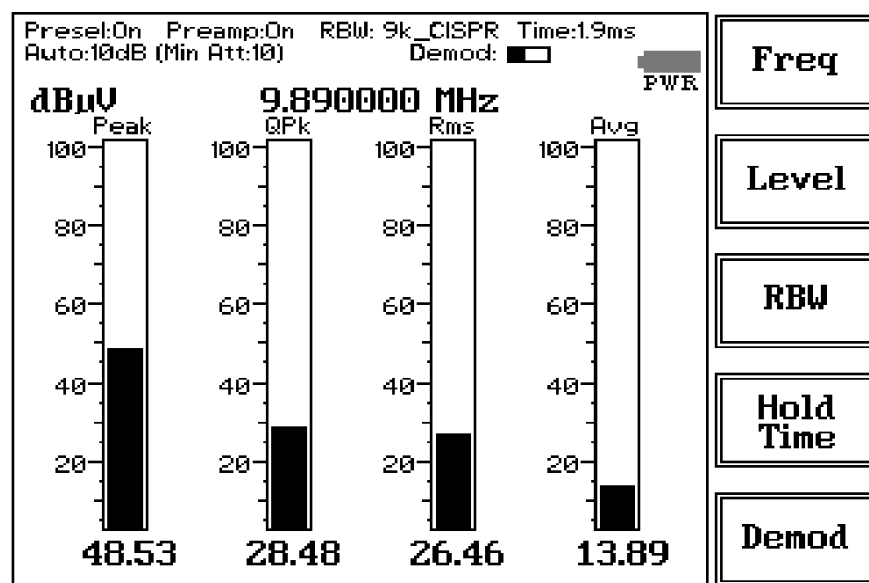

Fig. 6-1 Manual

In manual mode the levels corresponding to the detectors in use are displayed both in analogue and in digital format, and exactly as for the other operating modes, all the relevant information are reported on the screen. From the upper left corner, the User can see if the Preselector is ON or OFF; if the Preamplifier is ON or OFF; the resolution bandwidth, the longest hold time associated to the detectors in use; if the input attenuation is Automatic or Manual and the set attenuation and if the Minimum attenuation is 10 dB or 0dB; if there a demodulation and the level of the volume, represented by a small black bar. Then there are three or fours vertical bars representing the detectors and indicating in analogue and digital (the figures below each bar) the level measured; on top of the bars the relevant detector, the unit in use and the tuned frequency. The analogue scale of the analogue bars is set automatically by the receiver.



The Manual mode function has five sub windows:

- Frequency
- Level
- Resolution Bandwidth
- Hold Time
- Demodulation

Always use Esc button to return to the previous view/condition.

6.2 Frequency

Under this menu it is possible to set the tuning frequency and also the knob and the arrow keys steps.



The center Frequency of the reading can be directly edited into the **Tune** window or set by the left and right arrow buttons or by rotating the knob. The figures entered appear in a small window just below the graph and the default unit is MHz.

Having selected **Tune**, the figures 0, 1, 2, 3, and 4 are selectable at first; with the right arrow key it is possible to select the figures from 5 to 9, and pressing again the right arrow key the units kHz, MHz and GHz becomes accessible, as well as the decimal dot and the Back Space. The left arrow key can be used as well to move back and forth from one screen to the other. Pressing 0 as the first figure the decimal dot appears automatically. To set a given frequency it is therefore enough to edit the value with the soft keys and the left and right arrows, confirming the selections entering the units value (kHz, MHz or GHz).

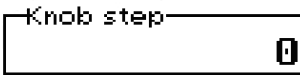

If **Knob** is selected, the small window below the bars indicate the step which is going to be selected. After having fixed the step size, rotate the know and tune the desired frequency.

If **Arrow** is selected, the small window below the bars indicate the step which is going to be selected. After having fixed the step size, press the left and the right arrow keys to decrease or increase the frequency by the selected step.

6.3 Level

The Level function has 4 sub-menus.



Pressing the **Display** button it is possible to set two parameters: the visualized **Dynamic** range (chosen between 80, 100 and 120dB) and the **Reference Level**, that can be increased or reduced by steps of 5dB within the range +60 dB μ V to 130 dB μ V (-45 to 25 dBm); in operating modes Analyzer and Manual the min.-max. values of the reference level are in function of the input attenuator and preamplifier settings.

The **Input** button opens a submenu which is dedicated to the setting of the input attenuator and to switch on-off the built-in preamplifier.

The PMM 9010 receiver takes automatically into account the settings of all the Input parameters and always displays the correct value of the level. The User is not required to make any correction to the readings.



6.3.1 Input: Attenuator and preamplifier



Being entered in the Input submenu, to increase or decrease the attenuation at the input, press **Att +** or **Att -**, and for each touch the attenuation is increased or decreased of 5 dB (preset value). Depressing either one of these keys force the receiver in manual attenuation.

When the input attenuation is 0dB (condition that can be achieved only if the Minimum Attenuation is set to 0 dB as well), the yellow led to the left of the input BNC connector is ON and indicates a warning status.

The **Min Att** button acts as a toggle switch: it selects or deselects the minimum attenuation of 10 dB. When the minimum attenuation is selected, the attenuator – doesn't matter if in automatic or in manual condition - cannot be lowered under 10 dB.

Unless specifically required by the test conditions, do not remove the minimum attenuation of 10 dB.

With the **Preamp** key it is possible to insert or exclude the built-in low noise preamplification of 20 dB.

The internal 20 dB preamplifier can be used when very weak signals have to be investigated. As already mentioned, with the preamplifier ON the receiver takes automatically care of the 20 dB gain when measuring the signals.

The **Att Auto** button is used to switch from the two conditions of manual or automatic attenuation setting.

Please note that the switching of the attenuators is relatively noisy and you can perceive it distinctly with a "click" for each switch operation.

Using 0 dB attenuation PMM 9010 has no input protection.

This is a potentially dangerous condition for the input stage of the receiver.

Use 0 dB attenuation only if you are very sure that your input signal is less than 1 V (or 120 dBμV).

Before to apply an unknown signal to PMM 9010 receiver, use an oscilloscope or a wide band RF voltmeter to measure it. In any case set Min. ATT at 10 dB and select the maximum available attenuation with preamplifier OFF.

If needed, add an external coaxial attenuator on the input signal line.



In case an OVERLOAD indication occurs it is necessary to add an external attenuator to carry on the measurement without overpassing the declared limit for continuous power or spectral density.

6.3.2 Misc



Under the **Miscellaneous** functions menu it is possible to activate or exclude the **Preselector** filters, the **Pulse Limiter**, and also to set the **Tracking generator**.

The **Preselector** is composed by a group of filters automatically selected by the PMM 9010 while it is sweeping or anyway measuring. The aim of the preselector is to reduce the amount of out-of-band energy entering in the receiver, thus helping a lot in reducing intermodulation problems and similar undesired behaviors.

It can be set either ON or OFF with the associated button, and normally it should be always enabled.

On the top left corner of the screen the symbol "Off" or "On" will be displayed.

The **Pulse Limiter** is a very useful device to protect the input of the receiver from transient overvoltages. During conducted emission tests, quite often there are conducted disturbances (usually associated to switching operations in the EUT or along the line under test) which are too high and that propagate through the LISN up to the receiver. Sometimes these disturbances cannot be seen on the receiver because they are out of measurement bandwidth, nevertheless the associated energy is high enough to damage the input attenuator and/or the Analog-to-Digital Converter of the PMM 9010 (the first mixer in a traditional receiver).

This pulse limiter has an integrated 10dB attenuator and a 30 MHz low-pass filter.

When the Pulse Limiter is selected, on the upper part of the screen the letters **P.L.** appear next to the value of the Minimum Attenuation and the reading on the receiver is automatically corrected for the attenuation factor of the Pulse Limiter.

Pressing the **RF OUT** button the receiver enters the **Tracking generator** menu.



The **tracking generator** is an internal, high stability and accuracy, 50 Ohm RF generator ranging from 10 Hz to 50 MHz.



Activating the **Tracking On** function the generator is always tuned at the same PMM 9010 measurement frequency and scans the range together with the receiver. This is the standard way a tracking generator works in all spectrum analyzers.



If the Tracking On function is disabled, the generator becomes a CW signal source tuned at the frequency set under the **RF OUT Freq** window.

As usual, to set a given frequency it is therefore enough to edit the value with the soft keys and the left and right arrows, confirming the selections entering the units value (kHz, MHz or GHz).

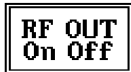

Pressing 0 as the first figure the decimal dot appears automatically.

In both operating modes (tracking or fixed frequency) the output level can be set between 60,0 and 90,0 dB μ V with 0,1dB steps using the **RF OUT Level** button.

If a higher or lower level is needed, the User shall adopt either an external amplifier or an external attenuator.

The tracking generator is extremely useful for several applications: first of all it is essential to calibrate the receiver itself thanks to the automatic internal routines specifically developed to this extent, then it can also be used to transform the PMM 9010 in a scalar network analyzer, helping a lot in designing and testing RF filters, active stages and a lot of other circuits.



It is suggested to turn off the Generator to achieve the maximum sensitivity.



6.4 RBW



The **Resolution Bandwidth** command is used to select the bandwidth of the measuring filter. Seven bandwidth filters are available:

- 200 Hz CISPR 16 shaped at -6dB
- 9 kHz CISPR 16 shaped at -6dB
- 3 kHz at -3dB
- 10 kHz at -3dB
- 30 kHz at -3dB
- 100 kHz at -3dB
- 300 kHz at -3dB

The three larger filters are selectable from the first RBW screen, and pressing the **More RBW** button it is possible to select all the other filters. These filters are mathematically modeled using FIR (Finite Impulse Response) technique and they are exactly as required by the standards. More filters will be available as an option for specific applications, e.g. to cover Military Standards requirements, etc.

With the **Auto Cispr** function, the filter will be automatically selected, according to CISPR standard, depending on the tuned frequency.

When a non-CISPR filter is selected, the Quasi Peak detector is disabled.

6.5 Hold Time

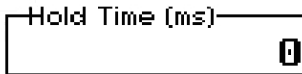

The Hold Time (expressed in milliseconds) represents the time the receiver uses to “take a snapshot” of the incoming signal and to measure it with the chosen detector. When selecting a detector, the default hold time value is automatically loaded, but in some cases this time is not appropriate, e.g. when the interference signals have a low repetition rate. In this case the PMM 9010 sees a high input signal and therefore tries to set the proper attenuation automatically increasing the value or the input attenuators. However, when the input attenuation is set the signal is gone, so the receiver lowers the attenuation, but then a new peak arrives, and so on and so forth..

On the other hand, if the Hold Time is too high the PMM 9010 cannot properly follow the signals.

In this situation the Hold Time value should be manually set to find a correct compromise.

To set the Hold Time to the lowest possible value (this value dynamically depends from the measurement conditions), enter the figure 0; if a value lower than the allowed is entered, the lowest possible value is automatically selected.

The max. Hold Time that can be set is 30 sec (30.000 ms).

6.6 Demodulator

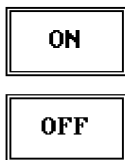

Switching ON the built-in AM demodulator, the volume can be adjusted with the rotating knob, and the level is shown by the black bar on the screen.

The demodulated signals can be heard with headphones or earphones connected to the front panel of the PMM 9010, or amplified and/or recorded by any suitable device.

An FM demodulator – or other demodulators - is not available for the time being in the frequency band covered by the PMM 9010.

Demod:



Insert the headphones jack connector only before switching on the Demodulator or when the receiver power is off.

This page has been left blank intentionally



7 – Applications

7.1 Measuring the EMI Voltage

ElectroMagnetic Interference (EMI) voltage measurements on power supply lines or on signal lines are carried out by means of "Coupling Networks" (e.g. LISNs) or other transducers (e.g. antennas, voltage probes). The frequency range is dictated by the applicable standard, however it is generally limited from 9 kHz to 30 MHz in commercial applications, while for measurements on other equipment/accessories - e.g. military, automotive, information technology and communication equipment (ITE), ISDN devices, etc. - the frequency range extends down to 20 Hz and up to 200 MHz, depending the relevant standards.

Nevertheless, the most common tests in the frequency range covered by PMM 9010 are certainly the conducted measurements done with the help of a LISN.

7.1.1 Measuring Principle with a LISN

In the case of a system with two floating conductors, the EMI voltages of the two conductors relative to each other and with reference to the ground form a vector system where three kind of RFI voltages are present (sometime EMI is also referred as RFI: Radio Frequency Interference). They are:

- Symmetrical (or differential mode) voltages. These RFI components are measured between the two conductors. They behave like the wanted signal on the forward and return lines.
- Asymmetrical (or common mode) voltages. These EMI components are measured between the electrical midpoint of the two conductor voltages and reference ground. Usually these are the components most likely to cause interference effects.
- Unsymmetrical voltages. These RFI components are measured from each line conductor and the reference ground. They consist of symmetrical and asymmetrical components. The measurement of these RFI voltages is the easiest to do and the most commonly performed.

Indeed, for practical reasons, Standards mostly specify the measurements of unsymmetrical voltages instead of the theoretically more meaningful common mode EMI, but the standard doesn't necessarily reflect the real life exactly as it is: it shall be a common practice reference aiming to create a database of fully comparable results.

See figure 7-1 for a graphic explanations of these differences between the EMI voltages.

Some Regulations require both measurement of symmetrical and asymmetrical RFI voltages, also defining separate and different limits for them.

7.1.2 Coupling Networks

Coupling Networks are electrical interfaces which allow to "transfer" the quantity to be measured (e.g. EMI voltages or currents) from the lines under test to the receiver.

Some types of Coupling Networks are: AMN (Artificial Mains Network), also known as "LISN" (Line Impedance Stabilization Network), Current Probe and Voltage Probe. Again, Fig. 7-1 also shows the AMN principle.

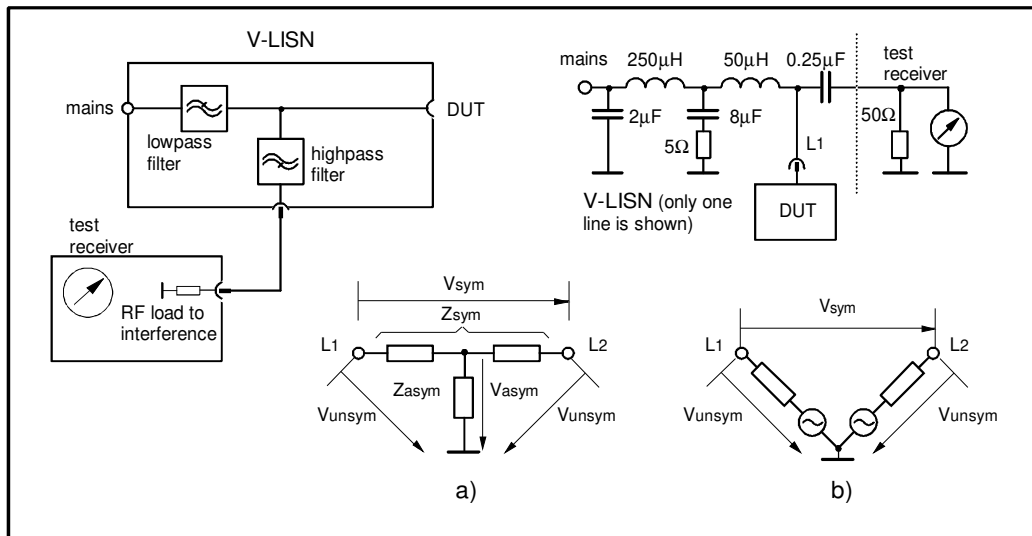

Fig. 7-1 AMN Principle: a) Δ -type or T-type LISN ; b) V-type LISN

7.1.2.1 AMN

AMNs are usually classified depending their configuration: V-type Networks, Δ -type Networks, T-type Networks.

- The V-type Network is used for measuring the unsymmetrical RFI voltage on AC and DC supply line. Standard impedances specified by CISPR and other international standards are $50\Omega // 50\mu\text{H} + 5\Omega$ and $50\Omega // 5\mu\text{H} + 1\Omega$.
- The Δ -type Network is used for measuring the symmetrical RFI voltage on balanced telecommunication lines. It is generally designed to permit switchover between symmetrical and asymmetrical RFI measurements. Its use is limited; Standards usually specify the T-type Network instead. The most common impedance for Δ -type Network is 150Ω .
- The T-type Network is used for measuring the asymmetrical RFI voltage on balanced (electrically symmetrical) audio frequency, control and data lines. Standard impedance is 150Ω as well.

An Artificial Mains Network shall be designed in order to:

1. terminate each line (power, signal, etc.) of the EUT (Equipment Under Test) with a standardized impedance;
2. permit the feeding of the EUT with the proper supply voltage and current or with the signal and data required for operations;
3. isolate the side of the test circuit where EMI voltages are measured against interference coming from mains network or from the auxiliary equipment supplying the EUT with the required data;
4. provide a suitable test point – to be connected to the test receiver - to pick up the RFI voltages from the conductor under test;
5. ensure that the impedance of the source (power, signal) is not varied in a significant way, otherwise EUT response to the interference may change.

7.1.2.2 Current Probe

Current Probes may be Clamp-on Probes or Fixed-ring Probes. Current Probes are used to measure differential or common mode RFI currents. In some cases it may be important to make a distinction between the two kinds of current flowing in a system.

RFI current measurements with Current Probes may be required, for example, when measuring EMI from shielded lines or from complex wiring systems, when finding interference sources among other sources in a system, when performing compliance to some Standards, etc.

7.1.2.3 Voltage Probe

Voltage Probes include Active Probes and Passive Probes. Active Probe has a very high input impedance $Z_{in} > 100\text{ K}\Omega // < 10\text{ pF}$. Passive Probe has a standard impedance $Z_{in} = 1,5\text{ K}\Omega // < 10\text{ pF}$.

Voltage Probe is used for measuring the unsymmetrical RFI voltage when it is not possible to carry out measurement by interconnecting an Artificial V-type Network. Such situation may occur, for example, when measuring on lines on which only small loads are permissible (control and signal lines), when measuring on a EUT (Equipment Under Test) which would not operate correctly using V-type LISN or a DUT (Device Under Test) requiring very high power supply current for which no V-type LISN is available.

For diagnostic or design purposes on high impedance circuits, Voltage Probe may be used to determine, for example, noisy components or conductors that cause interference on CMOS PC boards. Some Regulations give statements when Voltage Probe are to be used and specify relevant setup and RFI voltage limits.

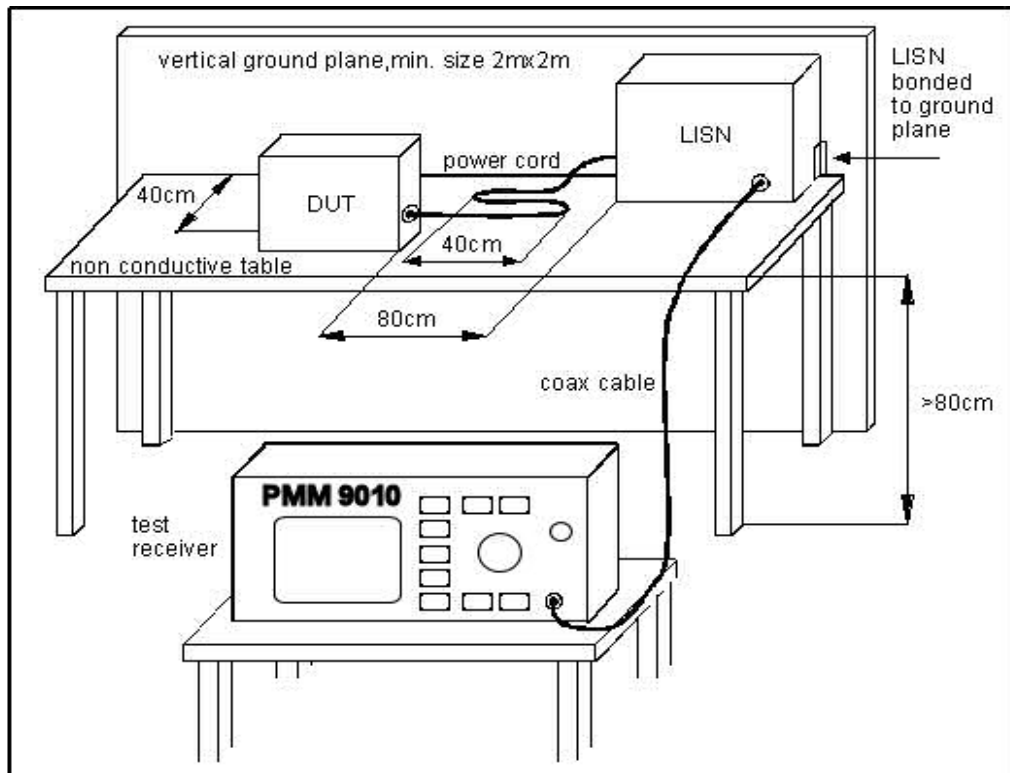

Fig. 7-2 Example of Test Setup for RFI Voltage Measurement

7.1.3 Test Setup

Fig. 7-2. shows an example of test setup for RFI voltage measurement. The DUT is placed 0,4 m from an horizontal or vertical earthed conducting surface of at least 2 m x 2 m in size.

A table top DUT is placed 0,8 m from the LISN and at least 0,8 m from any other earthed conducting surface. If the measurements are made in a shielded room, the DUT shall be placed 0,4 m from one of the walls of the room.

The LISN shall be bonded to the reference conducting surface.

A Floor standing DUT is placed 0,1 m above an horizontal earthed conducting surface of at least 2 m x 2 m in size. This size shall be exceeding by at least 0,5 m the projection of the DUT on the conducting surface. The power cable should be 1m long; longer cable should be centrally bundled for at least 40 cm.

DUTs without a PE (Protective Earth) conductor and manually operated DUTs shall be measured in conjunction with an auxiliary screen or an "Artificial Hand", as duly specified in the relevant standards.

All the details and information on the test setup are written on the latest version of the applicable Standard.

7.1.4 Guidance on a preliminary Measuring Procedure

A step-by-step example of a conducted test manually performed is the following:

1. Switch ON the PMM 9010 and enter in **Sweep** Mode pressing the relevant button;
2. Select **Display** and then **120dB**; Reference Level should be between 110 and 135 dB μ V; press **Esc**;
3. Touch the **Measure** key, then **Freq** and **A+B Band**;
4. Then **Level, Input** and set the Minimum Attenuation to 10 dB and the Attenuation is automatic; press **Esc**;
5. Select **Misc, Presel** and **Pulse Limiter** to enable the preselction and the protection of the input from voltage spikes; press **Esc**;
6. Enter in the **Detector** menu and select **Peak**; press **Esc** two times;
7. Connect a LISN or any other suitable transducer to the RF input, selecting the proper phase/line whenever applicable;
8. With the EUT switched OFF touch **Exec Sweep** and wait until the first scan has been finished;
9. Carry out an overview of the whole spectrum and check the by executing a pre-measurement with peak detector that the ambient RF disturbances are at least 20 dB below the desired emission levels;
10. If the ambient noises are low enough continue to the next step, otherwise take all the necessary steps to reduce the ambient disturbances (e.g. go to a shielded room, etc.);
11. Switch ON the EUT and then **Measure, Exec Sweep** again and wait until the scan has been finished;
12. Enter in the **Display** menu and adjust the Dynamic Range and the Reference Level to the most convenient visualization;
13. If the results are satisfactory select **Marker, Peak** and then either **Analyzer** or **Tune** to enter respectively in Spectrum Mode or in Manual Mode and deeply investigate the highest signals;
14. If the results of the scan need to be refined, select a **Limit**, if appropriate, and then **Measure, Level** and **Smart Detector** (if a limit has been loaded);
15. In the **Smart Detector** menu check the best combination among those listed; enter a **Margin**, if needed; press **Esc**;
16. **Exec Sweep** again and repeat from step #12.

**7.1.5 Remarks and Hints
for Measuring**

To avoid errors caused by ambient interference, measurements should be carried out inside a properly shielded room. Different sites, like basements or other rooms with low ambient interferences, are often sufficient for a preliminary evaluation.

Conducted measurements do not strictly require any anechoic environment, while radiated tests may need it if so specified by the relevant standard.

Using the PMM 9010 SW Utility running on an external PC it is possible to make automatic measurements and to automatically select LISNs lines (with a PMM LISN), etc.

This page has been left blank intentionally

8 – Updating firmware and Activation code Utility

8.1 Introduction

The PMM 9010 features a simple and user-friendly method for updating its internal firmware through a Personal Computer (PC).

The “**WrDongle**” embedded in the FW Upgrade Tool is used for the **Options** activation procedure.

This section provides all the information required for easy updating.

8.2 System requirements

The minimum requirements to allow the software to operate properly are the following:

- 486 Processor or Pentium
- 16 Mb of RAM
- at least 10 Mb of free space on hard disk
- 1 free Serial Port (RS-232), or, alternatively, a USB/RS-232 Adapter with related driver
- Windows Operating System™ 95/98/2000/XP/Vista/Win7



To use the Update Firmware and WrDongle utility procedure, the baud rate of the RS232 port must be set to 115200.



The User must have administrator privileges to install the software in Windows 7; right click on the program .exe file and click on “Run as administrator” to temporarily run the program or application as an administrator until close it (Windows 7 also allows to mark an application so that it always runs with administrator rights).

8.3 Preparing the Hardware

Turn off the PMM 9010 and connect the RS-232 cable supplied with the apparatus directly or through a USB/RS-232 Adapter separately purchased (once related driver has been properly installed), to the 9 pin socket situated on the back panel of PMM 9010 on one side and to a free RS232 port (or USB in case of Adapter’s use) on the PC side.

The first free RS-232 port will be automatically detected by the Firmware Update Program during installation. In case of troubles please check port assignments on the PC through the Control Panel utility.

8.4 Software Installation

The Update Firmware and 9010 WrDongle executable programs are provided together with the 9010 Software Utility stored on Software Media and included in PMM 9010 Receiver package; anyway it’s always possible to check for newer releases and download them from official NARDA Italy Web Site Support page.

Once the **9010SeriesUp Setup** has been installed in the PC, another item is created in the Programs list at Start Menu, which is “**PMM Emission Suite**”, from where the “**9010SeriesUp**” and “**WrDongle**” programs can be easily run.

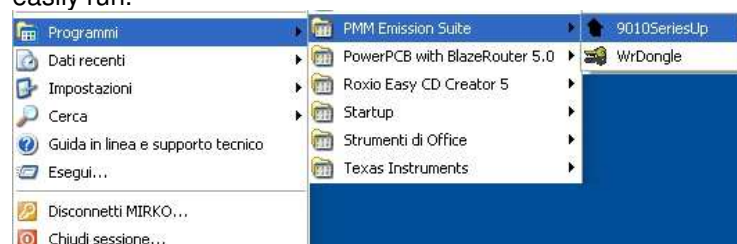

WARNING

Be sure the baud rate of the RS232 port is set to 115200.

Click on "9010SeriesUp" (9010SeriesUp.exe) once for running the update program, so getting the following window:



Two firmware components can be updated by this application: Firmware, which is the receiver internal program, and FPGA, to update the internal programmable logic.

The **9010FW.bin** file required for Firmware updating and the **PPI_ramp.bin** file for FPGA are automatically stored in the same directory of the **9010SeriesUp.exe**, otherwise just copy them there before performing the upgrade.

Be sure batteries of PMM 9010 and connected Laptop (PC) are fully charged before performing the FW Upgrade, otherwise the upgrade progress could not terminate properly.

Alternatively, be sure to have both PMM 9010 and Laptop (PC) powered through their respective AC/DC power adapters.

WARNING

Anyway, even in case of failure, the internal BIOS will never be corrupted and you'll just need to repeat the procedure once more (this is a unique feature!).

Should FW Upgrade procedure stop before reaching the 100% completion that will have not to be considered a trouble but simply an intermediate step: in this case please switch OFF and ON the receiver and repeat the FW Upgrade procedure once more until the end.

Always cycle power OFF and ON again after every FW Upgrade.

Choose the COM port pressing the **Up** or the **Down** arrows.

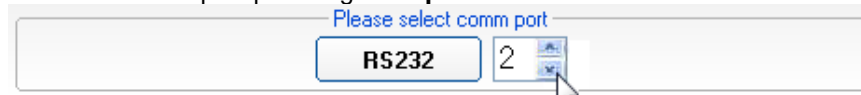

Move the cursor to the COM port number and select the left mouse button to highlight the box.

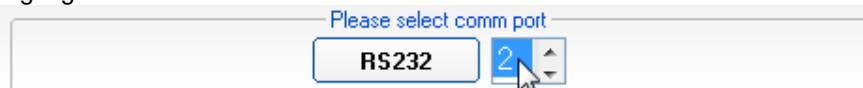

Press **RS232** button or **Enter** key to set the com port.

The program will display the following window:

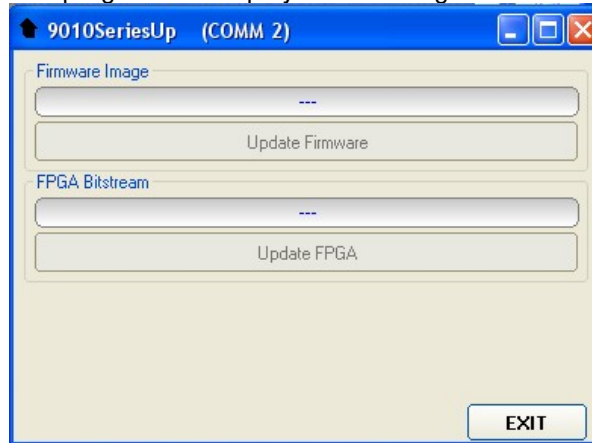

8.5 To transfer data

To start the process simply switch PMM 9010 on, select **Update Firmware** or **Update FPGA** button, and wait until the automatic transfer is completed.

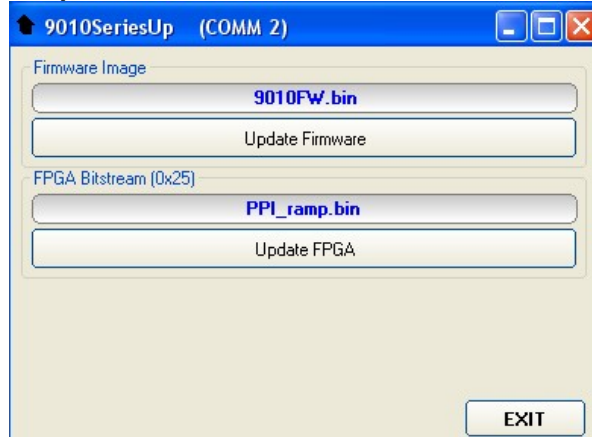

During the firmware storing procedure, a blue bar will progress from left to right in the window of the PC, showing percentage of downloading time by time until 100%.

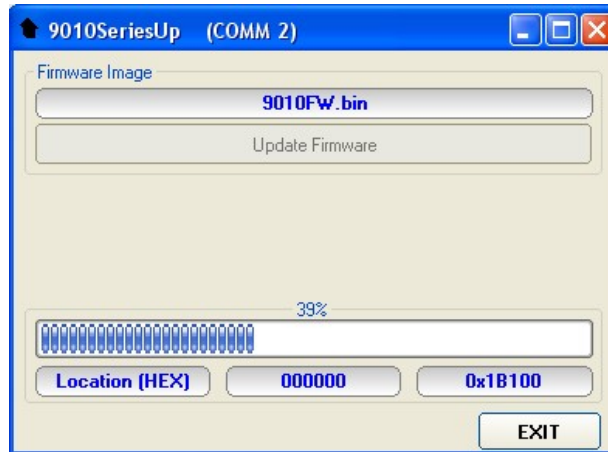

In the meanwhile on the 9010 display the BIOS page appears, showing again the updating status.

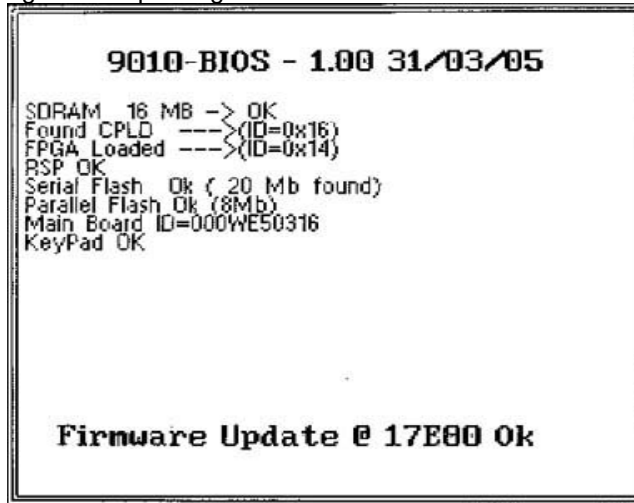

When FW download finishes, following message appears to show that everything was properly completed:



In case of failure, an error message is showed instead.

After Firmware Update is successfully completed, switch OFF and then ON again the PMM 9010, looking at screen, and then perform Auto-calibration.

Now at the top of the display a different FW Release Number and Date is showed after "9010-BIOS-...", as per the following:

In case the release should not comply with what expected, just check about the FW file used during installation or get in contact with the nearest NARDA Local Distributor.

It is now possible to disconnect the cable connected to the PC, with the PMM 9010 receiver either switched On or Off.



To obtain up-to-date Firmware or PC Utility for PMM 9010, the user can contact his NARDA distributor or download it directly from Support area of EMC Product Range on the following Web Site: www.narda-sts.it.



After having upgraded the internal firmware of the unit it is suggested to perform the Auto-calibration procedure as described in chapter 3.3.

8.6 9010 WrDongle Utility

The **WrDongle** utility allows to enable the function ordered such Options using the **40 Digit Activation Code** received from NARDA Italy.

Turn on the PMM 9010 and connect it to a free USB or RS232 port of the PC.



Be sure the baud rate of the RS232 port is set to 115200.

Browse for All Programs from the Start Menu and reach the **“WrDongle”** executable link:

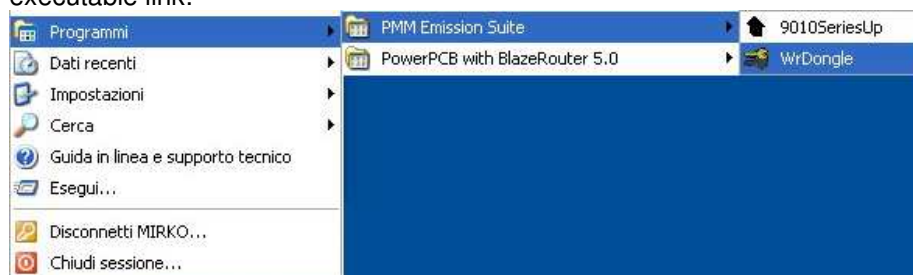

Main window displayed after the program **WrDongle** has been run:



Select **USB** or **RS232** communication port.

In case of RS232 communication, choose the COM port pressing the **Up** or the **Down** arrows.

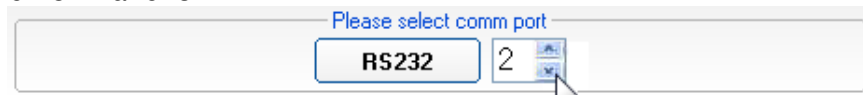

Move the cursor to the COM port number and select the left mouse button to highlight the box.

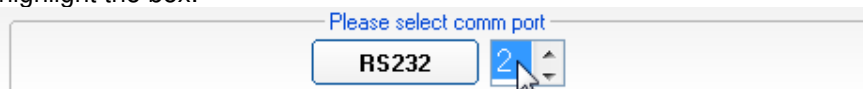

Press **RS232** button to set the com port.

The program will display the following window:

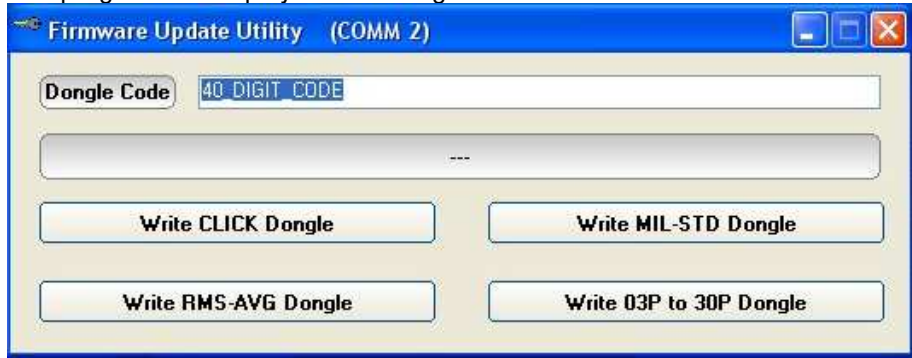

Copy and paste the **40 Digit Activation Code** to the “Dongle Code” input field and press the button below related to the specific Option:

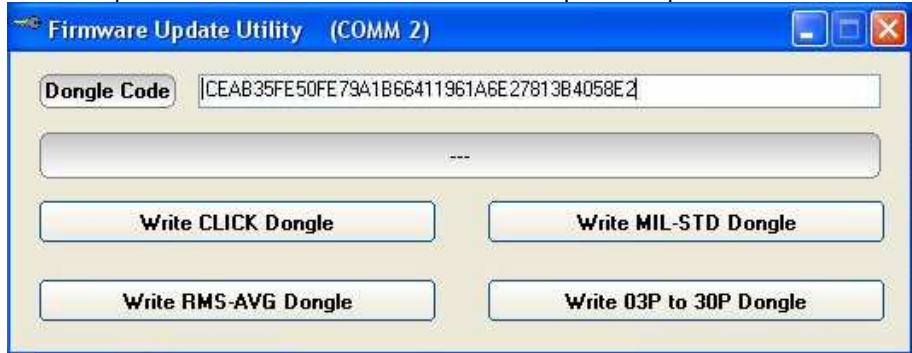

In case of failure, an error message is showed instead.

Always cycle OFF and ON the receiver to properly initialize the function.



For further information on activation procedure refer to the “Click Mode Operating Instructions”, “RMS-AVG and C-AVG Detectors”, and “Additional RBW Filters” chapter.



With the “Write 03P to 30P Dongle” button the 9010/03P can be upgraded to 9010/30P version for use up to 3 GHz; It is a payment special function implemented in the receiver. Please contact your local Narda distributor for details.

9 – PMM 9010/03P EMI CISPR Receiver
10 Hz ÷ 30 MHz Full Compliance
> 30 MHz Compliance (PRF ≥ 10Hz)

PMM 9010/30P EMI CISPR Receiver
10 Hz ÷ 30 MHz Full Compliance
30 MHz ÷ 3 GHz Pre Compliance

PMM 9010/60P EMI CISPR Receiver
10 Hz ÷ 30 MHz Full Compliance
30 MHz ÷ 6 GHz Pre Compliance
General Information

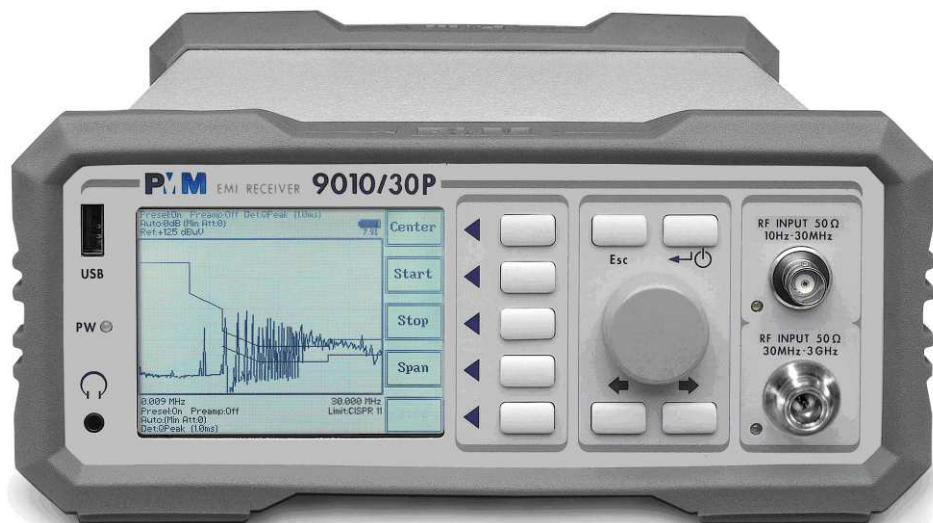
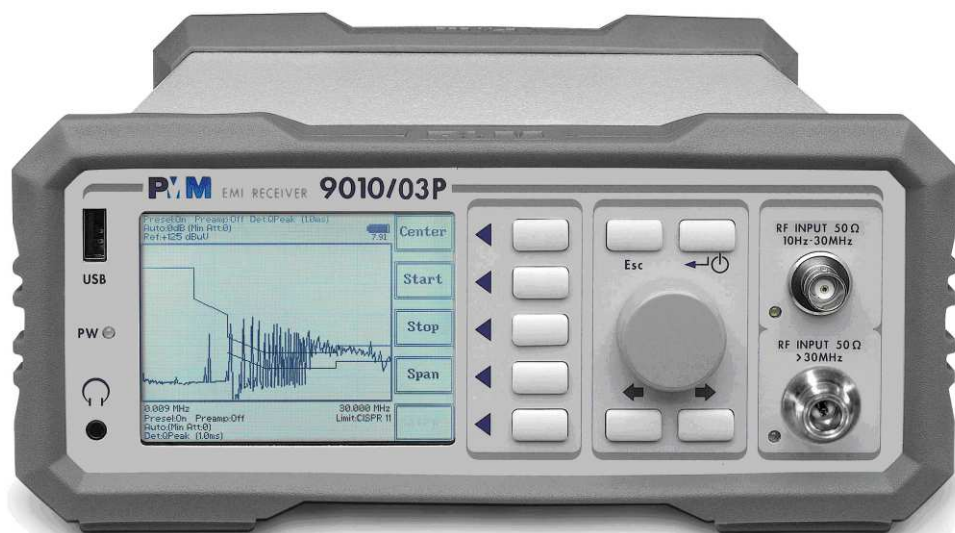

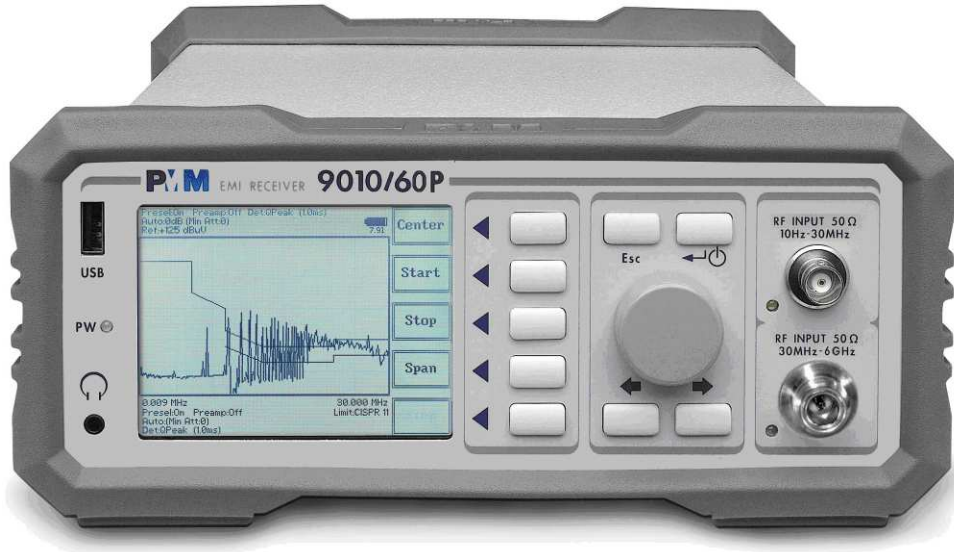

9.1 Documentation

Enclosed with this manual are:

- a service questionnaire to send back to NARDA in case an equipment service is needed
- an accessories checklist to verify all accessories enclosed in the packaging.

9.2 Operating Manual Changes

Instruments manufactured after the printing of this manual may have a serial number prefix not listed on the title page; this indicates that instruments with different Serial Number prefix may be different from those documented in this manual.

9.3 Introduction to PMM 9010/03P/30P/60P

PMM 9010/03P/30P/60P is an EMI receiver to measure conducted and radiated interferences from 10 Hz to 300 MHz (9010/03P), from 10 Hz to 3 GHz (9010/30P) and from 10 Hz to 6 GHz (9010/60P).

The 9010/03P is **Full Compliance** up to 30 MHz (A and B band) and **Compliance** 30 MHz up to 300 MHz (C band, PRF ≥ 10Hz).

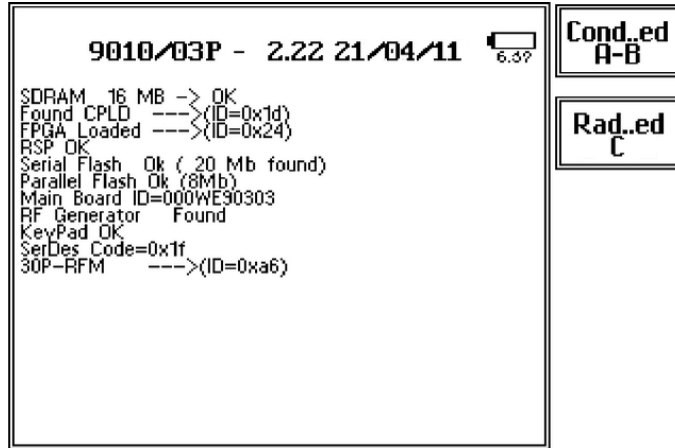

The 9010/03P can be upgraded to 9010/30P version for use up to 3 GHz; It is a payment special function implemented in the receiver. Please contact your local Narda distributor for details.

The 9010/30P is **Full Compliance** up to 30 MHz (A and B band) and **Pre-Compliance** 30 MHz up to 3 GHz (CDE bands).

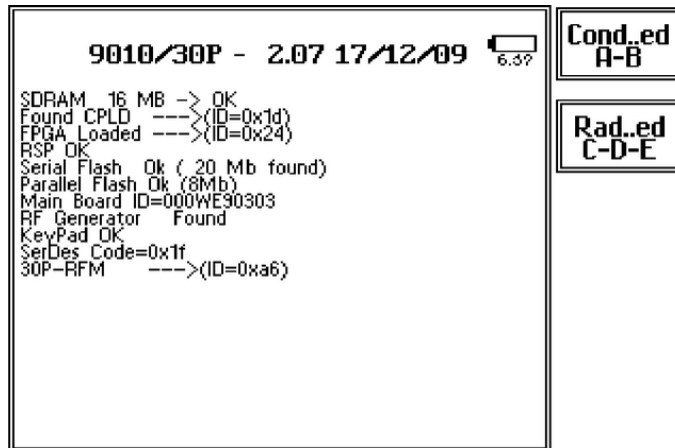

The 9010/60P is **Full Compliance** up to 30 MHz (A and B band) and **Pre-Compliance** 30 MHz up to 6 GHz (CDE bands).

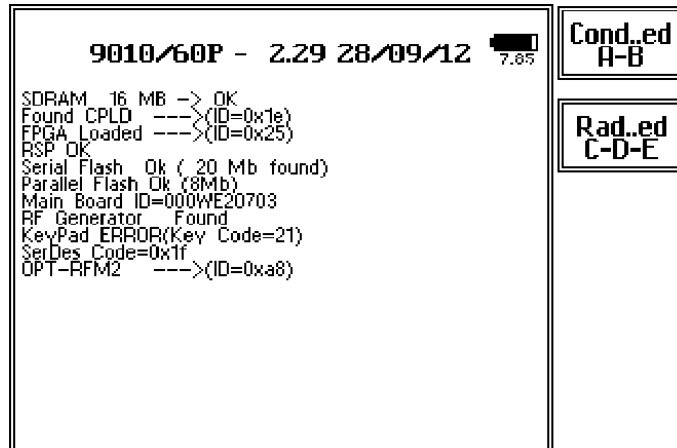

For what is concerning the use in full compliance A and B bands refer to the PMM 9010.

Refer to the PMM 9030/9060/9180 chapter for the main functions are included in Radiated emission measurements.

All measurements performed by the PMM 9010/03P/30P/60P are according to the most accepted standards like: IEC, CISPR, EN (EuroNorm), FCC, VDE,

Thanks to its built-in tracking generator up to 30MHz the PMM 9010/03P/30P/60P is also suitable for designing, characterizing and testing RF filters, transducers and other components.

The PMM 9010/03P/30P/60P has been designed adopting an innovative philosophy made possible only in the recent years by the availability of superior technology components. This equipment is fully digital but the input preselector and attenuator – and, of course, the output stage of the internal reference tracking generator - and therefore combines into a pure EMI Receiver and Signal Analyzer the precision and accuracy of a numeric approach, with flexibility and user friendly approach typical of a modern instrument.

9.4 Instrument Items

PMM 9010/03P/30P/60P includes the following items:

- PMM EMI Receiver;
- AC/DC Converter with plug adapters;
- Flexible black cover/accessories holding;
- BNC-BNC coaxial cable 2m length;
- N male to BNC fem. Adapter
- RS232 cable, 2m;
- USB-RS232 serial converter;
- USB cable, 2m;
- Operating manual;
- PMM 9010 Utility Software on Software Media;
- Certificate of Compliance;
- Return for Repair Form.

9.5 Optional accessories

- BP-02 Li-ion battery pack;
- Same optional accessories of 9010 unit (See par. 1.5)

9.6 Other accessories

- Same other accessories of 9010 unit (See par. 1.6)

**9.7 PMM 9010/03P
Main Specifications**

Table 9-1 lists the PMM 9010/03P performance specifications.
The following conditions apply to all specifications:

- The ambient temperature shall be 0°C to 40°C



For what is concerning the specifications of the A and B bands section refer to the specification of the 9010 in the chapter 1.

TABLE 9-1 Main Specifications for C bands	
Frequency range	30 MHz to 300 MHz
Resolution	100 Hz
Frequency accuracy	< 2 ppm
RF input	Z _{in} 50 Ω, N fem.
VSWR	
10 dB RF att.	< 1.2
0 dB RF att.	< 1.2
Attenuator	0 dB to 50 dB (2dB steps)
Max input level (without equipment damage)	
Sinewave AC voltage	137 dBμV (1 W)*
Pulse spectral density	97 dBμV/MHz
PRF (CISPR 16-1-1)	≥ 10Hz
IF bandwidth	
Standard 6 dB	3, 10, 30, 100, 300 kHz, 1 MHz
CISPR 16-1-1 bandwidth (6 dB)	120 kHz
MIL-STD-461 (option)	100 kHz, 1 MHz
Noise level	30 to 300 MHz < 8 dBμV (QP) (120 kHz RBW) < 4 dBμV (AV)
Spurious response	< 15 dBμV
Measurement accuracy S/N > 20 dB	± 1,0 dB
Operating temperature	0° to 40°C
Power supply	10 - 15 Volt DC, 2,5A; Optional Li-Ion interchangeable battery (8 h operations, typical)
Dimensions	235 x 105 x 335 mm
Weight	4.1 kg

(*) with MIN ATT ≥ 10 dB

9.8 PMM 9010/03P Front Panel

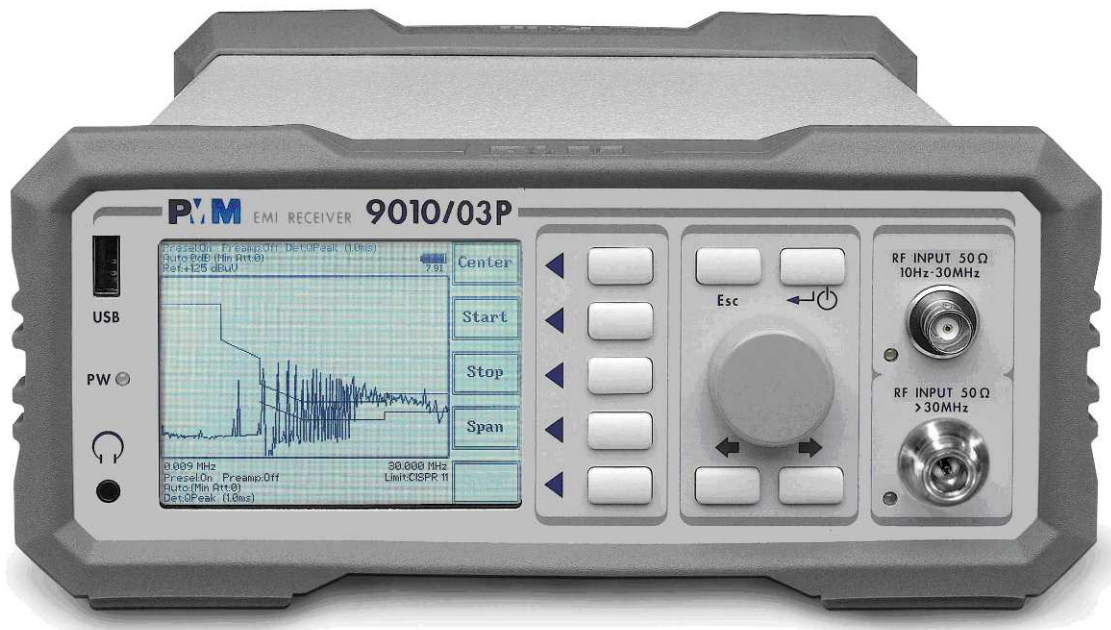



Fig. 9-1 Front Panel

Legend from left to right:

- **USB** USB 2.0 connection port (future implementation only)
- **PW** Power led
Indicates the power status
-  Earphone connector
To listen to the demodulated signals
- **DISPLAY** Main display
To graphically show the instrument status
- **User keys** 5 command keys
To select the various available functions
- **Controls** Rotary Knob, Left and Right (decrease / increase) Arrow Keys; Esc; Enter/Switch Key
The Rotary Knob and the Arrows Keys can be used to increase and decrease the setting values; the Esc key allows to return to the previous status/display; the Enter/switch key is used to confirm a set value and to switch On and Off the equipment
- **Input connectors**
Input from 10 Hz ÷ 30 MHz (BNC connector)
Input > 30 MHz (N connector)
- **“RF Input 50Ω 10 Hz ÷ 30 MHz” Led**
Indicates when the Receiver Input is active
- **“RF Input 50Ω > 30 MHz” led**
Indicates when the Receiver Input is active

9.9 PMM 9010/03P Rear Panel



Fig. 9-2 Rear Panel

Legend from left to right:

- **RS232** 9 pin, DB9 connector
- **USER PORT** User I/O Port
- **USB** Fully functional USB 2.0 Port
- **LINK1/LINK2** Optical link connectors for PMM equipments (Link 2 for future implementation)
- **Power Supply** Power Supply Inputs for use to power the apparatus and simultaneously charge its battery (PS1) and to simply charge the battery when it's out of the receiver (PS2).
- **Output connector** Tracking Generator Output
- **Fan** Cooling Fan controlled by firmware
- **Replaceable Li-Ion Battery (Fig. 9-3) with main Battery Charger connector**
- **Earth ground connector**
- **Product Label and Serial Number**



Fig. 9-3 BP-02 Replaceable Battery



To upgrade the firmware, install and use the PMM 9010/03P refer to PMM 9010 section.

**9.10 PMM 9010/30P
Main Specifications**

Table 9-2 lists the PMM 9010/30P performance specifications.
 The following conditions apply to all specifications:

- The ambient temperature shall be 0°C to 40°C



For what is concerning the specifications of the full compliance A and B bands section refer to the specification of the 9010 in the chapter 1.

TABLE 9-2 Main Specifications for CDE bands

Frequency range	30 MHz to 3 GHz
Resolution	100 Hz
Frequency accuracy	< 2 ppm
RF input	Z _{in} 50 Ω, N fem.
VSWR	
10 dB RF att.	< 1.2, <2.0 over 1 GHz
0 dB RF att.	< 1.2, <2.0 over 1 GHz
Attenuator	0 dB to 50 dB (2dB steps)
Max input level (without equipment damage)	
Sinewave AC voltage	137 dBμV (1 W)*
Pulse spectral density	97 dBμV/MHz
PRF (CISPR 16-1-1)	≥ 10Hz
IF bandwidth	
Standard 6 dB	3, 10, 30, 100, 300 kHz, 1 MHz
CISPR 16-1-1 bandwidth (6 dB)	120 kHz
MIL-STD-461 (option)	100 kHz, 1 MHz
Noise level	30 MHz to 3 GHz < 8 dBμV (QP) (120 kHz RBW) < 4 dBμV (AV)
Spurious response	< 15 dBμV
Measurement accuracy (S/N > 20 dB)	30 MHz to 1 GHz ± 1,0 dB 1 GHz to 3 GHz ± 1,5 dB
Operating temperature	0° to 40°C
Power supply	10 - 15 Volt DC, 2,5A; Optional Li-Ion interchangeable battery (8 h operations, typical)
Dimensions	235 x 105 x 335 mm
Weight	4.1 kg

(*) with MIN ATT ≥ 10 dB

9.11 PMM 9010/30P Front Panel

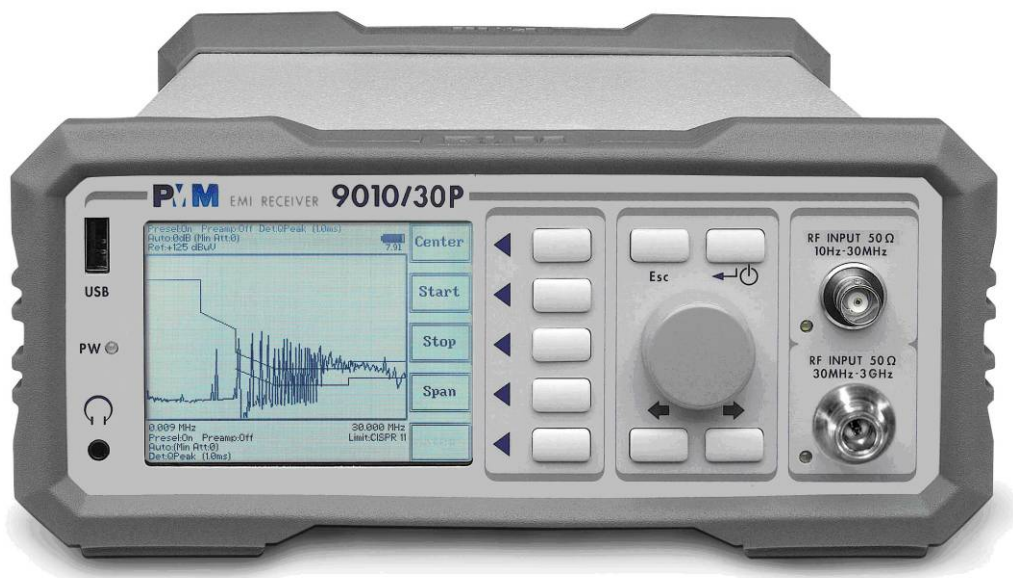



Fig. 9-4 Front Panel

Legend from left to right:

- **USB** USB 2.0 connection port (future implementation only)
- **PW** Power led
Indicates the power status
-  Earphone connector
To listen to the demodulated signals
- **DISPLAY** Main display
To graphically show the instrument status
- **User keys** 5 command keys
To select the various available functions
- **Controls** Rotary Knob, Left and Right (decrease / increase) Arrow Keys; Esc; Enter/Switch Key
The Rotary Knob and the Arrows Keys can be used to increase and decrease the setting values; the Esc key allows to return to the previous status/display; the Enter/switch key is used to confirm a set value and to switch On and Off the equipment
- **Input connectors**
Input from 10 Hz ÷ 30 MHz (BNC connector)
Input from 30 MHz ÷ 3 GHz (N connector)
- **“RF Input 50Ω 10 Hz ÷ 30 MHz” Led**
Indicates when the Receiver Input is active
- **“RF Input 50Ω 30 MHz ÷ 3 GHz” led**
Indicates when the Receiver Input is active

9.12 PMM 9010/30P
Rear Panel



Fig. 9-5 Rear Panel

Legend from left to right:

- **RS232** 9 pin, DB9 connector
- **USER PORT** User I/O Port
- **USB** Fully functional USB 2.0 Port
- **LINK1/LINK2** Optical link connectors for PMM equipments (Link 2 for future implementation)
- **Power Supply** Power Supply Inputs for use to power the apparatus and simultaneously charge its battery (PS1) and to simply charge the battery when it's out of the receiver (PS2).
- **Output connector** Tracking Generator Output
- **Fan** Cooling Fan controlled by firmware
- **Replaceable Li-Ion Battery (Fig. 9-6) with main Battery Charger connector**
- **Earth ground connector**
- **Product Label and Serial Number**



Fig. 9-6 BP-02 Replaceable Battery



To upgrade the firmware, install and use the PMM 9010/30P refer to PMM 9010 section.

9.13 PMM 9010/60P
Main Specifications



Table 9-3 lists the PMM 9010/60P performance specifications.

The following conditions apply to all specifications:

- The ambient temperature shall be 0°C to 40°C

For what is concerning the specifications of the full compliance A and B bands section refer to the specification of the 9010 in the chapter 1.

TABLE 9-3 Main Specifications for CDE bands

Frequency range	30 MHz to 6 GHz
Resolution	100 Hz
Frequency accuracy	< 2 ppm
RF input	Z _{in} 50 Ω, N fem.
VSWR	
10 dB RF att.	< 1.2, <2.0 over 1 GHz
0 dB RF att.	< 2.0, <3.0 over 3 GHz
Attenuator	0 dB to 55 dB (5dB steps)
Max input level (without equipment damage)	
Sinewave AC voltage	137 dBμV (1 W)*
Pulse spectral density	97 dBμV/MHz
PRF (CISPR 16-1-1)	≥ 10Hz
IF bandwidth	
Standard 6 dB	3, 10, 30, 100, 300 kHz, 1 MHz
CISPR 16-1-1 bandwidth (6 dB)	120 kHz
MIL-STD-461 (option)	100 kHz, 1 MHz
Noise level	
30 to 300 MHz (120 kHz BW)	< 10 dBuV (QP) < 7 dBuV (AV)
300 to 3000 MHz (120 kHz BW)	< 13 dBuV (QP) < 7 dBuV (AV)
3000 to 6000 MHz (120 kHz BW)	< 15 dBuV (QP) < 10 dBuV (AV)
Spurious response	< 10 dBμV, < 15 dBμV over 2 GHz
Measurement accuracy (S/N > 20 dB)	
30 MHz to 1 GHz	± 1,0 dB
1 GHz to 3 GHz	± 1,5 dB
3 GHz to 6 GHz	± 2,0 dB
Operating temperature	0° to 40°C
Power supply	10 - 15 Volt DC, 2,5A; Optional Li-Ion interchangeable battery (8 h operations, typical)
Dimensions	235 x 105 x 335 mm
Weight	4.1 kg

(*) with MIN ATT ≥ 10 dB

9.14 PMM 9010/60P
Front Panel

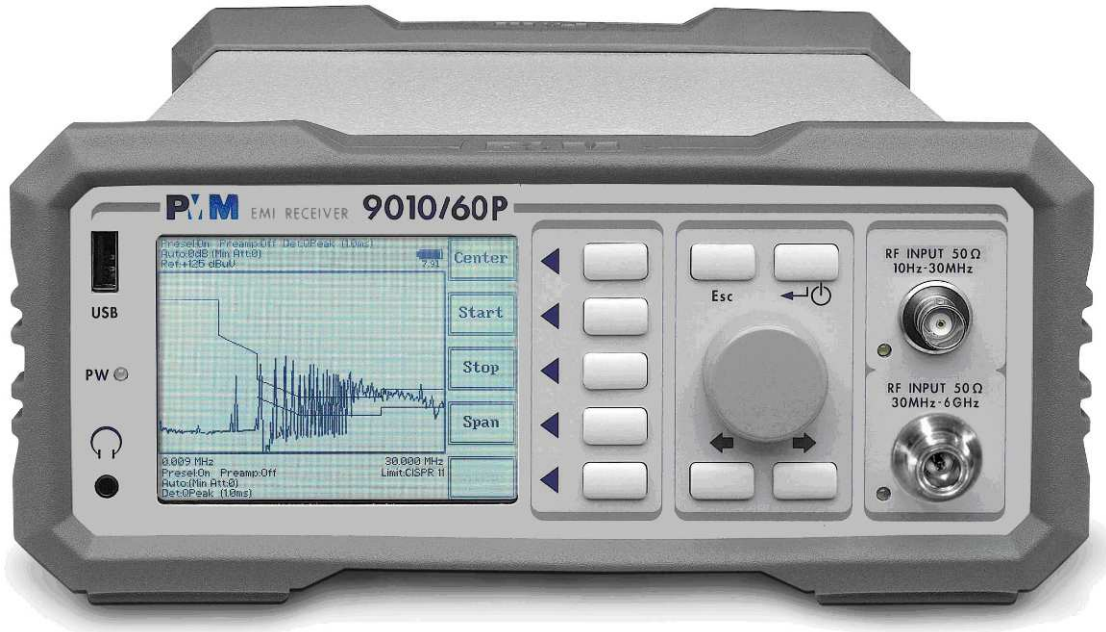



Fig. 9-7 Front Panel

Legend from left to right:

- **USB** USB 2.0 connection port (future implementation only)
- **PW** Power led
Indicates the power status
-  Earphone connector
To listen to the demodulated signals
- **DISPLAY** Main display
To graphically show the instrument status
- **User keys** 5 command keys
To select the various available functions
- **Controls** Rotary Knob, Left and Right (decrease / increase) Arrow Keys; Esc; Enter/Switch Key
The Rotary Knob and the Arrows Keys can be used to increase and decrease the setting values; the Esc key allows to return to the previous status/display; the Enter/switch key is used to confirm a set value and to switch On and Off the equipment
- **Input connectors**
Input from 10 Hz ÷ 30 MHz (BNC connector)
Input from 30 MHz ÷ 6 GHz (N connector)
- **“RF Input 50Ω 10 Hz ÷ 30 MHz” Led**
Indicates when the Receiver Input is active
- **“RF Input 50Ω 30 MHz ÷ 6 GHz” led**
Indicates when the Receiver Input is active

9.15 PMM 9010/60P
Rear Panel

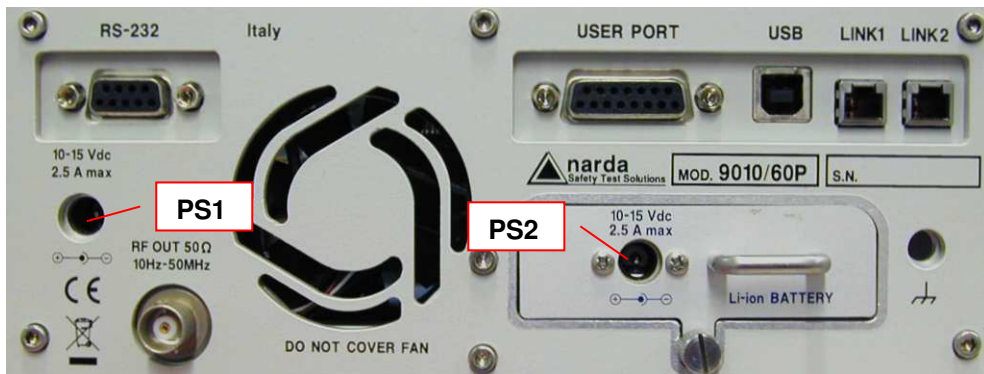

Fig. 9-8 Rear Panel

Legend from left to right:

- **RS232** 9 pin, DB9 connector
- **USER PORT** User I/O Port
- **USB** Fully functional USB 2.0 Port
- **LINK1/LINK2** Optical link connectors for PMM equipments (Link 2 for future implementation)
- **Power Supply** Power Supply Inputs for use to power the apparatus and simultaneously charge its battery (PS1) and to simply charge the battery when it's out of the receiver (PS2).
- **Output connector** Tracking Generator Output
- **Fan** Cooling Fan controlled by firmware
- **Replaceable Li-Ion Battery (Fig. 9-6) with main Battery Charger connector**
- **Earth ground connector**
- **Product Label and Serial Number**



Fig. 9-9 BP-02 Replaceable Battery



To upgrade the firmware, install and use the PMM 9010/60P refer to PMM 9010 section.

This page has been left blank intentionally

10 - Click Mode Operating Instructions (Option)

10.1 Introduction



The **CLICK mode** allows the User to make in a fast, easy and fully automatic way a difficult test like the Discontinuous Disturbances measurement, as defined by current CISPR standards.

10.2 Click Mode Activation Procedure



To enable the Click mode use the 9010 Set code Utility

For further information on software installation, refer to the “Updating firmware and Activation code Utility” chapter.

Click on “**9010 Set code Utility**” (WrDongle.EXE) once for running the Set code program, so getting the following window:



Choose the proper COM port from the drop-down menu and click the **RS232** button.

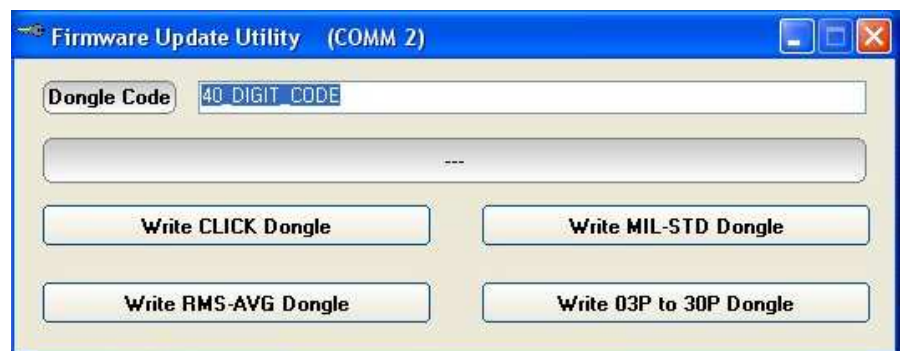

Copy the 40 Digit Serial Code in the Dongle Code Window and select the **Write CLICK Dongle** button.

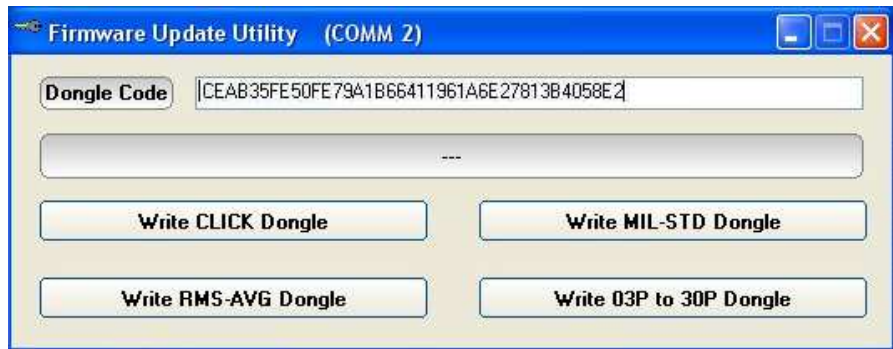

This message appears when the Dongle code is not valid



When everything works correctly, the following message will be shown. Then press **OK** to confirm.

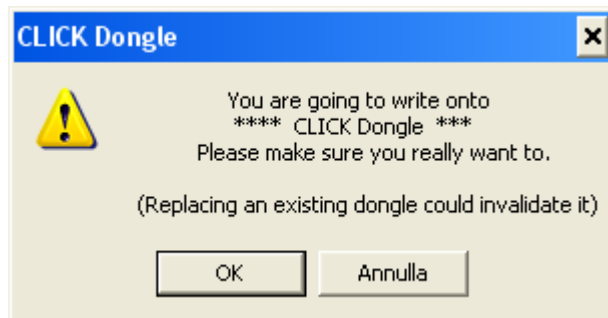

The software will inform that the Dongle Code has been successfully stored. Press **Ok** to close the program.





Click activation confirm

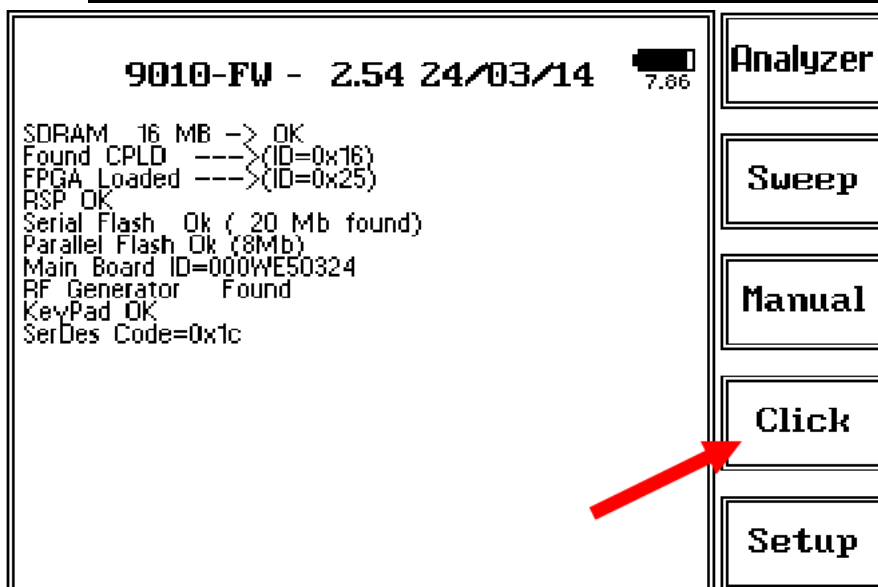

When the Click option has been successfully activated, the 4th menu button appears as indicated in the picture above.

10.3 Enter the Click Mode



To enter **Click Mode**, press the corresponding key in the main menu, and immediately the first window opens as following:

With PMM 9010/03P /30P /60P press the **Cond..ed A-B** key in the initial menu to enter the main menu where the Click Mode button appears.

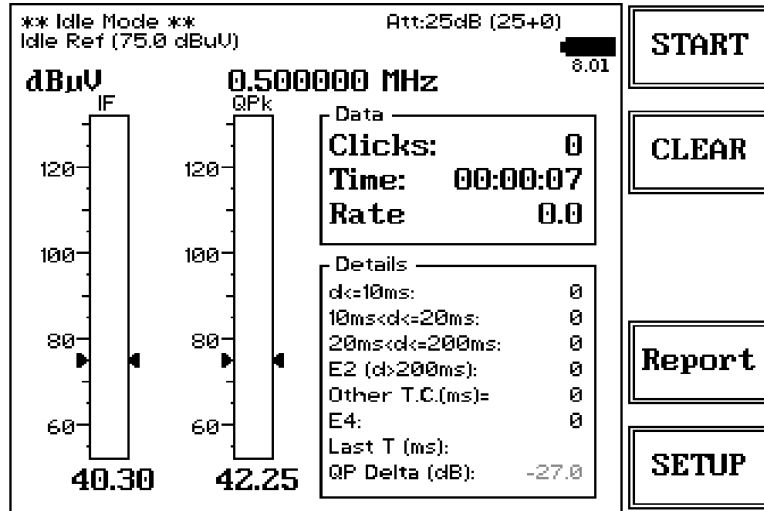

Fig. 10-1 Click

This is the **IDLE** function, which allows a preliminary, free running evaluation, at the selected frequency and level.

The Click mode function has four commands:

- Start
- Clear: cancel and reset all data to start an idle test;
- Report
- SETUP

Always use Esc button to return to the previous view/condition.



To increase test productivity the PMM 9010, PMM 9010/03P/30P/60P or PMM 9010F has some very unique features: it allows skipping as many as 2 steps, as it may predict how many clicks would overcome the Lq limit and may also advise the User if the next step would fail.

Moreover, it makes a true Qpeak measure and not a mere threshold comparison, as only a fully digital receiver can detect whether a Qpeak level came from an unsaturated signal or not; an analogue analyzer only has the final weighted Qpeak.



10.4 Introduction to the discontinuous disturbance (click) measurement

Mechanical or electronic switching procedures - e.g. those due to thermostats or program controls – may unintentionally generate broadband discontinuous disturbances with a repetition rate lower than 1 Hz.

Indeed, CISPR 16-2-1 and CISPR 14-1 define a discontinuous disturbance, also called “click”, as a disturbance the amplitude of which exceeds the quasi-peak limit of continuous disturbance, the duration of which is not longer than 200 ms and which is separated from a subsequent disturbance by at least 200 ms. The durations are determined from the signal which exceeds the IF reference level of the measuring receiver.

A click may also contain a number of impulses; in which case the relevant time is that from the beginning of the first to the end of the last impulse.

The test procedures and the test setup for click measurement are indicated in CISPR 16-2-1 and in CISPR 14-1 standards.

It basically consists in the measurement of the number of clicks exceeding a certain level determined as function of the click number and duration.

The PMM 9010 has a better than 500µs time resolution, as requested by the standard.

Moreover, several “exceptions” shall be dealt with by the click analyzer in order to make the test as per the standard.

To better understand the click measurement process – automatically made by PMM 9010 - it could be useful also to know few more definitions:

- *switching operation*: one opening or closing of a switch or contact;
- *minimum observation time T*: the minimum time necessary when counting clicks (or switching operations) to provide firm evidence for the statistical interpretation of the number of click (or switching operations) per time unit;
- *click rate N*: number of clicks or switching operations within one minute (this figure is being used to determine the click limit);
- *Click limit L_q*: the relevant limit L for continuous disturbance for the measurement with the quasi-peak detector, increased by a certain value (offset) determined from the click rate N. The click limit applies to the disturbance assessed according to the upper quartile method;
- *Upper quartile method*: a quarter of the number of the clicks registered during the observation time T is allowed to exceed the click limit L_q. In the case of switching operations a quarter of the number of switching operations registered during the observation time T is allowed to produce clicks exceeding the click limit L_q.
- *short click 1*: a disturbance not longer than 10 ms;
- *short click 2 (E3)*: a disturbance between 10 ms and 20 ms;
- *click*: a disturbance longer than 10 ms and not longer than 200 ms;
- *other than click*: a discontinuous disturbance longer than 200 ms.

With reference to the mentioned standards, a schematic process flow of the measurement is the following:

- ☒ Determination of the click rate *N*
- ☒ Pass/fail decision if instantaneous switching and if $N \geq 30$
- ☒ Check conformity to definitions
- ☒ Apply Exceptions (whenever applicable)
- ☒ Calculate Limit Quartile
- ☒ Measurement using Upper Quartile Method
- ☒ Pass/fail using Upper Quartile criterion
- ☒ Repeat for next frequency

As PMM 9010 manages all these steps in a completely automatic way, a detailed step by step description is here given before to describe each command and function.

10.4.1 Determination of the click rate

The first step of the measuring process is to determine the click rate N in the minimum observation time. This is done measuring the time needed to count up to 40 clicks or 40 switching operations; the maximum time allowed is anyway 2 hours (120 minutes), unless the cycle is determined by a program, which needs additional time to be terminated.

Therefore, if the equipment has a cycle and in this cycle less than 40 clicks appear, then the cycle shall be repeated until 40 clicks are counted or until the observation time is 2 hours.

If the equipment has a cycle and in this cycle more than 40 clicks appear, the observation time is anyway determined by the cycle.

When the minimum observation time has been defined, it is possible to calculate the click rate N using the simple relationship:

$$N = \frac{n_1}{T}$$

where n_1 is the number of clicks measured and T is the minimum observation time.

However, in certain conditions – see CISPR 14-1 for further reference – the click rate N must be calculated using a different approach:

$$N = \frac{n_2 \cdot f}{T}$$

where n_2 is the number of switching operations and f is a factor dictated in the standard. Such a factor can be taken into account for automatic calculations if its value is properly set in the main setup page.

The click rate shall be determined at two frequencies: 150 kHz (Step 1) and 500 kHz (Step 3).

10.4.2 Preliminary Conformity and Exceptions

Once the number of clicks – or switching operations – has been determined, then some preliminary controls can be made to verify if the rate is greater than 30 (fail conditions); if the measured clicks are conforming to the definition of the standard; if there are exceptions applicable.

Thanks to its digital architecture, PMM 9010 can easily record and store all the relevant parameters, keeping trace of all the events occurring during the test and allowing the User to post-process all these data; PMM 9010 will also notify immediately the test results to the User.

10.4.2.1 Old and New exceptions

The “Click” test also requires verifying if exceptions E1 to E4 are applicable. While E1 and E2 are “old” exceptions, easy to deal with, the new E3 and, in particular, E4 are calling for a new hardware structure: an old click analyzer is no longer compliant.

E3 is an additional counter, does not require additional memory and implies only minor changes in the test flow, thus can be implemented in a relatively easy way.

E4 is very demanding in terms of hardware requirements: a memory for storing each disturbance duration and interval is required in order to post-elaborate them, and it is mandatory to provide all the data in the test report. Moreover, as the application of E4 is conditional to the final click rate N - which in turn may prevent using E4 – the test flow significantly changes.

Only new analysers specifically designed – like the PMM 9010 - can successfully meet the requirements of the standard and be compliant with the new Click test criteria.

10.4.3 Calculate Limit Quartile

When the click rate N is determined it is possible to calculate the click limit L_q by increasing the relevant limit (quasi-peak) L for continuous disturbances with:

- ⊗ 44 dB for N<0,2, or
- ⊗ 20 log (30/N) dB for 0,2<N<30

Therefore

$$L_q = L + 20 \cdot \text{Log} \frac{30}{N}$$

10.4.4 Measurement vs. L_q limit

Now the test can be done at the 4 fixed frequencies dictated by the standard: 150 kHz, 500 kHz, 1.4 MHz, 30 MHz, and the results compared with the limit L_q.

If less than 25% of the clicks measured exceeds the limit L_q, then the test is positive, otherwise it fails.

The PMM 9010 can now produce an extensive report with all the relevant data.

10.5 Start

As soon as the Setup has been done (see § 9.5), it is possible to start the test.

Step 1: Determining N

First of all the PMM 9010 will determine the click rate N, and – if all the conditions apply – after that the analyzer will immediately continue measuring the number of clicks exceeding the upper quartile limit L_q.

Simply select **Start**: the PMM 9010 will automatically take care of all the necessary steps, reporting at the end of the test all the relevant results.

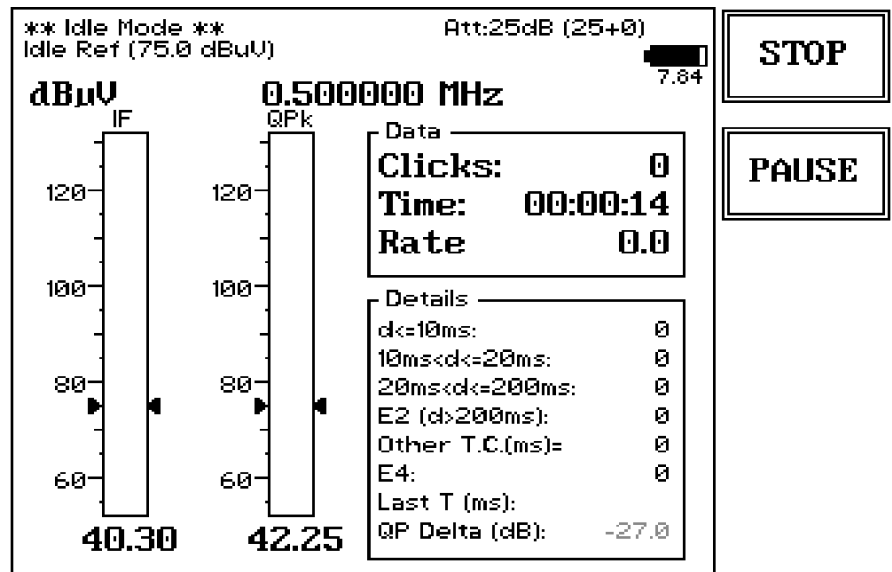

During the test, the evolution of the measurements can be continuously controlled in the Data and Details windows, where all the info are duly provided.

At any time, it is possible to **Stop** the measure or to **Pause** it.

The PMM 9010 does the determination of the click rate at the two frequencies of 150 kHz (**Step 1**) and 500 kHz (**Step 3**).

Step 2: Testing (allowed:1)

After the Step 1 is completed, the **Step 2** begins automatically, carrying out the measurements vs Lq limit, or, in other words, performing the heart of the test itself.
 In brackets, it is reported the max clicks number allowed (25% of the clicks measured during Step 1).



Step 3 and **Step 4** are similar to Step 1 and 2 for the 500 kHz frequency.

Then **Step 5** and **Step 6** are similar to Step 4, for 1.4 MHz and 30 MHz respectively, with same time duration and limit.



At the right upper corner of the screen, you can find the input attenuation indication.

Att:35dB (15+20)

In the example above, the total attenuation is 35dB, divided in 15dB internal and 20dB external. The value of the external attenuator can be inserted into the main Settings page, as explained later in this chapter.



In certain conditions, the analyzer may judge the input attenuation is not adequate (for example, when the limit is recalculated following up the Lq value): in that case, a screen like the following appears, and requires additional attenuation.

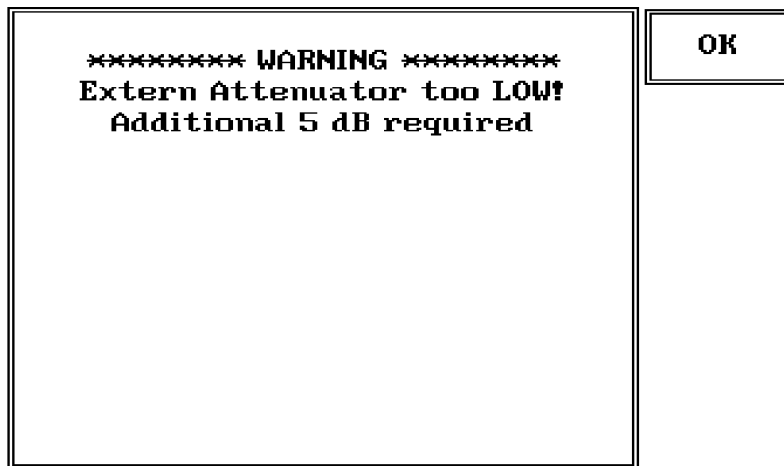

In most cases, it is enough to touch **OK** to adjust the input attenuation to the optimum value and continue the test.



The total amount of available internal attenuation is 45 dB in Click mode, because also the pulse limiter 10 dB pad is used.

The provided 20dB external attenuator should be adopted when at least 20dB more attenuation is required.

Please remember that the maximum input signal allowed is 7 V (137 dBμV), and that a click test may result in a potentially dangerous condition for the input stage of the receiver.



Before to apply an unknown signal to PMM 9010 receiver, use an oscilloscope or a wide band RF voltmeter to measure it.

If needed, add a coaxial attenuator to the input signal line (a 20dB external attenuator is always provided with PMM 9010-Click Option).

10.5.1 Stop and Pause

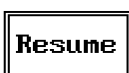

If Stop has been selected during a measurement, the test can then be aborted or it is possible to go immediately to the next step.

If Paused, the test can be resumed at any convenient time.

10.6 Report

After a Click test the PMM 9010 reports all the relevant data. Due to the complexity of the test and to the various conditions that may happen during the measurement, several reports may be issued. Here following some examples well representing the completeness and the accuracy of the analyzer.

10.6.1 Fail during determination of the click rate N

In case a fail is recorded during the determination of the click rate N at the frequency of 150 kHz, a report like the following is displayed (which is just an example with a not-realistic N number):

Lq Calculation										
Freq	Limit	10ms	20ms	0.2s	E4	o.t.o	Total	Time	N	+Lq
0.15	66.0	338	3	907	0	412	1249	2.9	428.5	FAIL

If the fail occurs during the determination of the click rate at 500 kHz, the report may be like this:

Lq Calculation										
Freq	Limit	10ms	20ms	0.2s	E4	o.t.o	Total	Time	N	+Lq
0.50	56.0	169	85	280	0	753	535	1.5	364.7	FAIL

10.6.2 Report after a successful test with less than 5 instantaneous switching at one frequency

If the determination of the click rate N shows that at a given frequency (500 kHz in this examples) there are less than 5 instantaneous switching operations, there is no need of any further test at that frequency or frequencies (the investigation frequencies are 150 kHz for the interval from 150 to 500 kHz, and 500 kHz for the interval from 500 kHz to 30 MHz). In the example, L_q is calculated for 150 kHz and no tests are done at the other frequencies, as the number in instantaneous switching at 500 kHz during the observation time is less than 5.

Lq Calculation										
Freq	Limit	10ms	20ms	0.2s	E4	o.t.o	Total	Time	N	+Lq
0.15	66.0	0	0	0	(30)	600	1	1.0	1.0	29.5
0.50	56.0	0	0	0	0	0	0	1.0	0.0	PASS

Final Test Report										
Freq	Lq	10ms	20ms	0.2s	E4	o.t.o	Total	Time	Max	P/F
0.15	95.5	0	0	0	0	0	0	2.2	0	Pass

To complete the test of the example above, only the steps 1, 2 and 3 were performed.

10.6.3 Report after a successful test at 4 frequencies

Here following the example of a report for a test done on all the defined frequencies, from Step 1 to Step 6. All the relevant information is provided.

Lq Calculation										
Freq	Limit	10ms	20ms	0.2s	E4	o.t.c	Total	Time	N	+Lq
0.15	66.0	0	0	0	(50)	341	1	1.0	1.0	29.5
0.50	56.0	0	0	0	(24)	311	1	1.0	1.0	29.5

Final Test Report										
Freq	Lq	10ms	20ms	0.2s	E4	o.t.c	Total	Time	Max	P/F
0.15	95.5	0	0	0	0	0	0	1.0	0	Pass
0.50	85.5	0	0	0	0	0	0	1.0	0	Pass
1.40	85.5	0	0	0	0	0	0	1.0	0	Pass
30.00	89.5	0	0	0	0	0	0	1.0	0	Pass

10.6.4 Report after a line search

When connected to a PMM LISN, the PMM 9010 can also automatically search for the worst line, defined as the one with the higher rate N. The Search Frequency can be set in the main Setup page.

After having found the noisiest line, the analyzer starts with the normal test flow (determination of N, etc.) measuring on the worst line. An example of report when the worst line search has been requested is as follows:

Worst Line Search										
Line	Limit	10ms	20ms	0.2s	E4	o.t.c	Total	Time	N	Worst
L3-1	75.0	3	1	5	0	1203	9	1.0	9.1	X
L3-2	75.0	2	0	0	0	241	3	0.2	17.2	.
L3-3	75.0	1	0	0	0	0	1	0.1	10.5	.
L3-N	75.0	0	0	9	0	0	9	0.4	24.1	.

Lq Calculation										
Freq	Limit	10ms	20ms	0.2s	E4	o.t.c	Total	Time	N	+Lq
0.15	75.0	0	0	4	0	335	5	0.4	12.2	7.8
0.50	75.0	6	0	2	0	0	8	0.5	15.5	5.7

Final Test Report										
Freq	Lq	10ms	20ms	0.2s	E4	o.t.c	Total	Time	Max	P/F
0.15	82.8	0	0	0	0	0	0	0.4	1	Pass
0.50	80.7	0	0	0	0	212	1	0.5	2	Pass
1.40	80.7	0	0	0	0	0	0	0.5	2	Pass
30.00	80.7	0	0	0	0	0	0	0.5	2	Pass

In this case 4 worst line searches are done at first, followed by the usual six measurements, from Step 1 to Step 6.

10.7 Setup

Due to the complexity of the discontinuous disturbance test, this panel is rather complex, as many parameters shall be defined. However, the PMM 9010 has been designed to be extremely user-friendly and to take care in a fully automatic way of all the necessary steps of the test.



Due to the fact that the Standard fixes the frequencies at which the test shall be done, these frequencies have been uniquely assigned by factory and the User cannot modify them; nevertheless it is possible to select an arbitrary Frequency Value for "Idle Mode" instead, useful for debugging purposes.

From the main Click window, select SETUP and the main Setup panel will be displayed. The User can navigate through the different parameters rotating the control knob.

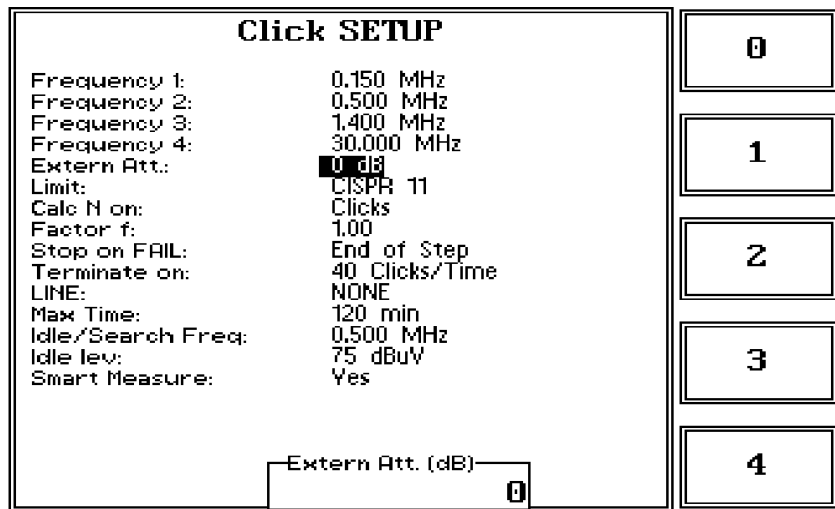

10.7.1 External attenuator

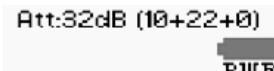
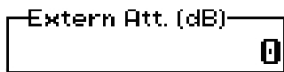

In case an external attenuator is used to protect the input of the analyzer, the value of this attenuator can be entered, in order to have the PMM 9010 taking into account the value in all calculations of measured levels. The way to enter the value of the attenuator is the same adopted in all the other modes (see for examples §4.2).

The inserted value will be displayed together with the others automatically adjusted by the receiver; all such attenuations values will be resumed between brackets at the top right of the screen, where the External Attenuator value will appear as the last shown number.

The 1st value between brackets is the one automatically assigned by 9010 receiver according to the selected Limit, in order to guarantee the proper input sensitivity defined by the Standard.

The 2nd value between brackets is a fixed number instead, depending only on the attenuation provided by the 4 channels simultaneous click detection, i.e. two numbers only will appear in the sum between brackets when the PMM 4-Channels Click Extension Box will not be used (PMM 9010 Click4E option).

A 20dB external attenuator is provided in the PMM 9010-Click Option kit, which has to be taken into account in this field when inserted at the RF input.

10.7.2 Limit

Click SETUP

Frequency 1:	0.150 MHz
Frequency 2:	0.500 MHz
Frequency 3:	1.400 MHz
Frequency 4:	30.000 MHz
Extern Att.:	0 dB
Limit:	██████████
Calc N on:	Clicks
Factor f:	1.00
Stop on FAIL:	End of Step
Terminate on:	40 Clicks/Time
LINE:	NONE
Max Time:	120 min
Idle/Search Freq:	0.500 MHz
Idle lev:	75.00 dBuV
Smart Measure:	No

022

014

011

NONE

Three most used limits are built-in into the analyzer: CISPR 14, CISPR22 and CISPR11.

Either one can be selected simply by pressing the relevant key.

The limit will be loaded and all the calculations will be done with reference to the selected limit:

014-1

014-2

014-3

014-4

The Reference Standard for Click tests is always EN 55014-1 (or equivalent CISPR 14-1), which defines 4 different Limit Curves for Q-Peak according to Table 1, with following cross-correlation as for names assigned on 9010 :

- 014-1 --> Limit in Column 2
- 014-2 --> Limit in Column 6
- 014-3 --> Limit in Column 8
- 014-4 --> Limit in Column 10



Limit in Column 4 of Tab.1 is not used for Click test, as referred to Load and Auxiliary terminals.

10.7.3 Determination of N As required by the standard, N may be determined either by counting the clicks, or by counting the switching operations.

Click SETUP	
Frequency 1:	0.150 MHz
Frequency 2:	0.500 MHz
Frequency 3:	1.400 MHz
Frequency 4:	30.000 MHz
Extern Att.:	0 dB
Limit:	CISPR 11
Calc N on:	Clicks
Factor f:	1.00
Stop on FAIL:	End of Step
Terminate on:	40 Clicks/Time
LINE:	NONE
Max Time:	120 min
Idle/Search Freq:	0.500 MHz
Idle lev:	75 dBuV
Smart Measure:	Yes

Clicks

Sw.Op.
+

Sw.Op.
-

Select **Clicks** if N has to be calculated on the number of clicks, or select **Sw.Op.+** or **Sw.Op.-** to determine N on the number of switching operations, going up and down the list of the available options in terms of switched current: 10mA; 20 mA; 50 mA; 100mA; 200mA; 500mA; 1A; 2A and 5A. The current threshold value must be chosen in relation to the DUT declared consumption.

Refer to § 10.9 for the connections to the external Switching Box, indispensable when you need to measure the switching operations.

10.7.4 Factor f

f Factor

i

The applicable standard may require a certain factor f to be used to calculate the click rate N (see § 9.2.1). For example, table A2 of the CISPR14 gives the factor f for several products.

This factor depends on the nature of the EUT and shall be entered by the User in the normal way (see for example §4.2).

10.7.5 Stop on Fail

The Click test may be rather long, as the observation time and EUT cycle can take as long as 120 minutes.

In order to save time and increase productivity, the PMM 9010 can stop the test as soon as a fail condition is achieved.

Two options are therefore available: stop immediately as the fail condition occurs (Right away) or anyway at the End of Step.

Press Change to flip from one to the other option.

Click SETUP	
Frequency 1:	0.150 MHz
Frequency 2:	0.500 MHz
Frequency 3:	1.400 MHz
Frequency 4:	30.000 MHz
Extern Att.:	0 dB
Limit:	CISPR 11
Calc N on:	Clicks 10mA
Factor f:	1.00
Stop on FAIL:	Right away
Terminate on:	40 Clicks/Time
LINE:	NONE
Max Time:	120 min
Idle/Search Freq:	0.500 MHz
Idle lev:	75 dBuV
Smart Measure:	No

Change

10.7.6 Terminate on

To define the automatic stop condition, it is possible to select between two options: 40 Clicks/Time and Time/Manually. In the first case, the stop of the step either happens after 40 clicks or after the defined time has elapsed; in the second case, the step is not terminated when reaching 40 clicks (thus allowing to test EUTs that are commanded by a program) but only when the defined time has elapsed. It is always possible to stop the step, and even the test, manually.

Press Change to flip from one to the other option.

Click SETUP		Change
Frequency 1:	0.150 MHz	
Frequency 2:	0.500 MHz	
Frequency 3:	1.400 MHz	
Frequency 4:	30.000 MHz	
Extern Att.:	0 dB	
Limit:	CISPR 11	
Calc N on:	Clicks/10mA	
Factor f:	1.00	
Stop on FAIL:	Right away	
Terminate on:	Time/Manually	
LINE:	NONE	
Max Time:	120 min	
Idle/Search Freq:	0.500 MHz	
Idle lev:	75 dBuV	
Smart Measure:	No	

10.7.7 Line

When using a PMM LISN, it's possible to select the Line on which to perform the test through the Setup Menu, just selecting "LINE" and accessing the related sub-menu, as per the following:

Click SETUP		Set
Frequency 1:	0.150 MHz	
Frequency 2:	0.500 MHz	
Frequency 3:	1.400 MHz	
Frequency 4:	30.000 MHz	
Extern Att.:	0 dB	
Limit:	CISPR 11	
Calc N on:	Clicks	
Factor f:	1.00	
Stop on FAIL:	End of Step	
Terminate on:	40 Clicks/Time	
LINE:	NONE	
Max Time:	120 min	
Idle/Search Freq:	0.500 MHz	
Idle lev:	75 dBuV	
Smart Measure:	Yes	

Default

In case a 3rd party LISN would be used, just leave "NONE" in the menu.

Once the PMM LISN sub-menu has been selected, a choice is available to define if to run the test on a specific Line (L1, L2, L3, N)

L2 PMM	Click SETUP Frequency 1: 0.150 MHz Frequency 2: 0.500 MHz Frequency 3: 1.400 MHz Frequency 4: 30.000 MHz Extern Att.: 0 dB Limit: CISPR 11 Calc N on: Clicks Factor f: 1.00 Stop on FAIL: End of Step Terminate on: 40 Clicks/Time LINE: NONE Max Time: 120 min Idle/Search Freq: 0.500 MHz Idle lev: 75 dBuV Smart Measure: Yes	L2 PMM
L3 PMM		L3 PMM
NONE		NONE

or to perform the test automatically on each test frequency, one Line after the other, in order to find the worst of them in terms of Emission

Click SETUP Frequency 1: 0.150 MHz Frequency 2: 0.500 MHz Frequency 3: 1.400 MHz Frequency 4: 30.000 MHz Extern Att.: 0 dB Limit: CISPR 11 Calc N on: Clicks Factor f: 1.00 Stop on FAIL: End of Step Terminate on: 40 Clicks/Time LINE: L3-PMM L1 L2 L3 N Max Time: 120 min Idle/Search Freq: 0.500 MHz Idle lev: 75 dBuV Smart Measure: Yes	L1
	L2
	L3
	N
	ALL

and finally execute the complete test on that specific Line only, so dramatically reducing time consumption.

10.7.8 Max Time

To define the duration of the test it's enough to enter the relevant time in minutes in the usual way.

10.7.9 Idle Frequency

Any frequency within the receiver range can be selected for preliminary investigation in Idle Mode.

0,15 – 0,5 – 1,4 – 30 MHz are the standard channels, preset at the factory, for the final test procedure.

10.7.10 Idle Level

An arbitrary Level for the Emission Limit can be chosen in Idle Mode, just to apply a certain tolerance in the debugging phase with respect to the limit, which will be mandatory at the final test stage.

The threshold level allowed ranges from 31 up to 120 dB μ V.

10.7.11 Smart Measure

The “Smart Measure” is a PMM 9010 unique feature, which allows a relevant time saving in Click measuring approach.

It is usually very difficult to measure QuasiPeak values for pulsed signals, in a way that linearity of the receiver could normally not fulfill such a special measurement's requirement.

PMM 9010 can trace and memorize eventual saturation, instead, just got during automatic measurement test procedure, in a way that, in case no saturation conditions at all have been detected, the so got test result can be used directly to soon calculate the new limit Lq, without the need of repeating the test for it (that is to say, making possible to skip Step 2, 4, 5 and 6).

At the end of a Smart Measurement, the operator can clearly define if the test has to be repeated with the new Lq Limit or if not repeating it at all in case of failure at this first step, so saving time and soon starting with further debugging of the EUT.

The operator can face then 3 different situations:

- “No Smart”, where such a function is not used at all;
- “Ask”, where a saturation is detected and the operator is asked to decide if continuing anyway or not;
- normal “Smart Measure”, where the measurement is normally performed until the end, i.e. the new Limit Lq is evaluated and the test is then performed taking such a new Limit into account.

10.8 Click option

The click option includes:

- Switching Operation Box;
- Power supply cable for the switching Box;
- EUT Power connector;
- Rewireable free socket;
- User Port cable, 2m;
- 20 dB external coaxial attenuator;
- Activation Code

For quick reference look at the following picture.



10.8.1 Optional PMM 9010 Click4E Four Channels Click meter

The description of the 9010 Click4E, Four Channels Click meter, is in Annex – C, included in this manual.

10.9 Test Set up

As required by the relevant standards, the discontinuous measurement (Click) test set up shall be the same adopted for continuous disturbances, therefore, usually, a LISN is used to sample the RF signal to be measured. In case the rate N is to be evaluated from the RF signal measurements, it needs only the connections between the receiver and the LISN (see § 2.11). When, instead, the click rate N shall be determined counting the number of “Switching” operations, a proper unit called “Switching Box” shall be connected to the User Port of the PMM 9010. In this case the EUT Power Connector will be used to feed the EUT through the Switching Box and the hardware connection scheme will become then:

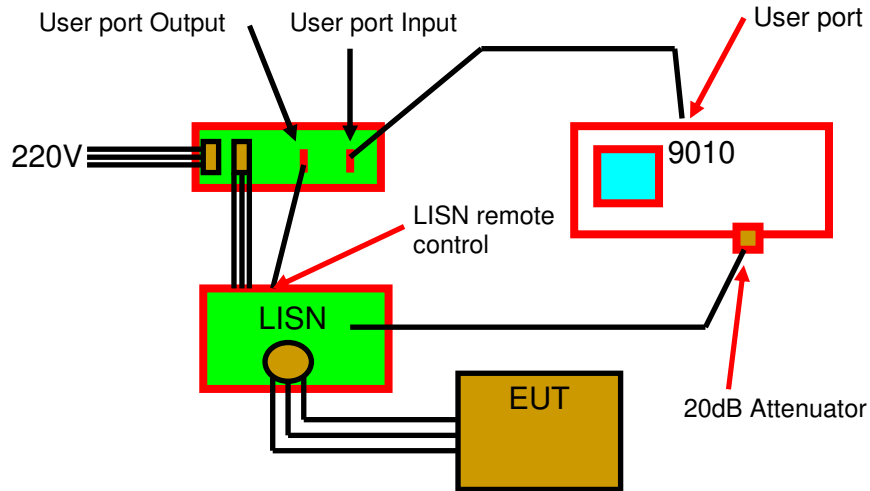

10.10 Diagnostic

In case the Switching Box unit is not connected – or anyway non properly functioning – the following message is displayed:

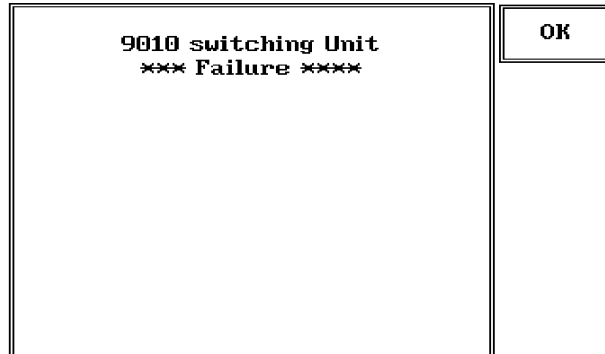

Three Leds are visible on the Switching Operation Box, with the following meaning:

TABLE 10-1 LED Status			
<i>ERROR</i> (Red)	<i>DATA</i> (Yellow)	<i>POWER ON</i> (Green)	<i>Meaning</i>
Blinking	Off	On	Condition at Power On, before attempting any access to the Box
Off	Off	On	Normal Condition after an access
Off	Blinking	On	Normal Usage with data transfer
On	Off	On	Error Condition (general)

In case of Error conditions, please check both HW connections and SW settings at first, then call closest NARDA representative for help.

10.11 Click reports with PMM Emission Suite

The PMM Emission suite supplied software provides an easy tool to download Click measurements from the analyzer.

Here is an example of what the Suite screen can show when a Click report has been downloaded.

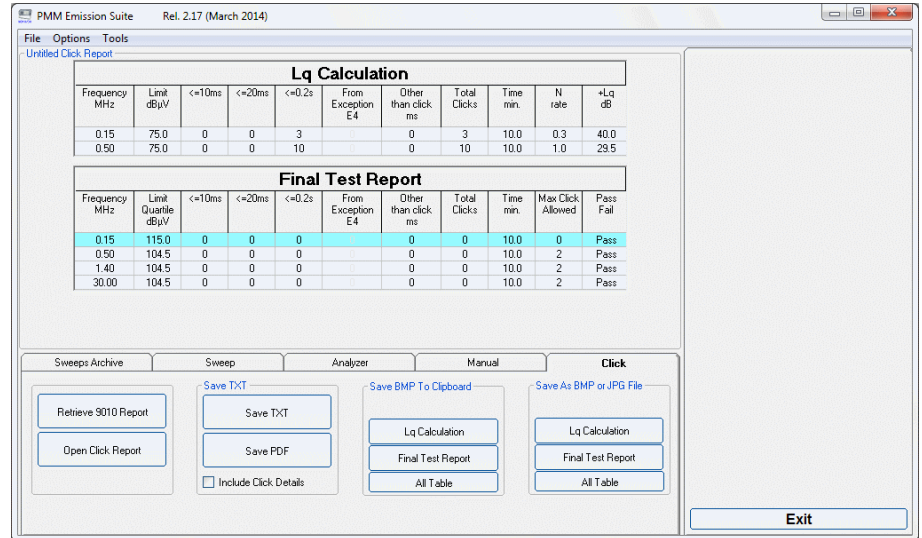

The screenshot shows the PMM Emission Suite software interface. At the top, it displays 'PMM Emission Suite Rel. 2.17 (March 2014)'. Below the menu bar, there are two tables: 'Lq Calculation' and 'Final Test Report'. The 'Lq Calculation' table has columns for Frequency (MHz), Limit (dBµV), and various time intervals (<=10ms, <=20ms, <=0.2s), along with 'From Exception E4', 'Other than clicks', 'Total Clicks', 'Time min.', 'N rate', and 'Lq dB'. The 'Final Test Report' table has columns for Frequency (MHz), Limit (dBµV), the same time intervals, 'From Exception E4', 'Other than clicks', 'Total Clicks', 'Time min.', 'Max Click Allowed', and 'Pass/Fail'. Below the tables, there are several buttons for file operations: 'Retrieve 9010 Report', 'Open Click Report', 'Save TXT', 'Save PDF', 'Include Click Details', 'Save BMP To Clipboard', 'Save As BMP or JPG File', and 'Exit'.



NOTE For further information about how to use the Click analyzer in conjunction with the provided Emission Suite, PC software, please refer to the PMM Emission Suite User's Manual.

This page has been left blank intentionally

11 – PMM 9030/9060/9180 EMI CISPR Receiver Extension, 30 MHz - 3/6/18 GHz (Option)



11.1 Introduction to PMM 9030/9060/9180

The PMM 9030/9060/9180 is a powerful EMI receiver, fully CISPR 16-1-1, which extends capabilities of PMM 9010 and 9010/03P/03P/30P/60P to measure conducted and radiated interferences from 30 MHz up to 3/6/18 GHz. All measurements performed by the PMM 9030/9060/9180 are according to the most accepted standards like: IEC, CISPR, EN (EuroNorm), FCC, VDE,

The PMM 9030/9060/9180 has been designed adopting an innovative philosophy made possible only in the recent years by the availability of superior technology components. This equipment is a combination of digital and analogue circuitries to realize a true EMI receiver and signal analyzer with the precision and accuracy of a numeric approach added to the flexibility and easiness of use of a modern instrument.

The PMM 9030/9060/9180 has been conceived as a “smart extension unit” of the PMM 9010 and PMM 9010/03P/30P/60P, to which the PMM 9030/9060/9180 shall be connected via high speed optic link.

11.2 Instrument Items

PMM 9030/9060/9180 include the following items:

- EMI receiver from 30 MHz up to 3/6/18 GHz;
- BP-02 Li-Ion battery pack;
- SPA-01 Plug-in AC Supply Adapter;
- AC/DC Converter with plug adapters;
- 20m Fiber Optic Cable;
- N male to BNC fem. Adapter;
- N male to N male adapter;
- Operating Manual (included in PMM 9010 Manual);
- Certificate of Compliance;
- Return for Repair Form.

11.3 Optional PMM accessories

PMM 9030/9060/9180 can be used with several optional accessories, the most common being the following:

- BC-01: Biconical Antenna (30 – 200 MHz)
- BL-01: Biconical Log Periodic Antenna 30 MHz to 6 GHz
- DR-01: Double-ridged Horn Antenna 6 to 18 GHz
- LP-02: Log Periodic Antenna 200 MHz to 3 GHz
- LP-03: Log Periodic Antenna 800 MHz to 6 GHz
- LP-04: Log Periodic Antenna 200 MHz to 6 GHz
- TR-01: Antenna Tripod
- Antenna Set AS-02 (BC01+LP02+TR01)
- Antenna Set AS-03 (BC01+LP02+LP03+TR01)
- Antenna Set AS-04 (BC01+LP04+TR01)
- Antenna Set AS-05 (BC01+LP04+DR01+TR01)
- Antenna Set AS-06 (BC01+LP02+LP03+DR01+TR01)
- Antenna Set AS-07 (BL01+TR01)
- Antenna Set AS-08 (BL01+DR01+TR01)
- AMK-01 Antenna Mounting Kit (for BC-01, LP-02, LP-03, LP-04, AS-02, AS-03, AS-04, AS-05 and AS-06)
- AMK-02 Antenna Mounting Kit (for BL-01, AS-07 and AS-08)
- VDH-01: Van der Hoofden Test Head 20 kHz to 10 MHz
- RF-300 : Van Veen Loop
- SB-600 : Automatic Slide Bar for radiated power tests

11.4 Other accessories

Of course, the PMM 9030/9060/9180 can be used with any other accessories available on the market, like:

- Antennas and loops, any type;
- Near Field Probes;
- Various TEM and GTEM Cells.

11.5 PMM 9030

Main Specifications

Table 11-1 lists the PMM 9030 performance specifications.

The following conditions apply to all specifications:

- thanks to its analogue+digital architecture, the PMM 9030 needs only 15 minutes of warm-up period before to operate in full-compliance with specifications;
- the ambient temperature shall be 0°C to 40°C

TABLE 11-1 PMM 9030 Main Specifications

Frequency range	30 MHz to 3 GHz (CISPR-16-1-1 Full-Compliance)		
Resolution	100 Hz		
Frequency Accuracy	< 2 ppm		
RF input	Z _{in} 50 Ω, N fem.		
VSWR			
≥ 10 dB RF att.	< 1,2; <2 over 1 GHz		
0 dB RF att.	< 2,0		
Attenuator	0 dB to 55 dB (5 dB steps)		
Preamplifier gain	10 dB (selectable)		
Max input level (without equipment damage)			
Sinewave AC voltage Pulse spectral density	137 dBuV (1 W)* 97 dBμV/MHz		
Preselector			
Three tracking filters;	30,0 MHz	to	96,6 MHz
	96,6 MHz	to	311,0 MHz
	311,0 MHz	to	1,0 GHz
One bandpass filter	1 GHz	to	3 GHz
IF bandwidth			
6 dB bandwidth	3, 10, 30, 100, 300 kHz, 1 MHz (Bimp)		
CISPR 16-1-1 bandwidth (6 dB)	120 kHz		

(*) with MIN ATT ≥ 10 dB

Noise level (Preselector ON) (Preamplifier OFF)	
30 to 300 MHz (120 kHz BW)	< 1 dB μ V (AV)
300 MHz to 3 GHz (120 kHz BW)	< 4 dB μ V (AV)
Noise level (Preamplifier ON)	
30 to 300 MHz (120 kHz BW)	< -5 dB μ V (AV)
300 MHz to 3 GHz (120 kHz BW)	< -2 dB μ V (AV)
Spurious response	< 10 dB μ V, < 15 dB μ V above 1 GHz
Measuring Detectors	Peak, Quasi-peak, Average, RMS, C-Avg, C-RMS, Smart Detector
Level meas. time	
Peak, Quasi-peak, RMS and Average (simultaneous detectors)	1 ms to 30 sec. (CISPR 16-1-1 default)
Display units	dBm, dB μ V (as stand-alone); dBm, dB μ V, dB μ V/m, dBmA, dBmA/m, dBpW (through 9010 SW Utility on PC)
Spectrum	
Span/division	Up to 300 MHz
Measurement accuracy S/N > 20 dB	
	30 to 1000 MHz \pm 1,0 dB 1 to 3 GHz \pm 1,5 dB
Demodulation	AM demodulator (through PMM 9010 and PMM 9010/03P/30P/60P)
I/O Interface Out	High Speed Optical Link; RS232 (service only)
Operating temperature	0° to 40°C
Power supply	10 - 15 Volt DC, 2,5A; Li-Ion rechargeable and interchangeable battery (4 h operations, average);
Dimensions	235 x 105 x 105 mm
Weight	2,0 kg

11.6 PMM 9030 Front and Rear Panel



Fig. 11-1 9030 Front and Rear Panels

Only the input N connector is available on the front panel.

All other interfaces and connections are on the rear panel.

Legend top-down, from left to right on the rear panel:

- **Replaceable Li-Ion Battery with Battery Charger connector**

- **OPTIC LINK** Optical link connector for PMM 9010 or PMM 9010/03P/30P/60P

- **RS232** 9 pin, DB9 connector

- **ON** Power ON-OFF switch button

- **PW** Power ON/Communication led (Blinking Red at power-on until communication with PMM 9010 or PMM 9010/03P/30P/60P is established, then Fixed Green during normal communication)

- **Product Label and Serial Number**

**11.7 PMM 9060
Main Specifications**

Table 11-2 lists the PMM 9060 performance specifications.
The following conditions apply to all specifications:

- thanks to its analogue+digital architecture, the PMM 9060 needs only 15 minutes of warm-up period before to operate in full-compliance with specifications;.
- the ambient temperature shall be 0°C to 40°C

TABLE 11-2 PMM 9060 Main Specifications

Frequency range	30 MHz to 6 GHz (CISPR-16-1-1 Full-Compliance)
Resolution	100 Hz
Frequency Accuracy	< 2 ppm
RF input	Z _{in} 50 Ω, N fem.
VSWR	
10 dB RF att.	< 1,2; <2 over 1 GHz;
0 dB RF att.	<2; <3 over 3 GHz
Attenuator	0 dB to 55 dB (5 dB steps)
Preamplifier gain	20 dB; 15dB above 1 GHz
Max input level (without equipment damage)	
Sinewave AC voltage	137 dBuV (1 W)*
Pulse spectral density	97 dBμV/MHz
Preselector	
Four tracking filters;	30,0 MHz to 72.0 MHz 72.0 MHz to 173,0 MHz 173,0 MHz to 416.0 MHz 416.0 MHz to 1 GHz
Two bandpass filter	1 GHz to 3 GHz 3 GHz to 6 GHz
IF bandwidth	
6 dB bandwidth	3, 10, 30, 100, 300 kHz, 1 MHz (Bimp)
CISPR 16-1-1 bandwidth (6 dB)	120 kHz

(*) with MIN ATT ≥ 10 dB

Noise level (Preselector ON)	
(Preamplifier OFF)	30 to 300 MHz < 5 dBuV (AV) (120 kHz BW) 300 to 1000 MHz < 7 dBuV (AV) (120 kHz BW) 1000 to 4000 MHz < 10 dBuV (AV) (120 kHz BW) 4000 to 6000 MHz < 14 dBuV (AV) (120 kHz BW)
(Preamplifier ON)	30 to 300 MHz < -11 dBuV (AV) (120 kHz BW) 300 to 1000 MHz < -6 dBuV (AV) (120 kHz BW) 1000 to 4000 MHz < -5 dBuV (AV) (120 kHz BW) 4000 to 6000 MHz < -1 dBuV (AV) (120 kHz BW)
Spurious response	< 10 dBuV, < 15 dBuV above 2 GHz,
Measuring Detectors	Peak, Quasi-peak, Average, RMS, C-Avg, C-RMS, Smart Detector
Level meas. time	
Peak, Quasi-peak, RMS and Average (simultaneous detectors)	1 ms to 30 sec. (CISPR 16-1-1 default)
Measurement accuracy S/N > 20 dB	30 to 1000 MHz ± 1.0 dB 1 to 3 GHz ± 1.5 dB 3 to 6 GHz ± 2.0 dB
I/O Interface Out	High Speed Optical Link; RS232 (service only)
Operating temperature	0° to 40°C
Power supply	10 - 15 Volt DC, 2,5A; Li-Ion rechargeable and interchangeable battery (4 h operations, average)
Dimensions	235 x 105 x 105 mm
Weight	2.2 kg

11.8 PMM 9060 Front and Rear Panel



Fig. 11-2 9060 Front and Rear Panels

Only the input N connector is available on the front panel.

All other interfaces and connections are on the rear panel.

Legend top-down, from left to right on the rear panel:

- Replaceable Li-Ion Battery with Battery Charger connector

- **OPTIC LINK** Optical link connector for PMM 9010 or PMM 9010/03P/30P/60P

- **RS232** 9 pin, DB9 connector

- **ON** Power ON-OFF switch button

- **PW** Power ON/Communication led (Blinking Red at power-on until communication with PMM 9010 or PMM 9010/03P/30P/60P is established, then Fixed Green during normal communication)

- Product Label and Serial Number

11.9 PMM 9180

Main Specifications

Table 11-3 lists the PMM 9180 performance specifications.

The following conditions apply to all specifications:

- thanks to its analogue+digital architecture, the PMM 9180 needs only 15 minutes of warm-up period before to operate in full-compliance with specifications;
- the ambient temperature shall be 0°C to 40°C

TABLE 11-3 PMM 9180 Main Specifications

Frequency range	6 GHz to 18 GHz (CISPR-16-1-1 Full-Compliance)		
Resolution	100 Hz		
Frequency Accuracy	< 2 ppm		
RF input	Z_{in} 50 Ω , N fem.		
VSWR			
10 dB RF att.	< 2		
0 dB RF att.	< 3		
Attenuator	0 dB to 45 dB (5 dB steps)		
Preamplifier gain	20 dB		
Max input level (without equipment damage)			
Sinewave AC voltage	137 dBuV (1 W)*		
Preselector			
Four bandpass filters	6 GHz to 9 GHz 9 GHz to 12 GHz 12 GHz to 15 GHz 15 GHz to 18 GHz		
IF bandwidth			
6 dB bandwidth	3, 10, 30, 100, 300 kHz		
CISPR 16-1-1 bandwidth (6 dB)	9, 120 kHz – 1 MHz		
Noise level (Preselector ON)			
(Preamplifier OFF)	6 to 18 GHz (1 MHz BW)	< 22 dBuV (AV)	(typ < 20 dBuV)
(Preamplifier ON)	6 to 18 GHz (10 kHz BW)	< -17 dBuV (AV)	(typ < -19 dBuV)
Spurious response	< 20 dBuV		
Measurement accuracy			
S/N > 20 dB	6 to 18 GHz	\pm 2.0 dB	

(*) with MIN ATT \geq 10 dB



I/O Interface Out	High Speed Optical Link; RS232 (service only)
Operating temperature	-5° to 45°C
Power supply	10 - 15 Volt DC, 2,5A; Li-Ion rechargeable and interchangeable battery (4 h operations, average)
Dimensions	235 x 105 x 105 mm
Weight	2.2 kg

11.10 PMM 9180 Front and Rear Panel



Fig. 11-3 9180 Front and Rear Panels

Only the input N connector is available on the front panel.

All other interfaces and connections are on the rear panel.

Legend top-down, from left to right on the rear panel:

- Replaceable Li-Ion Battery with Battery Charger connector

- **OPTIC LINK** Optical link connector for PMM 9010 or PMM 9010/03P/30P/60P
- **RS232** 9 pin, DB9 connector
- **ON** Power ON-OFF switch button
- **PW** Power ON/Communication led (Blinking Red at power-on until communication with PMM 9010 or PMM 9010/03P/30P/60P is established, then Fixed Green during normal communication)

- Product Label and Serial Number

11.11 Functional Description

The PMM 9030/9060/9180 feature a completely new receivers architecture based on the most recent DSP technology, as shown on the diagram below.
The PMM 9030/9060/9180 block diagram is shown in Fig. 11-3

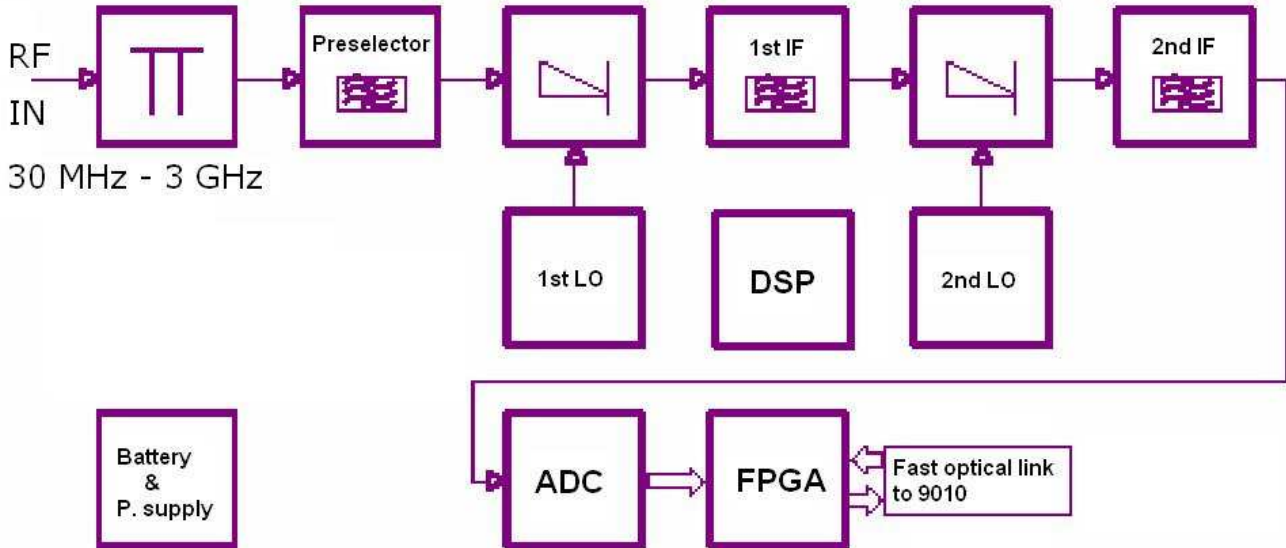

Fig. 11-4 PMM 9030/9060/9180 Functional BLOCK Diagram

11.12 No coaxial cable between the antenna and the receiver: a unique features of the PMM 9030/9060/9180

Thanks to its very limited dimensions and lightweight construction, the PMM 9030/9060/9180 can be connected directly to the antenna using the supplied antenna support/adaptor; the PMM 9030/9060/9180 is then linked to the PMM 9010 or PMM 9010/03P/30P/60P via the built-in high speed optical link. This is a very unique feature that makes the dream of all test engineers come true: no losses or mismatches between the antenna and the receiver, no more bulky cables full of ferrites, no more additional uncertainties due to the cables from the antenna to the receiver!
The Optical link, whose transfer rate is more than 2,5 Gb/s, and the proprietary transfer protocol help to ensure a communication almost error free and always reliable in all test measurement conditions.
A result of all these innovating features is that the PMM 9030/9060/9180 is extremely fast and a scan of the complete band up to 3/6/18 GHz can be performed in just 8 seconds: a terrific productivity increase in any test lab, in particular because these performances are obtained with no quality or performance compromises and with reduced uncertainties, compared to a traditional solution.



11.13 Emission measurements

All electric and electronic devices are potential generators of ElectroMagnetic Interference (EMI).

The term EMI thus refers to the electromagnetic energy emitted by a device which propagates itself along cables or through the air and couples with other devices that are present in the surroundings.

These electromagnetic fields (conducted or radiated interferences) may generate interfering currents and voltages into nearby equipment and therefore can cause possible malfunctions.

In order to prevent and control such interferences there are nowadays a number of national and international standards, like IEC and CISPR, which specifies limits and methods of tests. Moreover, within the European Union the application of several European Norms on Electromagnetic Compatibility is enforced by law and therefore the commercialization and use of all the electric and electronic equipment is subject to the measurement of the EMC characteristics, which must be within well defined limits.

The design approach adopted for the PMM 9030/9060/9180 is that the instrument shall be innovative, full compliant with all the relevant standards and at the same time simple and reliable to use, to be the base building block for any possible emission system to measure and evaluate any electric or electronic device from the very first design stages to the final certification.

The need to precisely measure the conducted and radiated EMI noises forces the equipment manufactures to use reliable equipment to verify the limits imposed by the relevant standards and/or enforced by local rules.

In this view the PMM 9030/9060/9180 receiver is the ideal solution from prototype debugging to final certification, as it fully meets all the performance criteria dictated by these standards, although it remains small, lightweight and very easy to use.

The PMM 9010 Utility control software permits an immediate use of the instrument without any training or special difficulties: the operator can concentrate just on analyzing the measurement results.

Moreover, the PMM 9010 software has also been designed for a fast and easy installation on any PC with the Windows™ operating system and with at least one free USB or Serial Port.

The device under test (DUT) must be installed according to the procedures indicated in the constructor's manual and normal operating conditions respected.



Be sure not to overload PMM 9030/9060/9180: the input signal should not exceed the maximum level indicated in the main specifications in chapter 11.

Also do not apply any signal to the 9010 or 9010/03P/30P/60P input and generator output connectors.

11.14 - Installation

11.14.1 Introduction

This section provides the information needed to install your PMM 9030/9060/9180. It includes the information pertinent to initial inspection and power requirements, connections, operating environment, instrument mounting, cleaning, storage and shipment.

11.14.2 Initial Inspection

When receiving the equipment, first inspect the shipping cardbox for any damages. If the shipping box is damaged, it should be kept until the contents of the shipment have been checked for completeness and the instrument has been checked mechanically and electrically.

11.14.2.1 Packing and Unpacking

Verify the availability of all the shipped items with reference to the shipping check list enclosed with the Operating Manual. Notify any damage to the forwarder personnel as well as to your NARDA Representative.



To avoid further damage, do not turn on the instrument when there are signs of shipping damage to any portion of it.

11.14.3 Preparation for Use



This is a Safety Class III apparatus, but it is also equipped with a protective/functional earth terminal on the rear panel. A good safety/functional ground connection should be provided before to operate the receiver.

11.14.4 Battery charger

The battery charger supplied with the receiver can work at either 50 Hz or 60 Hz with a supply voltage rated between 100 and 240 Volt. It is supplied with different connectors to fit all the possible outlets in accordance with the various National standards.



Battery charger: DC, 10 - 15 V, ~ 2500 mA
=> DC Connector

11.14.4.1 To replace the mains connector of the battery charger

To replace the mains connector, simply remove the one installed on the battery charger sliding it off, and insert the one that fits the outlets in use.

11.14.4.2 To charge the internal battery

In order to guarantee the best autonomy of the internal battery, we recommend to fully recharge it before using the receiver. To charge the battery, simply connect the battery charger to the mains power socket and insert the DC output connector of the battery charger to the input **CHARGER** on the rear panel of the receiver.

11.14.4.3 To supply the PMM 9030/9060/9180 through the mains power socket by SPA-01

To have an unlimited autonomy it is necessary to connect the PMM 9030/9060/9180 directly to the mains power socket using the supplied SPA-01 Plug-in AC Supply Adapter.

To install the SPA-01, simply slide BP-02 off and replace it with the SPA-01. Connect the battery charger to the mains power socket and insert the DC output connector of the battery charger to the input **10÷15 Vdc 2.5 A max** on the SPA-01.



11.14.4.4 Indication of the battery status on the screen and with PW led

The charge status of the battery is displayed at the right and on the middle of the PMM 9010 or PMM 9010/03P/30P/60P screen when initializing the PMM 9030/9060/9180. The symbol of a small battery will be filled up proportionally to the status of the battery charge.



When the battery is not under charge, the actual voltage value is displayed under the symbol and the length of the black bar filling the symbol indicates the available autonomy still remaining.



When the battery charger is connected to the PMM 9030/9060/9180 the indication "PWR" appears just below to the battery icon and the rear panel PW led becomes yellow if the receiver is switched on and red if the receiver is off.

The battery charging is suspended or ends automatically when one of the following events occurs:

- the full capacity of the battery has been achieved,
- the internal temperature of the battery is higher then a preset safety threshold,
- the charging time limit has been exceeded.



During recharging PMM 9030/9060/9180 should be left switched off.



It is also possible to charge the battery in a stand-alone mode. It's enough to connect the battery charger to the BP-02 rear panel connector and wait for the led located on the front panel to become green.

During the charging phase the led is red. If the Led is off, or blinks, it means something is going wrong; if this happens please check the battery charger, the mains socket and the connections.



The PW led on the back panel blinks green when the battery voltage drops below 7,0V to warn the Operator that the instrument is running out of battery.

To prevent any damage to the battery, the PMM 9030/9060/9180 automatically switches off when the battery voltage falls below 6,5V.



In order to keep the batteries fully functional, it is crucial to have a complete recharge before storing them for periods longer than 4 months. Therefore, it is suggested to recharge the batteries at least every 4 months even when the receiver has not been used.



The PMM 9010, PMM 9010/03P/30P/60P, and the PMM 9030/9060/9180 have the same model of battery. It means they are perfectly exchangeable among the equipment. To make an easy example, the 9010 or 9010/03P/30P/60P could be installed in an instrument/control room and connected to the mains, to keep the battery at its highest charge. The PMM 9030/9060/9180 could be in the test chamber – connected to 9010 or 9010/03P/30P/60P via fiber optic link - and running on its battery. When the battery of the 9030/9060/9180 is almost fully discharged, the User can stop the test, replace the battery of the 9030/9060/9180 with a charged battery (e.g. the one of 9010 or 9010/03P/30P/60P) and then restart the test.

11.14.9 Hardware Installation



PMM 9030/9060/9180 is delivered from factory ready to use as a companion of the PMM 9010 or 9010/03P/30P/60P.

To use PMM 9030/9060/9180 with PMM 9010 or PMM 9010/03P/30P/60P, please check your PMM 9010 or PMM 9010/03P/30P/60P is updated at the latest firmware version.

Remove the receiver from its cardboard and install it where desired, e.g. directly on the antenna output connector (see detailed instruction later on in this manual), or anyway connect the output of your antenna or transducer device to the N connector on the front panel of PMM 9030/9060/9180 and immediately start to measure up to 3/6/18 GHz.

Remove the Optic Link protective cover pressing the small tab under the protective cover and gently pull it; keep it aside for future protection of the port on the receiver. Repeat the same operations for the Optical Link #1 on the PMM 9010 or 9010/03P/30P/60P.

Connect the Optic Fiber delivered with PMM 9030/9060/9180 to the PMM 9030/9060/9180 and to the PMM 9010 or 9010/03P/30P/60P pushing the connector in the Optical port until a “click” can be heard; be sure the key of the connector is in the right orientation.

Once fiber optic cable has been connected properly on both sides it’s possible to start in operating PMM 9030/9060/9180 together with PMM 9010 or 9010/03P/30P/60P.



All the following examples are indifferently referred to the PMM 9010 or the PMM 9010/03P/30P/60P.

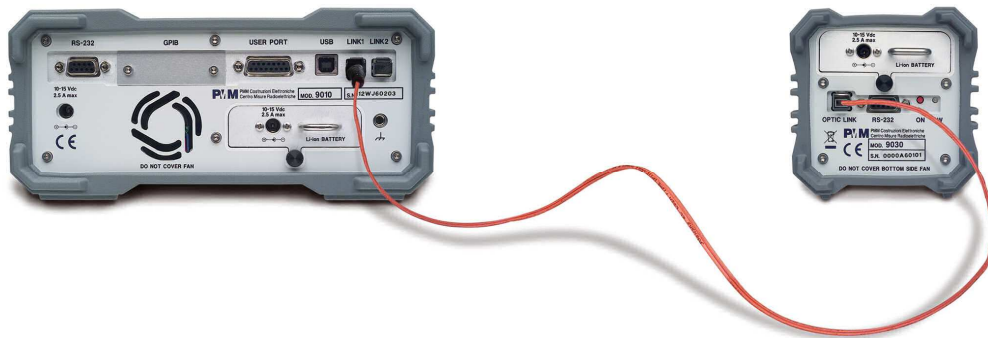

Fig. 11-5 PMM 9030/9060/9180 Fiber Optic Link to PMM 9010

Switch ON the PMM 9030/9060/9180 keeping the “ON” small red button pressed until the PW Led lights up blinking in Red colour (about 1 second), then release the button. To avoid unwanted starts, if the “ON” button is kept pressed for a too short time or for more then 2 seconds the instrument is switched automatically off.

Push and keep pressed the “ON/OFF” button for more then 2 seconds to switch off the receiver.

After having been switched ON, the PMM 9030/9060/9180 boots with its internal BIOS and in matter of few tens of second runs the firmware which manages the receiver.

Now switch ON the 9010 a screen like the following should appear.

11.14.10 PMM 9010 + PMM 9030/9060/9180 initial screen

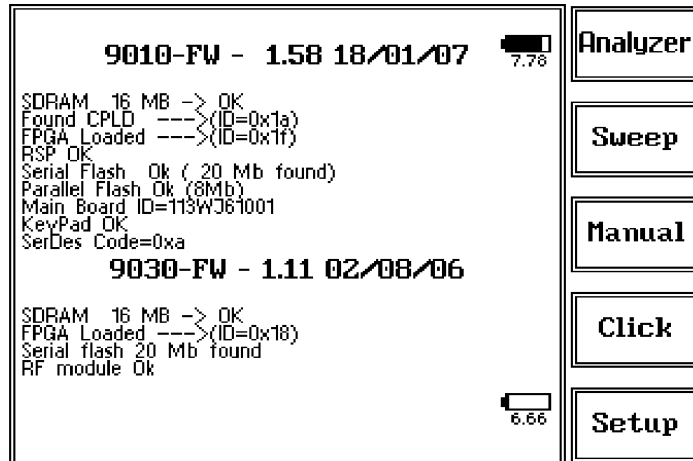

The PMM 9030/9060/9180 is now ready to work in conjunction with the PMM 9010.

11.14.11 LED on the PMM 9010 and on the PMM 9030/9060/9180

When the PMM 9030/9060/9180 is connected to PMM 9010, the yellow led next to the RF input of PMM 9010 ("0dB led") blinks to indicate that an expansion unit is connected and that this BNC input shall be kept free of any other connections.

The PW led on the back of the PMM 9030/9060/9180 remains on in fix green color, to indicate the connection is good and stable.

When for any reason the link between PMM 9010 and PMM 9030/9060/9180 is interrupted, the PW led on the PMM 9030/9060/9180 blinks red (as just after the power ON), to indicate there is a connection problem. After about 60 seconds in this condition, the PMM 9030/9060/9180 switches automatically OFF to save the battery.

11.14.12 PMM 9010 + PMM 9030/9060/9180 main screen

After having selected any key and being returned to the main screen, the usual appearance of the main screen is as follows:

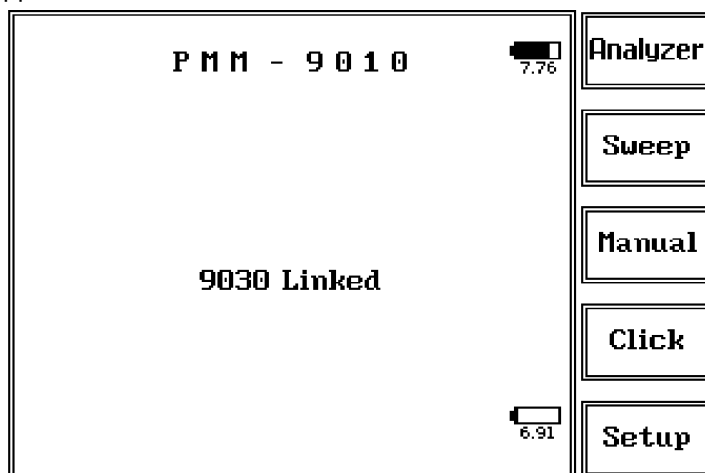

**11.14.13 PMM 9010 +
PMM 9030/9060/9180
Setup panel**

No changes in this panel, but that the Autocalibration function is no longer available in this condition.

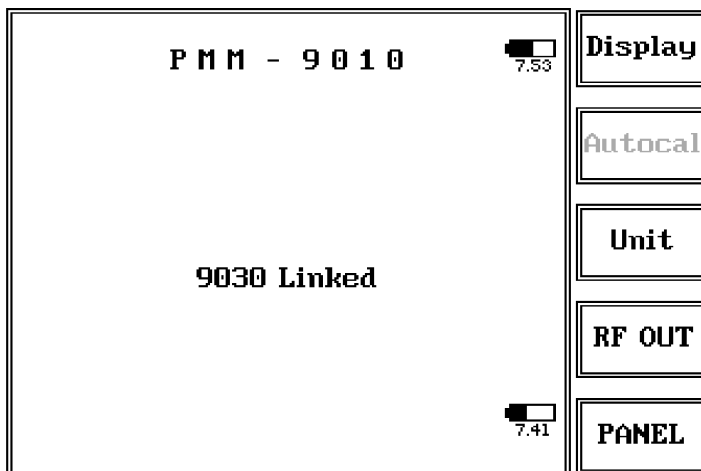

**11.14.14 PMM 9010 +
PMM 9030/9060/9180
Link failure**

When, for any reason, the optical connection between PMM 9010 and PMM 9030/9060/9180 is lost, a message is shown on the screen like the following:

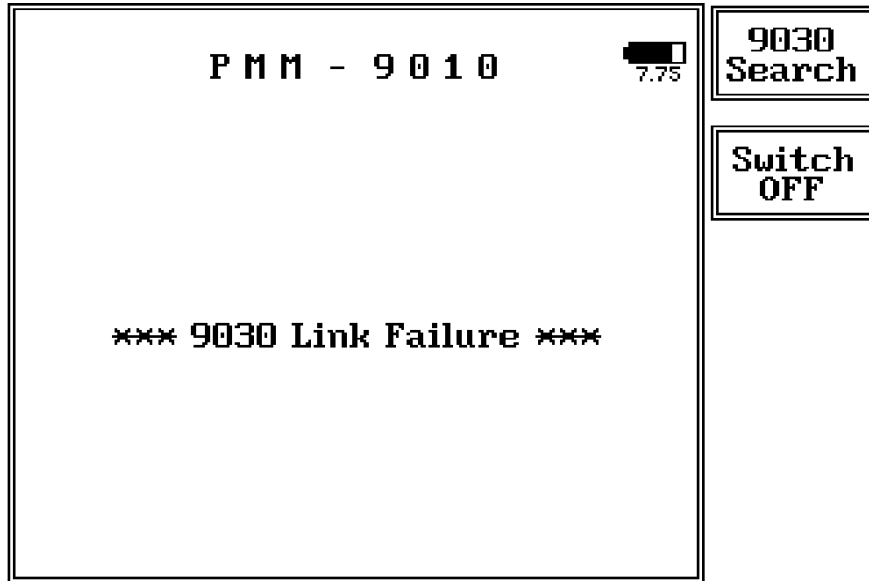

In this case, press the button 9030/9060/9180 Search: if there are no changes, check the PMM 9030/9060/9180 and verify it is ON. Replace the battery if needed (almost all the occurrences of link failure are due to the battery too low) and switch ON again the PMM 9030/9060/9180.

A new screen like the following should be displayed:

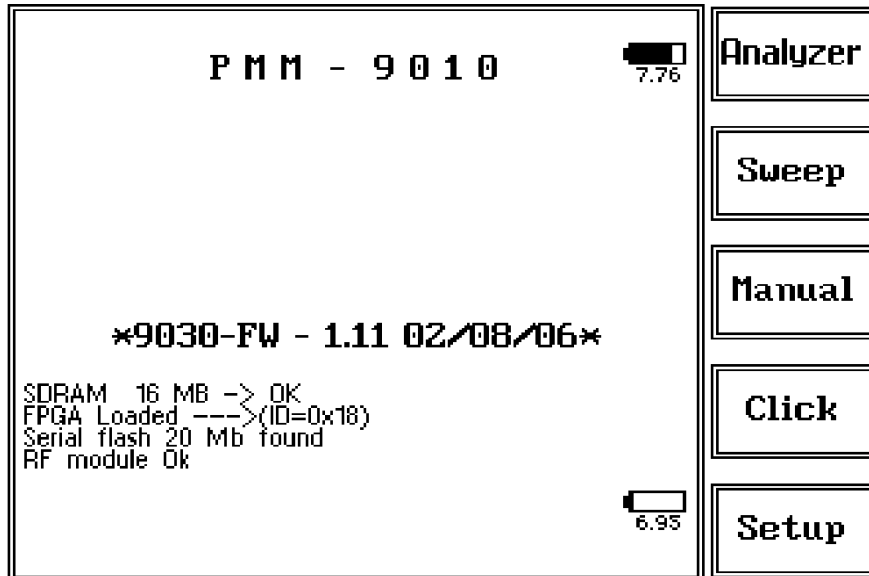

11.14.15 Antenna Mounting Kit AMK-01 and AMK-02 (optional)

In the frequency range from 9 kHz to 18 GHz a Loop, Rod, Biconic, Log-periodic and Horn antennas can be used to pick-up and measure RF radiated emissions. Alternatively, a versatile Biconic-Log antenna is also available to cover the full range 30 MHz to 6 GHz without changing antennas, even if such a solution is mostly more expensive and the antenna size is bigger.

The really “unique” feature of PMM 9030/9060/9180 is that of allowing direct connection between antenna output connector and EMI receiver input, so dramatically increasing system immunity to environmental noise at detection side and completely cutting-off any capacitive coupling between antenna, ground plane and connection cables.

In order to perfectly match antennas to PMM Receiver, two dedicated **Antenna Mounting Kit** are also provided as optional accessories, so balancing weight between receiver and antenna when attached to a tripod or antenna mast: **AMK-01** (for BC-01, LP-02, LP-03 and LP-04) and **AMK-02** (for BL-01).

Such Antenna holder comes with some spare parts plus nuts and bolts, which can be easily assembled with provided wrench, as per step-by-step operations in following pictures.

AMK-01 Antenna Mounting Kit with BC-01, LP-02 and LP-04

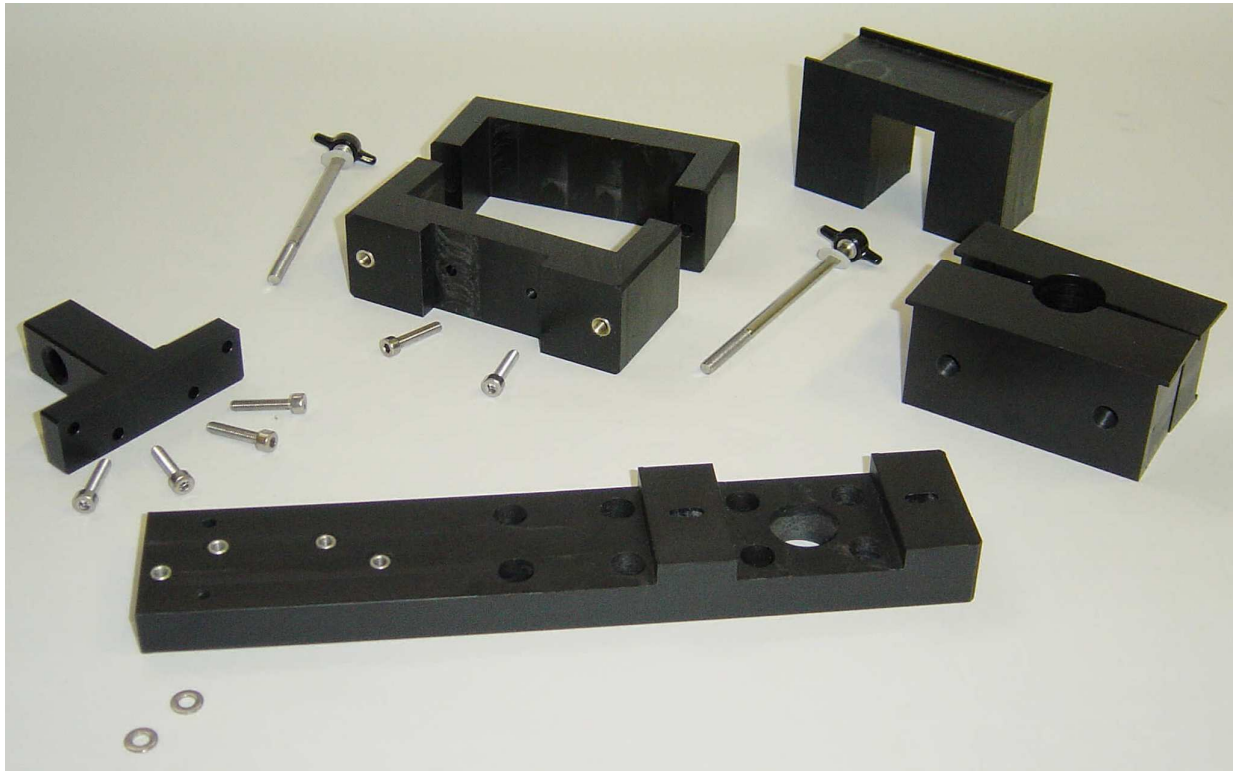
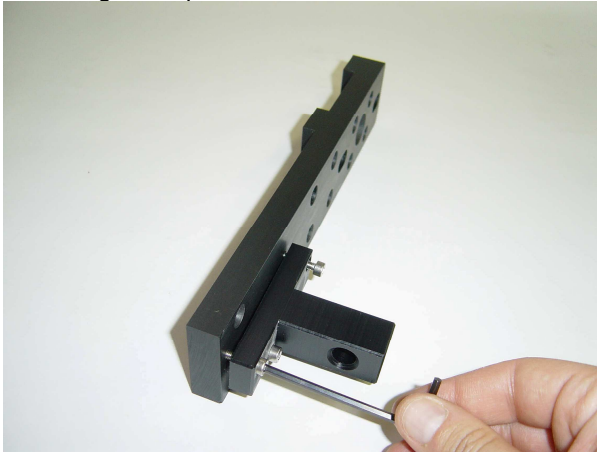

Fig. 11-6 AMK-01 Antenna Mounting Kit

 **NOTE**

For information on BC-01, LP-02 and LP-04 mounting, please refer to the Antenna Set user’s manual.

Mounting the tripod Joint



Fixing the base of Antenna holder

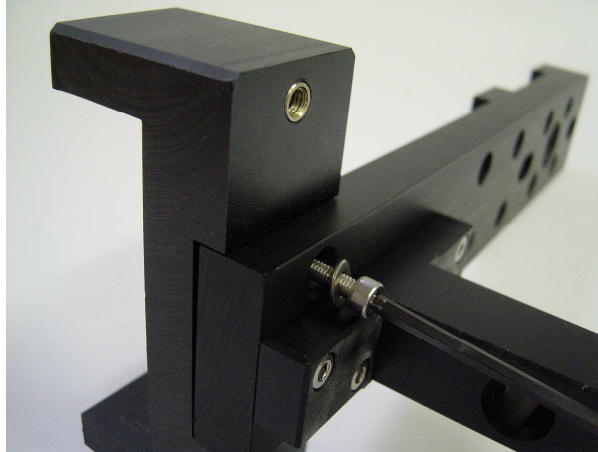
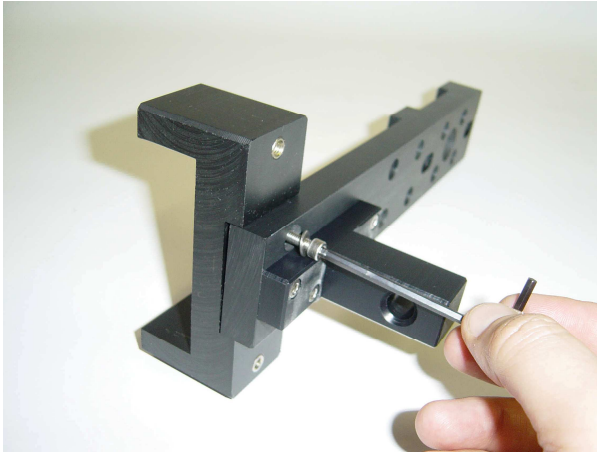

Closing the Antenna Holder and insert the Adapter for PMM Log-Periodic

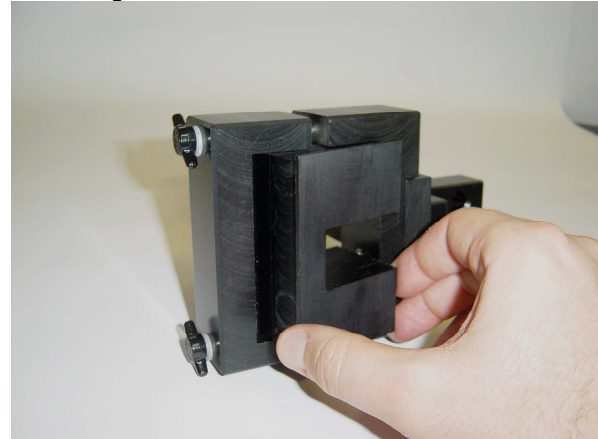
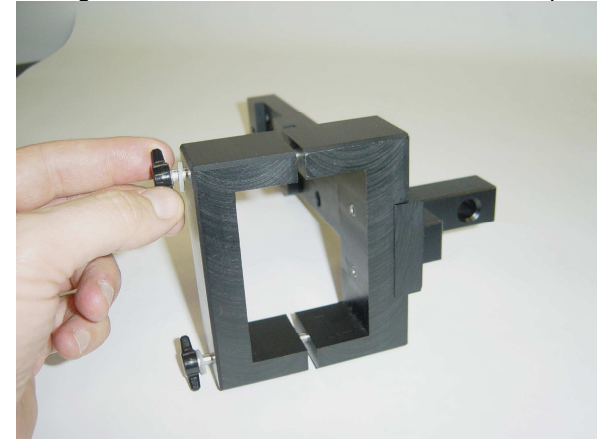

Complete assembling

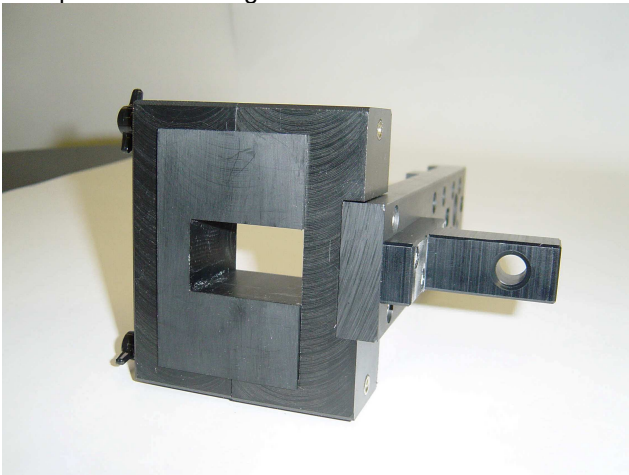

Complete assembling for other antennas

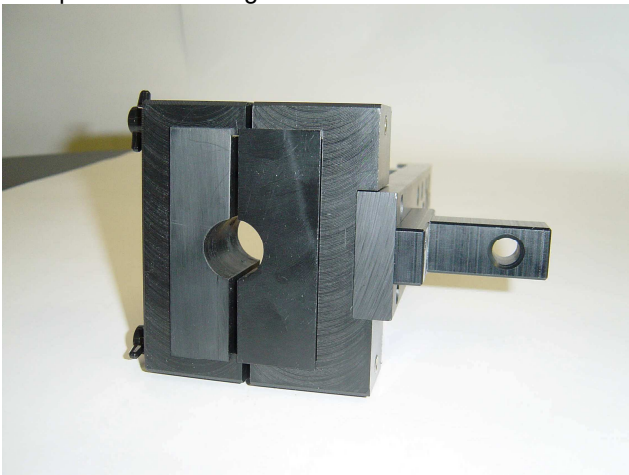

Mounting the PMM 9030/9060/9180 on the Antenna Holder

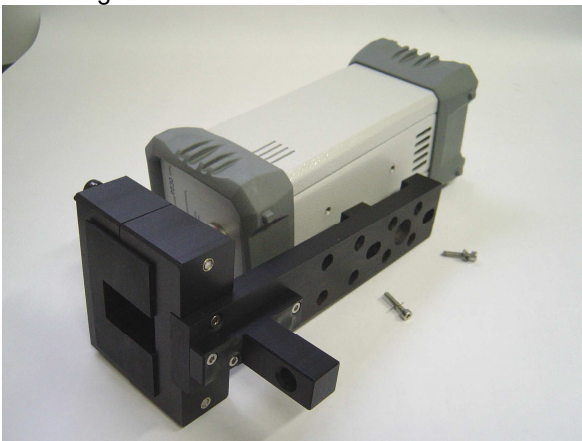

Screwing the N-N Adapter for Antenna Matching

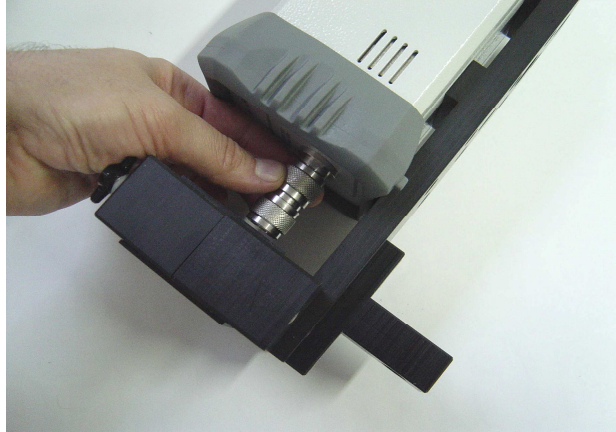
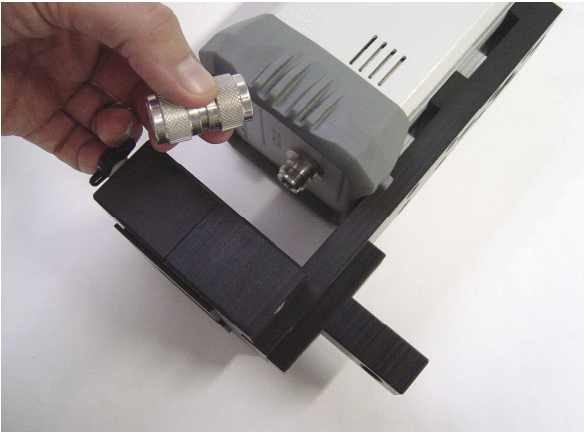

Fixing onto the TR-01 by Tripod Joint

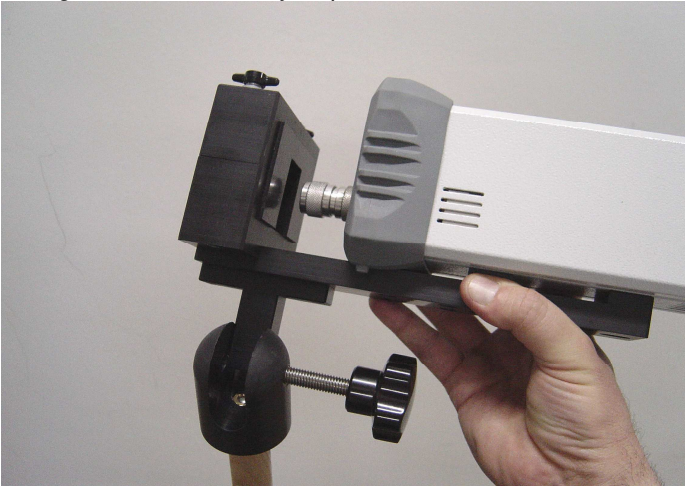

Attaching PMM Log-Periodic



**AMK-01 Antenna
Mounting Kit with LP-03**

 **NOTE**

For further information on LP-03, please refer to the Antenna Set user's manual.

Mounting the Tripod joint

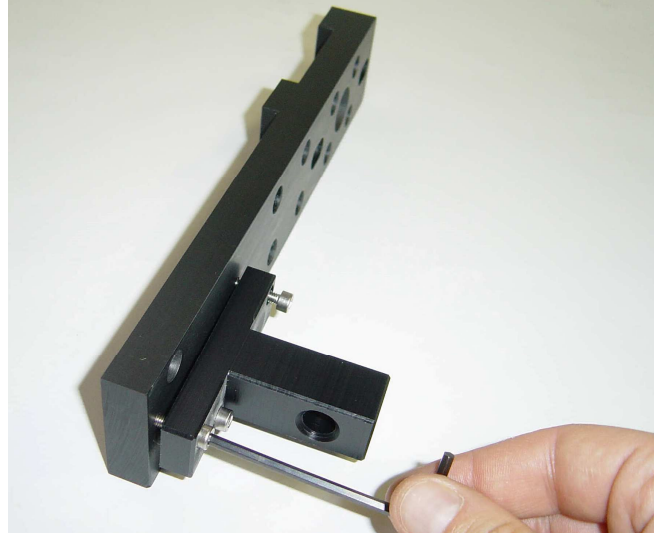

Mounting the Antenna Holder on PMM 9060



Fixing onto the Tripod

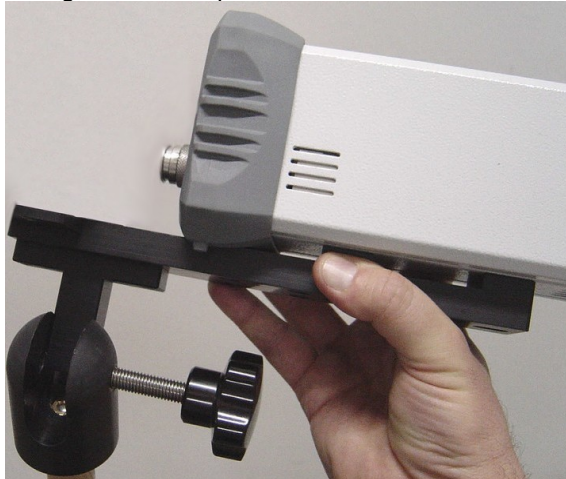

Attaching PMM LP-03 Log Periodic



Change the PMM 9060 polarization from horizontal to vertical or vice versa and tighten the knob completely.



**AMK-02 Antenna
Mounting Kit for BL-01**



Fig. 11-7 AMK-02 Antenna Mounting Kit

Assembly the Antenna holder screwing the socket-head screw with Allen key 4mm (without closing completely).



 **NOTE**

For further information on BL-01 mounting, please refer to the Antenna Set operation manual.

Position the BL-01 antenna on the ground as shown in the picture below.



Insert the Antenna holder on the BL-01 cover



Insert the Support base between the Antenna holder and BL-01 cover



The Support base must be adherent to the BL-01 cover and positioned as shown on the picture below



Move and position the Antenna holder on the machined surface (be sure it is fully inserted).

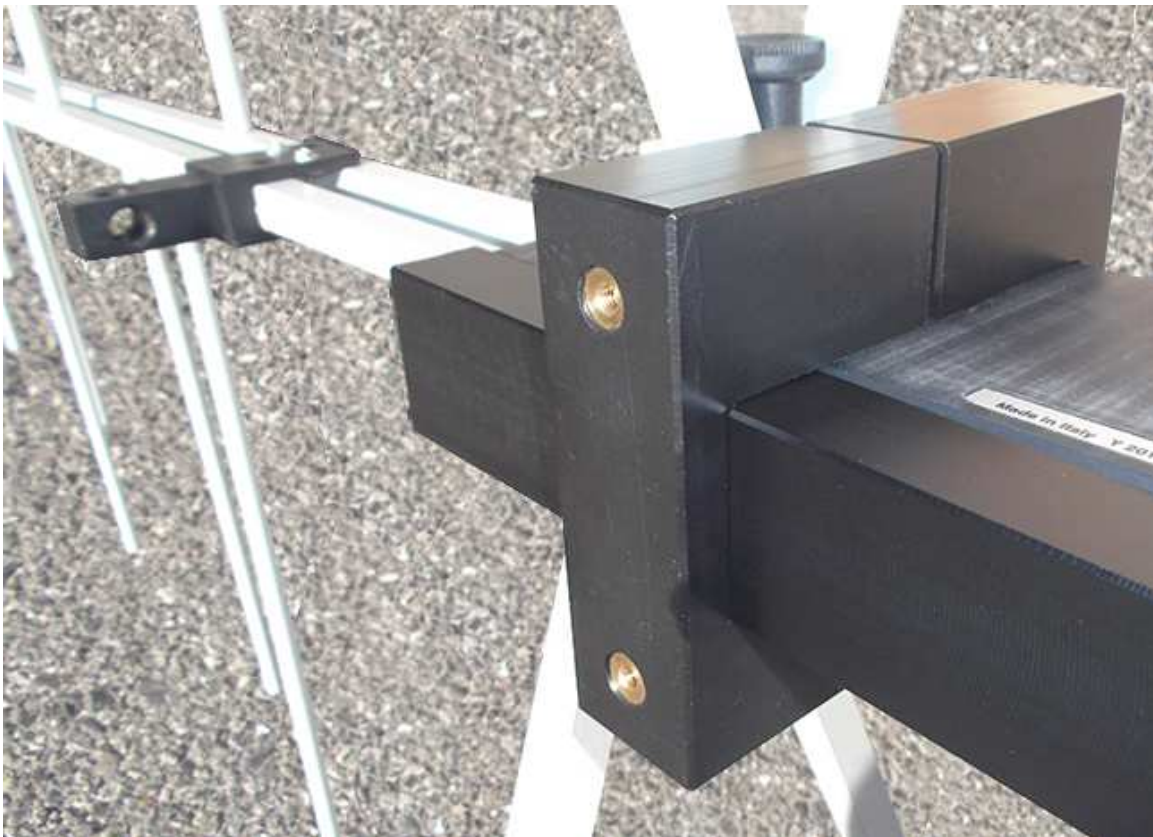

Close the Antenna holder screwing the socket-head screw with Allen key 4mm



Insert the second Antenna holder on the BL-01 cover



Move and position the second Antenna holder on the machined surface (be sure it is fully inserted).

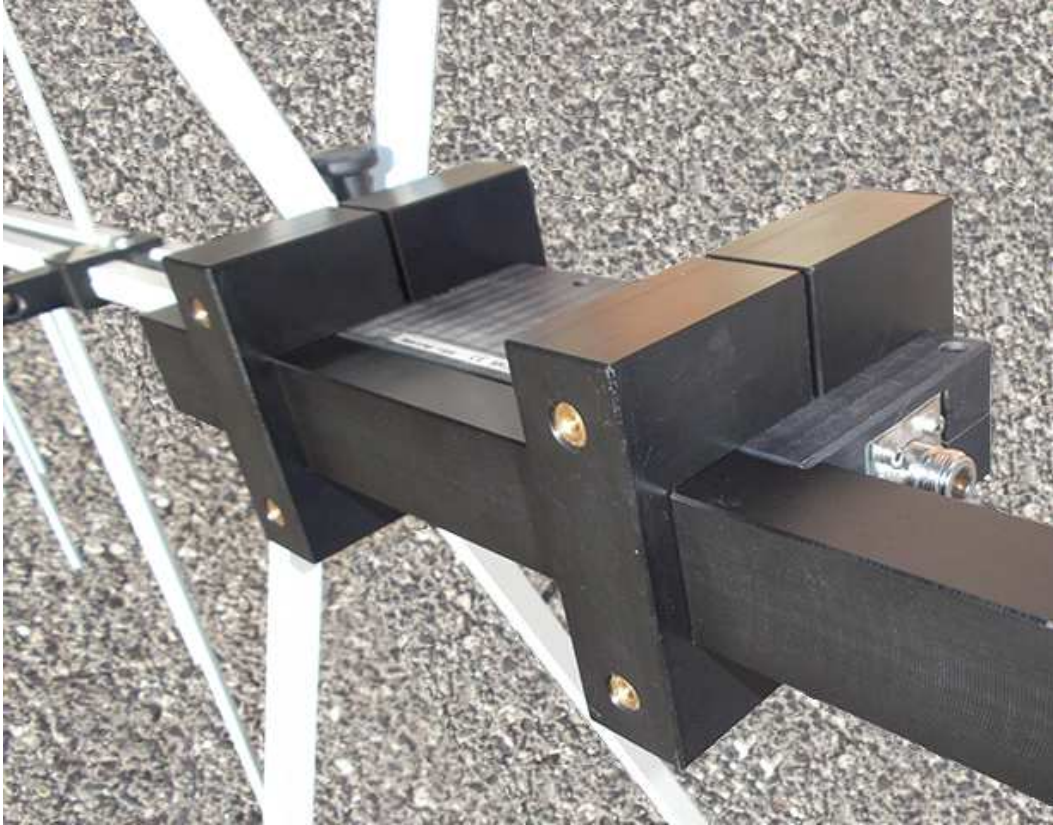

Close the Antenna holder screwing the socket-head screw with Allen key 4mm



Screwing the N-N Adapter to BL-01 connector



Screwing the N-N Adapter to PMM 9060; the Receiver must be adherent to the support base and positioned as shown on the picture below



Fix the PMM 9060 to the support base screwing the socket-head screw (and flat washer) with Allen key 3mm



Unscrew the knob from the TR-01 adjustable joint.



Insert the BL-01 tripod joint on the TR-01 adjustable joint.



Change the antenna polarization from horizontal to vertical or vice versa and tighten the knob completely.



11.15 - Analyzer Mode Operating Instructions

11.15.1 Introduction



To enter in the **ANALYZER Mode** it's enough to depress the Analyzer soft key on the main screen.

In this mode the receiver works as a powerful Spectrum Analyzer and the display shows the "spectrum analysis" (span max 3/6/18 GHz) in the frequency domain of a signal tuned at a given frequency.

The analysis is done at the selected span frequency.

Using the marker facility the User can accomplish a very accurate measurement of the signals either in frequency as well as in level.

Entering **Analyzer Mode** from the main menu, the display will look like the following:

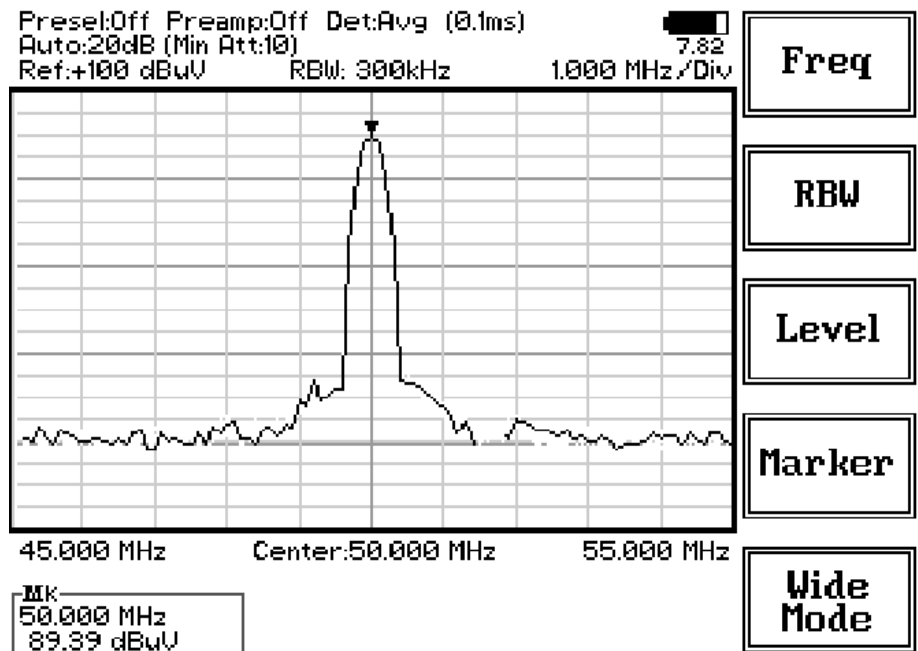

Fig. 11-8 Spectrum



The SPAN per division is automatically managed by the equipment.

On the screen of the Analyzer Mode all the relevant information are reported. From the upper left corner, the User can see if the Preselector is ON or OFF; if the Preamplifier is ON or OFF; which detector is in use and the relevant hold time; if the input attenuation is Automatic or Manual and the set attenuation and if the Minimum attenuation is 10 dB or 0dB.

Just above the graph, from left to right, there is the Reference level, the Resolution bandwidth and the span value.

Below the graph the start, center and stop frequency.

The bottom left corner is dedicated to the marker indication, with actual frequency and level of the marker.



The Spectrum mode function is divided into five sub windows:

- Frequency
- Resolution Bandwidth
- Level
- Marker
- Wide Mode

The fifth button is used to change the spectrum view to **wide screen mode**, as shown in the picture 4-1, and with the **Esc** button the original view can be restored.

Always use Esc button to return to the previous view/condition.

11.15.2 Frequency

Allows the User to set the tuning frequency and also the Span.



The **Center** frequency of the Spectrum window can be directly edited into the window or set by the arrow buttons or by the rotary knob, which frequency steps are set under the Manual mode.

Depressing the **Center** button the figures 0, 1, 2, 3, and 4 are selectable; with the right arrow key it is possible to select the figures from 5 to 9, and pressing again the right arrow key the units kHz, MHz and GHz becomes accessible, as well as the decimal dot and the Back Space. The left arrow key can be used as well to move back and forth from one screen to the other. Pressing 0 as the first figure the decimal dot appears automatically.

To set a given frequency it is therefore enough to edit the value with the soft keys and the left an right arrows, confirming the selections entering the units value (kHz, MHz or GHz).

The figures entered appear in a small window just below the graph and the default unit is MHz, so 100 kHz = 0,1 MHz; 10 kHz = 0,01 MHz; 1 kHz = 0,001 MHz and 100 Hz = 0,0001 MHz.

Using the **Start** and **Stop** buttons it is possible to select any start and stop value in the frequency range 10 Hz to 3/6/18 GHz band.

Another method for setting the frequency is to enter the **Center** frequency and the appropriate **Span**.

In this mode of operation the frequency step (spectrum resolution) is set automatically, therefore it cannot be changed manually.

11.15.3 RBW

The **Resolution Bandwidth** command is used to select the bandwidth of the measuring filter. Seven bandwidth filters, shaped at -6dB, are available:

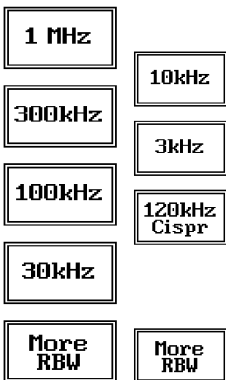

- 120 kHz CISPR 16
- 3 kHz
- 10 kHz
- 30 kHz
- 100 kHz
- 300 kHz
- 1 MHz (Bimp)

The four larger filters are selectable from the first RBW screen, and pressing the **More RBW** button it is possible to select all the other filters.

These filters are mathematically modeled using FIR (Finite Impulse Response) technique and they are exactly as required by the standards.

More filters will be available as an option for specific applications, e.g. to cover Military Standards requirements, etc.



11.15.4 Level

The Level function has 5 sub-menus, each one with several options.



Pressing the **Display** button it is possible to set two parameters: the visualized **Dynamic** range (chosen between 80, 100 and 120dB) and the **Reference Level**, that can be increased or reduced by steps of 5dB within the range +55 dB μ V to 90 dB μ V (-50 to - 15 dBm).

The **Input** button opens a submenu which is dedicated to the setting of the input attenuator and to switch on-off the built-in preamplifier.

The PMM 9030/9060/9180 receiver takes automatically into account the settings of all the Input parameters and always displays the correct value of the level. The User is not required to make any correction to the readings.

11.15.4.1 Input: Attenuators and preamplifier

Being entered in the Input submenu, to increase or decrease the attenuation at the input, press **Att +** or **Att -**, and for each touch the attenuation is increased or decreased of 5 dB (preset value) up to the max attenuation available of 55 dB.

Depressing either one of these keys force the receiver in manual attenuation.



The **Min Att** button acts as a toggle switch: it selects or deselects the minimum attenuation of 10 dB. When the minimum attenuation is selected, the attenuator – doesn't matter if in automatic or in manual condition - cannot be lowered under 10 dB.

Unless specifically required by the test conditions, do not remove the minimum attenuation of 10 dB.

With the **Preamp** key it is possible to insert or exclude the built-in low noise preamplification of 10 dB.

The internal 10 dB preamplifier can be used when very weak signals have to be investigated. As already mentioned, with the preamplifier ON the receiver takes automatically care of the 10 dB gain when measuring the signals.

The **Att Auto** button is used to switch from the two conditions of manual or automatic attenuation setting.

Please note that the switching of the attenuators is relatively noisy and you can perceive it distinctly with a "click" for each switch operation.

Using 0 dB attenuation PMM 9030/9060/9180 has no input protection. This is a potentially dangerous condition for the input stage of the receiver.



Use 0 dB attenuation only if you are very sure that your input signal is less than 1 V (or 120 dB μ V).

Before to apply an unknown signal to PMM 9030/9060/9180 receiver, use an oscilloscope or a wide band RF voltmeter to measure it. In any case set Min. ATT at 10 dB and select the maximum available attenuation with preamplifier OFF.

If needed, add an external coaxial attenuator on the input signal line.

11.15.4.2 Misc



Under the **Miscellanea** functions menu it is possible to activate or exclude the **Preselector** filters and also to set the **Tracking Generator**.

The **Preselector** is composed by a group of filters automatically selected by the PMM 9030/9060/9180 while it is sweeping or anyway measuring. The aim of the preselector is to reduce the amount of out-of-band energy entering in the receiver, thus helping a lot in reducing intermodulation problems and similar undesired behaviors.

In Analyzer mode the preselector is available only if the entire span falls in one filter band (see the main specification in chapter 1 to verify the frequency bands). In this situation on the display it will be shown: Preselector ON. If the span is larger than one filter only, on the display the symbol *** will appear instead.

It can be set either ON or OFF with the associated button, and normally it should be always enabled.

On the top left corner of the screen the symbol “Off” or “On” will be displayed.

Pressing the **RF OUT** button the receiver enters the Generator menu.

11.15.4.3 Detector



This menu allows the Operator to select the most appropriate detector for the test.

In Analyzer mode the Peak, Average and RMS (Root Mean Square) detectors are available and can be selected via the appropriate button.

Hold time

The Hold Time (expressed in milliseconds) represents the time the receiver uses to “take a snapshot” of the incoming signal and to measure it with the chosen detector. When selecting a detector, the default hold time value is automatically loaded, but in some cases this time is not appropriate, e.g. when the interference signals have a low repetition rate. In this case the PMM 9030/9060/9180 sees a high input signal and therefore tries to set the proper attenuation automatically increasing the value or the input attenuators. However, when the input attenuation is set the signal is gone, so the receiver lowers the attenuation, but then a new peak arrives, and so on and so forth..

On the other hand, if the Hold Time is too high the PMM 9030/9060/9180 cannot properly follow the signals.

In this situation the Hold Time value should be manually set to find a correct compromise.

To set the Hold Time to the lowest possible value (this value dynamically depends from the measurement conditions), enter the figure 0; if a value lower than the allowed is entered, the lowest possible value is automatically selected.

The max. Hold Time that can be set is 30 sec (30.000 ms).



11.15.4.4 Conversion factor



When using a transducer to make a measurement – a Voltage or Current Probe, an Antenna, etc. – there is always the need to add to the measured values the conversion factor of the transducer in use. The Conversion factor may also take proper account of losses as cable loss, attenuators added externally to the receiver, etc. The PMM 9030/9060/9180 can handle these factors in an automatic way and directly correct the readings.

The PMM 9030/9060/9180 can store in its internal non-volatile memory up to 4 different correction factors, and use them one at a time when recalled. However, the **Conversion Factors** shall be created and loaded via the PMM 9010 Software Utility.

Press the relevant button to load the conversion factor, and **NONE** to unload it.

11.15.5 Marker



With this command the **Marker** function can be enabled.

Switching ON the marker it appears on the screen as a small black pointing down arrow, and simultaneously a small window shows up in the bottom left corner of the screen, indicating the actual frequency and level read by the marker.

Pressing the **Peak** button the marker will automatically move to the highest signal found in the span range in that given moment, and with the help of the **Center** button the frequency selected by the marker becomes the center frequency on the screen, making very easy any signal analysis.

11.15.6 ESC

This button allows to return to the previous view or condition.

11.16 - Sweep Mode Operating Instructions

11.16.1 Introduction

Sweep

The **Sweep mode** is used to operate the PMM 9030/9060/9180 as a powerful scanning receiver. To enter in this mode it's enough to depress the Sweep soft key on the main screen, and immediately the scan setup window pops up and allows the operator to set the parameters for the scan.

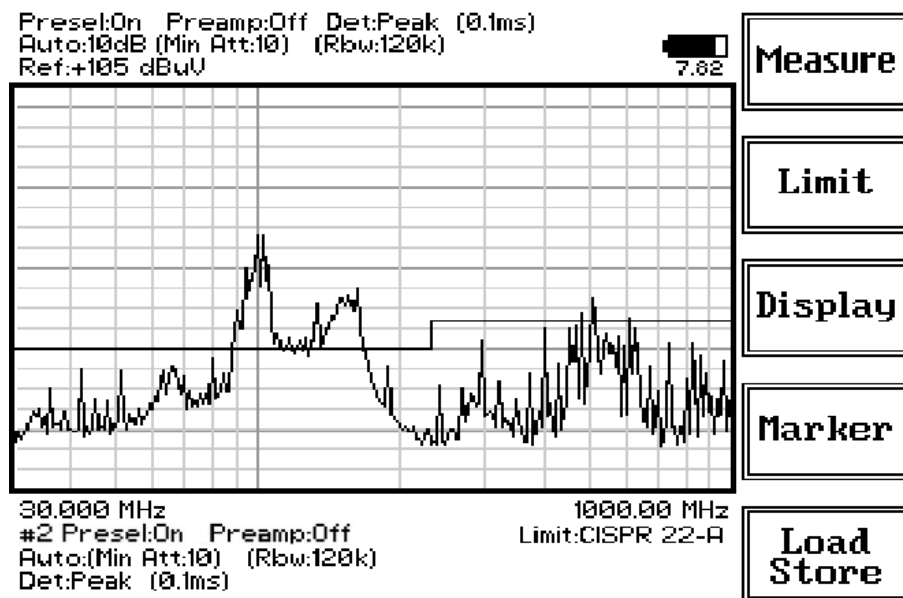

Fig. 11-9 Sweep

As for the Analyzer operating mode, all the relevant information are reported on the screen.

From the upper left corner, the User can see if the Preselector is ON or OFF; if the Preamplifier is ON or OFF; which detector is in use and the relevant hold time; if the function "Smart Detector" is activate and which one; if the input attenuation is Automatic or Manual and the set attenuation and if the Minimum attenuation is 10 dB or 0dB.

Just above the graph there is on the left the Reference level. During the scan, in the center above the graph the actual frequency measured and/or any other relevant operation.

Below the graph the start and the stop frequency, and loaded limits, if any.

When the sweep has been executed, on the bottom of the screen the most important sweep parameters are repeated.

If the graph has been loaded from the memory, just below the start frequency there is the symbol # followed by the memory position loaded (position number 2 in figure 11-18).

Please note that the information in the upper part above the graph refers to the next sweep to be done, while the information in the lower part, below the graph, concerns to the actual displayed data.



Measure

Limit

Display

Marker

Load Store

The Sweep mode function is divided into five sub windows:

- Measure
- Limit
- Display
- Marker
- Load Store

Always use Esc button to return to the previous view/condition.

11.16.2 Measure

Exec Sweep

Freq

Level

Conv Factor

Re Do Sweep

The **Measure** button is used to set the scan parameters and to run the sweep.

After having chosen the frequency band and set all the other parameters it is possible to run the measurement scan simply touching the **Exec Sweep** button.

To make subsequent sweeps with the same setting parameters, simply press **ReDo Sweep**. This key is particularly useful after having loaded a previously stored track (see 11.12.6), as with the Re Do Sweep the original settings are kept for the new measurement: it is extremely easy to make comparisons, for example, before and after a modification of the EUT.

Once the scan starts, it can be stopped at any time during the execution by the **Stop** function key that appears during the scan.

11.16.2.1 Frequency

C + D Band

E Band

C+D+E Band

Adv..ed

The **Frequency** menu features four function buttons:

With the **C+D Band** the receiver will be set to work in the 30 – 1000 MHz range. The definition of bands C (30-300 MHz) and D (300-1000 MHz) is a given in CISPR 16-1-1.

Pressing **E Band** the receiver will be set to scan the 1 – 3/6/18 GHz frequency band. The definition of band E (1-18 GHz) is a given in CISPR 16-1-1.

Pressing **C+D+E Band** the receiver will be set to scan the entire band from 30 MHz to 3/6/18 GHz.

Using these automatic band settings, the Frequency Step and Resolution Bandwidth are set automatically according to CISPR standard requirement.

For the Advanced option please see next paragraph.

Please note that to make effective the changes after having selected a band, the receiver needs to start its sweep.

11.16.2.2 Advanced



The **Advanced** submenu features five function buttons:

RBW Auto automatically adjust the resolution bandwidth to selected frequency range as per the CISPR standards.

The User can also decide which resolution bandwidth use simply selecting either one of the 2 bands available: **120 kHz** or **1 MHz**.

The **Start** and **Stop** frequency buttons can be used to set any frequency interval for the measurement; to enter the frequency values press the corresponding function keys.

Pressing either one of these 2 keys the figures 0, 1, 2, 3, and 4 are selectable at first; with the right arrow key it is possible to select the figures from 5 to 9, and pressing again the right arrow key the units kHz, MHz and GHz becomes accessible, as well as the decimal dot and the Back Space. The left arrow key can be used as well to move back and forth from one screen to the other. Pressing 0 as the first figure the decimal dot appears automatically.

To set a given frequency it is therefore enough to edit the value with the soft keys and the left an right arrows, confirming the selections entering the units value (kHz, MHz or GHz).

The figures entered appear in a small window just below the graph and the default unit is MHz.

11.16.2.3 Level



The Level function has 4 sub-menus, each one with several options..

Pressing the **Display** button it is possible to set two parameters: the visualized **Dynamic** range (chosen between 80, 100 and 120dB) and the **Reference Level**, that can be increased or reduced by steps of 5dB within the range +55 dBμV to 90 dBμV (-50 to - 15 dBm).

The **Input** button opens a submenu which is dedicated to the setting of the input attenuator and to switch on-off the built-in preamplifier.

The PMM 9030/9060/9180 receiver takes automatically into account the settings of all the **Input** parameters and always displays the correct value of the level. The User is not required to make any correction to the readings.

With the PMM 9030/9060/9180 the function **Smart Detector** is not available.

Using 0 dB attenuation PMM 9030/9060/9180 has no input protection. This is a potentially dangerous condition for the input stage of the receiver.



Use 0 dB attenuation only if you are very sure that your input signal is less than 1 V (or 120 dBμV).

Before to apply an unknown signal to PMM 9030/9060/9180 receiver, use an oscilloscope or a wide band RF voltmeter to measure it. In any case set Min. ATT at 10 dB and select the maximum available attenuation with preamplifier OFF.

If needed, add an external coaxial attenuator on the input signal line.



In case an OVERLOAD indication occurs it is necessary to add an external attenuator to carry on the measurement without overpassing the declared limit for continuous power or spectral density.

11.16.2.3.1 Input: Attenuators and preamplifier



Being entered in the Input submenu, to increase or decrease the attenuation at the input, press **Att +** or **Att -**, and for each touch the attenuation is increased or decreased of 5 dB (preset value) up to the max attenuation available of 55 dB.
 Depressing either one of these keys force the receiver in manual attenuation.

The **Min Att** button acts as a toggle switch: it selects or deselects the minimum attenuation of 10 dB. When the minimum attenuation is selected, the attenuator – doesn't matter if in automatic or in manual condition - cannot be lowered under 10 dB.

Unless specifically required by the test conditions, do not remove the minimum attenuation of 10 dB.

With the **Preamp** key it is possible to insert or exclude the built-in low noise preamplification of 10 dB.
 The internal 10 dB preamplifier can be used when very weak signals have to be investigated. As already mentioned, with the preamplifier ON the receiver takes automatically care of the 10 dB gain when measuring the signals.
 The Preamplifier must be mandatory switched off (default) while carrying on CISPR measurements.

The **Att Auto** button is used to switch from the two conditions of manual or automatic attenuation setting.
 Please note that the switching of the attenuators is relatively noisy and you can perceive it distinctly with a “click” for each switch operation.

11.16.2.3.2 Misc



Under the **Miscellanea** functions menu it is possible to activate or exclude the **Preselector** filters and also to enter in the **Tracking generator** menu pressing the **RF OUT** button.

The Preselector is composed by a group of filters automatically selected by the PMM 9030/9060/9180 while it is sweeping or anyway measuring. The aim of the preselector is to reduce the amount of out-of-band energy entering in the receiver, thus helping a lot in reducing intermodulation problems and similar undesired behaviors.
 It can be set either ON or OFF with the associated button, and normally it should be always enabled.
 On the top left corner of the screen the symbol “Off” or “On” will be displayed.
 Pressing the **RF OUT** button the receiver enters the Tracking generator menu.

11.16.2.3.3 Tracking generator



The **Tracking generator** is an internal, high stability and accuracy, 50 Ohm RF generator ranging from 10 Hz to 50 MHz.
 It is a CW signal source tuned at the frequency set under the **RF OUT** Freq window.
 As usual, to set a given frequency it is therefore enough to edit the value with the soft keys and the left and right arrows, confirming the selections entering the units value (kHz, MHz or GHz).
 Pressing 0 as the first figure the decimal dot appears automatically.

The output level can be set between 60,0 and 90,0 dBμV with 0,1dB steps using the **RF OUT** Level button.
 If a higher or lower level is needed, the User shall adopt either an external amplifier or an external attenuator.

With the PMM 9030/9060/9180 the **Tracking On** function is not available.

11.16.2.3.4 Detector



This menu allows the operator to select the most appropriate **detector** for the test.

In Sweep mode the Peak, Average, RMS (Root Mean Square) and Quasi-Peak detectors are available and can be selected via the appropriate button.

Hold time (ms)

The Hold Time (expressed in milliseconds) represents the time the receiver uses to “take a snapshot” of the incoming signal and to measure it with the chosen detector. When selecting a detector, the default hold time value is automatically loaded, but in some cases this time is not appropriate, e.g. when the interference signals have a low repetition rate. In this case the PMM 9010 sees a high input signal and therefore tries to set the proper attenuation automatically increasing the value or the input attenuators. However, when the input attenuation is set the signal is gone, so the receiver lowers the attenuation, but then a new peak arrives, and so on and so forth.

On the other hand, if the **Hold Time** is too high the PMM 9010 cannot properly follow the signals.

In this situation the Hold Time value should be manually set to find a correct compromise.

To set the **Hold Time** to the lowest possible value (this value dynamically depends from the measurement conditions), enter the figure 0; if a value lower than the allowed is entered, the lowest possible value is automatically selected.

The max. **Hold Time** that can be set is 30 sec (30.000 ms).

11.16.2.4 Conversion factor

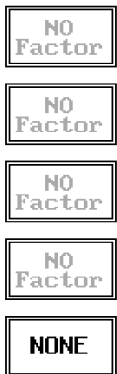

When using a transducer to make a measurement – a Voltage or Current Probe, an Antenna, etc. – there is always the need to add to the measured values the conversion factor of the transducer in use.

The Conversion factor may also take proper account of losses as cable loss, attenuators added externally to the receiver, etc.

The PMM 9030/9060/9180 can handle these factors in an automatic way and directly correct the readings.

The PMM 9030/9060/9180 can store in its internal non-volatile memory up to 4 different correction factors, and use them one at a time when recalled.

However, the **Conversion Factors** shall be created and loaded via the PMM 9010 Software Utility.

Load the conversion factor with the relevant button, and **NONE** to unload it.

11.16.3 Limit

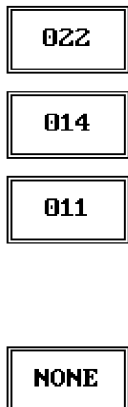

Each emission standard has one or more limits the User shall comply with. The PMM 9030/9060/9180 receiver has the possibility to load and activate one limit with a simple push of a button.

The preloaded standard limits refer to the most popular EMC emission standards: CISPR22, CISPR14 and CISPR11.

Other limits – or any custom designed limit – can be created, managed, selected and loaded through the PMM 9010 Software Utility running on a PC. These additional custom limits cannot be stored in the memory of the PMM 9030/9060/9180, but only in the one of the PC where the 9010SW Utility is running.

The limits are shown on the scan display and they appear like a thin black line .

By pressing the **NONE** button all limits are deactivated.



11.16.4 Display

Pressing the **Display** button it is possible to set two parameters: the visualized **Dynamic** range (chosen between 80, 100 and 120dB) and the **Reference Level**, that can be increased or reduced by steps of 5dB within the range +55 dB μ V to 90 dB μ V (-50 to - 15 dBm).

11.16.5 Marker

Marker
OFF

Peak

Highest
7

Analyzer

Tune

Selecting this function a **Marker** is immediately enabled, and it appears on the screen as a small black pointing down arrow corresponding to the highest reading; simultaneously a small window shows up in the bottom left corner of the screen, indicating the actual frequency and level read by the marker.

The Marker function is not a simple search for the highest readings on the screen – it would be a useless exercise that would display a number of points all grouped together – but it's a true peak search that measures the degree of variation of the signal: a peak is so classified only if it "pops-up" from the adjacent signals with a certain amount of dBs.

Following this criterion, if the measured signal is a flat line no peaks will be found.

Selecting **Highest X** – where X represents the maximum number of markers found by the receiver during its sweep – few more markers are added, each one diamond shaped, defined as per the previous explanation.

The maximum number of markers available is 10.

By using arrow keys it is possible to quickly move on markers from higher (left arrow) to lower (right arrow), i.e. if the highest is selected, pressing the right arrow key the 2nd highest is selected, then pressing again the same key the 3rd highest and so on and so forth.

It is also possible to use the rotary knob to move from a marker to the next one.

The marker under analysis (main marker) is a black arrow pointing down, the others are diamond shaped.

Pressing the **Peak** button the marker returns to the highest reading.

In order to make easier and faster the evaluation of the more noisy signals, the User can now select either the **Analyzer** or the **Tune** function, entering respectively into a spectrum analysis of main marker position or in the manual mode evaluation of it. To operate this two conditions please refer to the appropriate section of this Operating Manual.

In manual mode, i.e. having selected **Tune** on the main marker, it is possible to navigate from one peak to the other just pressing the arrow keys, without to come back to the Sweep display and remaining in manual mode.

This is another unique feature of PMM 9030/9060/9180 to improve the productivity of the test lab and make easier the work of the test engineer.

The **Marker Off** exits from the marker function.

11.16.6 Load Store



Pressing this key allows the User to have access to the memory of the receiver and enables the storing up to a number of different configurations/sweeps that depends on the parameters set on the receiver. For example, using standard CISPR parameters it is possible to store up to 5 sweeps on the C+D+E bands (RBW120 kHz and 1 MHz, respectively). Each new scan will be stored in the first available memory position thanks to the button **Store #x**, where x is the first available position. When all positions are occupied by a scan, this function is disabled until one of the previous scan is erased.

To load a stored trace, press the **Load #x** button until the proper scan is displayed; to unload a trace select the **Unload Trace** button. Please note that the Load function is scanning the memory in a circular way, therefore all the occupied memory positions are shown in sequence. When the key shows "Load #4", it means the trace #3 is displayed and that the #4 will be loaded after the key is pressed, and so on and so forth.

To erase a trace, press the **Erase#x** button. Due to the structure of the memory, it is possible to erase only the latest stored memory, with a sequence "LIFO" (Last In First Out), therefore after having erased the #x, the #(x-1) will be the trace to be erased. With reference to the example at the left, the last stored trace is the #4, and it is the first that will be erased. After that, the key will show "Erase #3", and so on and so forth.

A more advanced trace management could be done using the PMM 9010 Software Utility.



Turn Off the tracking generator, if it is not used, while you are in Scan Mode.
This prevents interferences and the measurements are more clean and accurate.

11.17 - Manual Mode Operating Instructions

11.17.1 Introduction



The **MANUAL mode** is a very useful feature to manually control the receiver and to deeply investigate electrical signals modifying the parameters of receiver exactly as per the needs of the Test Engineer.

It is possible, for example, to observe the signals exceeding the limits frequency by frequency; evaluating their levels measured simultaneously with 4 different detectors (Peak, QuasiPeak, Average and RMS); listening to them after a demodulation, etc.

To enter in **Manual Mode** press the key in the main menu, and immediately the first Manual window opens as follow.

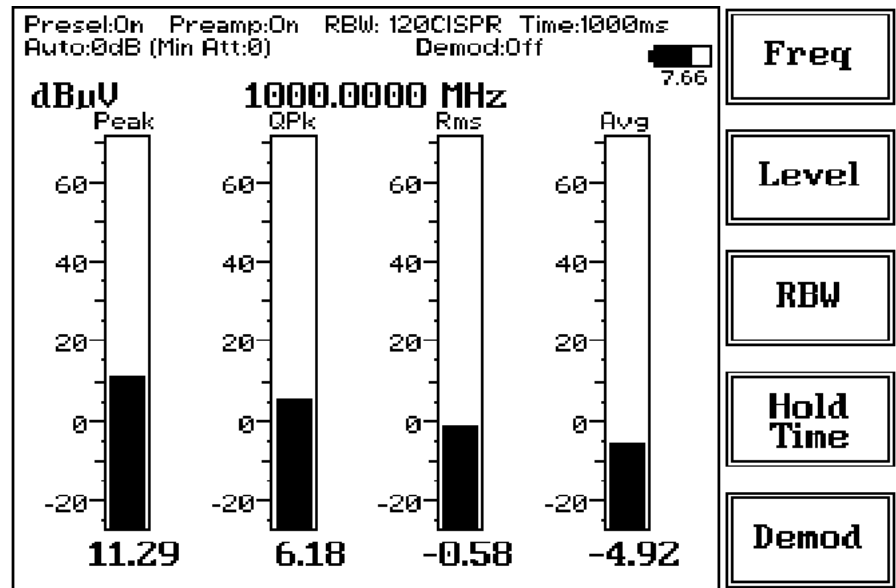

Fig. 11-10 Manual

In manual mode the levels corresponding to the detectors in use are displayed both in analogue and in digital format, and exactly as for the other operating modes, all the relevant information are reported on the screen.

From the upper left corner, the User can see if the Preselector is ON or OFF; if the Preamplifier is ON or OFF; the resolution bandwidth, the longest hold time associated to the detectors in use; if the input attenuation is Automatic or Manual and the set attenuation and if the Minimum attenuation is 10 dB or 0dB; if there a demodulation and the level of the volume, represented by a small black bar.

Then there are three or four vertical bars representing the detectors and indicating in analogue and digital (the figures below each bar) the level measured; on top of the bars the relevant detector, the unit in use and the tuned frequency. The analogue scale of the analogue bars is set automatically by the receiver.



The Manual mode function has five sub windows:

- Frequency
- Level
- Resolution Bandwidth
- Hold Time
- Demodulation

Always use Esc button to return to the previous view/condition.

11.17.2 Frequency

Under this menu it is possible to set the tuning frequency and also the knob and the arrow keys steps.



The center Frequency of the reading can be directly edited into the **Tune** window or set by the left and right arrow buttons or by rotating the knob. The figures entered appear in a small window just below the graph and the default unit is MHz.

Having selected **Tune**, the figures 0, 1, 2, 3, and 4 are selectable at first; with the right arrow key it is possible to select the figures from 5 to 9, and pressing again the right arrow key the units kHz, MHz and GHz becomes accessible, as well as the decimal dot and the Back Space. The left arrow key can be used as well to move back and forth from one screen to the other. Pressing 0 as the first figure the decimal dot appears automatically. To set a given frequency it is therefore enough to edit the value with the soft keys and the left and right arrows, confirming the selections entering the units value (kHz, MHz or GHz).

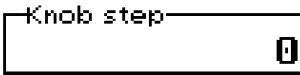

If **Knob** is selected, the small window below the bars indicate the step which is going to be selected. After having fixed the step size, rotate the knob and tune the desired frequency.

If **Arrow** is selected, the small window below the bars indicate the step which is going to be selected. After having fixed the step size, press the left and the right arrow keys to decrease or increase the frequency by the selected step.

11.17.3 Level

The Level function has 4 sub-menus.



Pressing the **Display** button it is possible to set two parameters: the visualized **Dynamic** range (chosen between 80, 100 and 120dB) and the **Reference Level**, that can be increased or reduced by steps of 5dB within the range +57 dB μ V to 92 dB μ V (-50 to -15 dBm).

The **Input** button opens a submenu which is dedicated to the setting of the input attenuator and to switch on-off the built-in preamplifier.

The PMM 9030/9060/9180 receiver takes automatically into account the settings of all the Input parameters and always displays the correct value of the level. The User is not required to make any correction to the readings.



11.17.3.1 Input:

Attenuator and preamplifier



Being entered in the Input submenu, to increase or decrease the attenuation at the input, press **Att +** or **Att -**, and for each touch the attenuation is increased or decreased of 5 dB (preset value) up to the max attenuation available of 55 dB.

Depressing either one of these keys force the receiver in manual attenuation.

The **Min Att** button acts as a toggle switch: it selects or deselects the minimum attenuation of 10 dB. When the minimum attenuation is selected, the attenuator – doesn't matter if in automatic or in manual condition - cannot be lowered under 10 dB.

Unless specifically required by the test conditions, do not remove the minimum attenuation of 10 dB.

With the **Preamp** key it is possible to insert or exclude the built-in low noise preamplification of 10 dB.

The internal 10 dB preamplifier can be used when very weak signals have to be investigated. As already mentioned, with the preamplifier ON the receiver takes automatically care of the 10 dB gain when measuring the signals.

The Preamplifier must be mandatory switched off (default) while carrying on CISPR measurements.

The **Att Auto** button is used to switch from the two conditions of manual or automatic attenuation setting.

Please note that the switching of the attenuators is relatively noisy and you can perceive it distinctly with a "click" for each switch operation.

Using 0 dB attenuation PMM 9030/9060/9180 has no input protection. This is a potentially dangerous condition for the input stage of the receiver.

Use 0 dB attenuation only if you are very sure that your input signal is less than 1 V (or 120 dBµV).

Before to apply an unknown signal to PMM 9030/9060/9180 receiver, use an oscilloscope or a wide band RF voltmeter to measure it. In any case set Min. ATT at 10 dB and select the maximum available attenuation with preamplifier OFF.

If needed, add an external coaxial attenuator on the input signal line.



In case an OVERLOAD indication occurs it is necessary to add an external attenuator to carry on the measurement without overpassing the declared limit for continuous power or spectral density.

11.17.3.2 Misc



Under the **Miscellaneous** functions menu it is possible to activate or exclude the **Preselector** filters and also to set the **Tracking generator**.

The **Preselector** is composed by a group of filters automatically selected by the PMM 9030/9060/9180 while it is sweeping or anyway measuring. The aim of the preselector is to reduce the amount of out-of-band energy entering in the receiver, thus helping a lot in reducing intermodulation problems and similar undesired behaviors. It can be set either ON or OFF with the associated button, and normally it should be always enabled.

On the top left corner of the screen the symbol "Off" or "On" will be displayed.

Pressing the **RF OUT** button the receiver enters the **Tracking generator** menu.

The **Tracking generator** is an internal, high stability and accuracy, 50 Ohm RF generator ranging from 10 Hz to 50 MHz.

It is a CW signal source tuned at the frequency set under the **RF OUT** Freq window.

As usual, to set a given frequency it is therefore enough to edit the value with the soft keys and the left and right arrows, confirming the selections entering the units value (kHz, MHz or GHz).

Pressing 0 as the first figure the decimal dot appears automatically.

The output level can be set between 60,0 and 90,0 dBµV with 0,1dB steps using the **RF OUT** Level button.

If a higher or lower level is needed, the User shall adopt either an external amplifier or an external attenuator.

With the PMM 9030/9060/9180 the **Tracking On** function is not available.

11.17.4 RBW

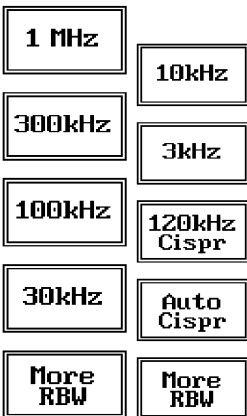

The **Resolution Bandwidth** command is used to select the bandwidth of the measuring filter. Seven bandwidth filters are available:

- 120 kHz CISPR 16
- 3 kHz
- 10 kHz
- 30 kHz
- 100 kHz
- 300 kHz
- 1 MHz (Bimp)

The four larger filters are selectable from the first RBW screen, and pressing the **More RBW** button it is possible to select all the other filters.

These filters are mathematically modeled using FIR (Finite Impulse Response) technique and they are exactly as required by the standards.

More filters will be available as an option for specific applications, e.g. to cover Military Standards requirements, etc.

With the **Auto Cispr** function, the filter will be automatically selected, according to CISPR standard, depending on the tuned frequency.

When a non-CISPR filter is selected, the Quasi Peak detector is disabled.



11.17.5 Hold Time

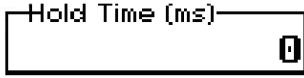

The Hold Time (expressed in milliseconds) represents the time the receiver uses to “take a snapshot” of the incoming signal and to measure it with the chosen detector. When selecting a detector, the default hold time value is automatically loaded, but in some cases this time is not appropriate, e.g. when the interference signals have a low repetition rate. In this case the PMM 9030/9060/9180 sees a high input signal and therefore tries to set the proper attenuation automatically increasing the value or the input attenuators. However, when the input attenuation is set the signal is gone, so the receiver lowers the attenuation, but then a new peak arrives, and so on and so forth.

On the other hand, if the Hold Time is too high the PMM 9030/9060/9180 cannot properly follow the signals.

In this situation the Hold Time value should be manually set to find a correct compromise.

To set the Hold Time to the lowest possible value (this value dynamically depends from the measurement conditions), enter the figure 0; if a value lower than the allowed is entered, the lowest possible value is automatically selected.

The max. Hold Time that can be set is 30 sec (30.000 ms).

11.17.6 Demodulator



Switching ON the built-in AM demodulator, the volume can be adjusted with the rotating knob, and the level is shown by the black bar on the screen.

The demodulated signals can be heard with headphones or earphones connected to the front panel of the PMM 9010, or amplified and/or recorded by any suitable device.

An FM demodulator – or other demodulators - is not available for the time being in the frequency band covered by the PMM 9030/9060/9180.

Demod:



Insert the headphones jack connector only before switching on the Demodulator or when the PMM 9010 power is off.

11.18 – Updating firmware

11.18.1 Introduction

The PMM 9030/9060/9180 features a simple and user-friendly method for updating its internal firmware through a Personal Computer (PC). This section provides all the information required for easy updating. This procedure concerns the firmware updating of RF modules 9030/9060/9180 only.

11.18.2 System Requirements

The minimum requirements to allow the software to operate properly are the following:

- 486 Processor or Pentium
- 16 Mb of RAM
- at least 10 Mb of free space on hard disk
- 1 free Serial Port (RS-232), or, alternatively, a USB/RS-232 Adapter with related driver
- Windows Operating System™ 95/98/2000/XP/Vista/Win7



The User must have administrator privileges to install the software in Windows 7; right click on the program .exe file and click on “Run as administrator” to temporarily run the program or application as an administrator until close it (Windows 7 also allows to mark an application so that it always runs with administrator rights).

11.18.3 Preparing the Hardware

Turn off the PMM 9030/9060/9180 and connect the RS-232 cable directly or through a USB/RS-232 Adapter separately purchased (once related driver has been properly installed), to the 9 pin socket situated on the back panel of PMM 9030/9060/9180 on one side and to a free RS232 port (or USB in case of Adapter’s use) on the PC side.

The first free RS-232 port will be automatically detected by the Firmware Update Program during installation. In case of troubles please check port assignments on the PC through the Control Panel utility.



The firmware storing procedure does not require the optical link between 9010 series and 9030/9060/9180.

11.18.4 Software Installation

The **9030SeriesUp** executable program is provided together with the PMM 9010 Receiver package, burned on a CD-ROM; anyway it’s always possible to check for newer releases and download them from official NARDA Italy Web Site Support page.

Once the **9030SeriesUp Setup** has been installed in the PC, another item is created in the Programs list at Start Menu, which is **“PMM Emission Suite”**, from where the **“9030-9060-9180 SeriesUp”** program can be easily run.



Click on “9030-9060-9180 SeriesUp” (9030SeriesUp.exe) once for running the update program, so getting the following window:



Two firmware components can be updated by this application: Firmware, which is the receiver internal program, and FPGA, to update the internal programmable logic.

The .ldr file required for Firmware updating and the .bin file for FPGA are automatically stored in the same directory of the 9030SeriesUp.exe, otherwise just copy them there before performing the upgrade:

- **PMM 9030**: “9030FW.ldr” for FW; “run9030.bin” for the FPGA.
- **PMM 9060**: “9060FW.ldr” for FW; “run9060.bin” for the FPGA.
- **PMM 9180**: “9180FW.ldr” for FW; “run9180.bin” for the FPGA.



To obtain up-to-date Firmware for PMM 9030/9060/9180, the user can contact his NARDA distributor or download it directly from Support area of EMC Product Range on the following Web Site: www.narda-sts.it.



Be sure batteries of PMM 9030/9060/9180 and connected Laptop (PC) are fully charged before performing the FW Upgrade, otherwise the upgrade progress could not terminate properly.

Alternatively, be sure to have both PMM 9030/9060/9180 and Laptop (PC) powered through their respective AC/DC power adapters.

Anyway, even in case of failure, the internal BIOS will never be corrupted and you’ll just need to repeat the procedure once more (this is a unique feature!).

Should FW Upgrade procedure stop before reaching the 100% completion that will have not to be considered a trouble but simply an intermediate step: in this case please switch OFF and ON the receiver and repeat the FW Upgrade procedure once more until the end.

Always cycle power OFF and ON again after every FW Upgrade.

11.18.5 To transfer data Choose the serial port used for the communication with the RF module and click on “RS232”.

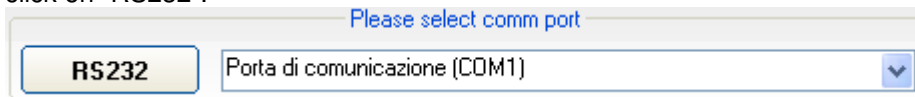

The message “Please turn on the unit, then click OK” is displayed:

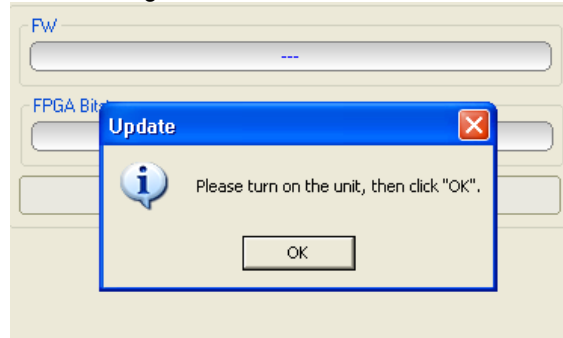

The RF module turned on automatically, otherwise do it manually. Click on “OK”.

The SW identifies the RF module model, displays FW release and installed FPGA, switch off the RF module and displays the message “Please turn on 9030/9060/9180 again, then click OK”.

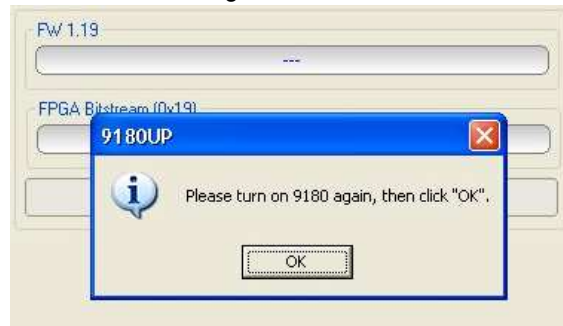

Turn the RF model on manually and click on “OK”.

The key “Update Firmware & FPGA” is now enabled; click on it to start the firmware updating.



FW and FPGA are both always updated: FW first, then the FPGA; updating FW or FPGA separately, or other procedures are not allowed.

During the firmware storing procedure the operation, the SW shows the file in progress of uploading (below it is shown the PMM 9180 Firmware updating process as example):



The message “N° Bytes have been stored” appears at the process end, showing the number of Bytes written into the instrument.



WARNING

To use the PMM 9030/9060/9180 with the PMM 9010F, the following Firmware and FPGA release are needed:

- PMM 9010F: 9010F_FW.ldr rel. 1.17 or higher
Check.bin file (No Release)
Radiated.bin file (No Release)
- PMM 9030: 9030FW.ldr rel. 1.19 or higher.
run9030.bin rel. 0x19 or higher.
- PMM 9060: 9060FW.ldr rel. 1.20 or higher.
run9060.bin rel. 0x16 or higher
- PMM 9180: 9180FW.ldr rel. 1.19 or higher.
run9180.bin rel. 0x13 or higher

NOTE

For updating the firmware of the 9010F, please refer to the Chapter 8 and in addition pay attention to update the FPGA for radiated too.

NOTE

In case the release should not comply with what expected, just check about the FW file used during installation or get in contact with the nearest NARDA Local Distributor.

This page has been left blank intentionally

12 – PMM 9010-RMA Rack Mount Adapter for Rack 19” (Option)



12.1 Introduction

A **19-inch rack** is a standardized frame or enclosure for mounting multiple equipment modules. Equipment designed to be placed in a rack is typically described as **rack-mount** or simply **chassis**; the height of the electronic modules is standardized as multiples of 1.75 inches (44.5 mm) or one rack unit or "U". Each module has a front panel that is 19 inches (482.6 mm) wide, including edges that protrude on each side which allow the module to be fastened to the rack frame with screws.

12.2 Instrument Items

PMM 9010-RMA Rack Mount Adapter includes the following items:

- Rack Mount kit (screws, plastic round washers and cage nuts).
- Return for Repair Form.

12.3 Optional accessories

PMM 9010-RMA Rack Mount Adapter can be used with several optional accessories, the most common being the following:

- PMM 9010 EMI Receiver 10 Hz ÷ 30 MHz;
- PMM 9010/03P EMI Receiver 30 MHz ÷ 300 MHz
- PMM 9010/30P EMI Receiver 30 MHz ÷ 3 GHz;
- PMM 9010/60P EMI Receiver 30 MHz ÷ 6 GHz

12.4 PMM 9010-RMA Main Specifications

Table 12-1 lists the PMM 9010-RMA specifications.

TABLE 12-1 Technical Specifications	
Environment temperature	0° to 40°C
Rack unit	3U
Dimensions	483 x 410 x 132.5 mm (WxDxH)
Weight	5,5 Kg (without instruments)

12.5 PMM 9010-RMA Front view

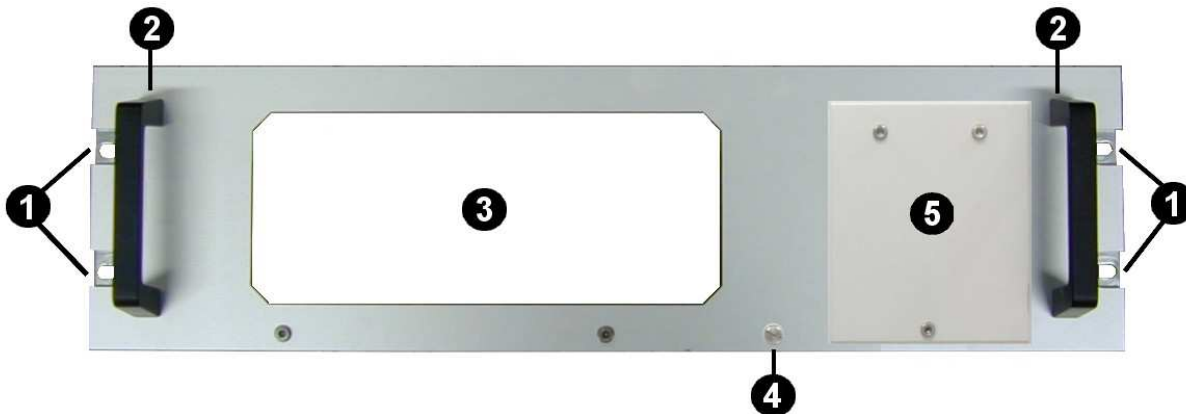

Fig. 12-1 Front view

Legend::

- 1 – Holes Flanges used to fix the Rack Mount to the Rack
- 2 – Handles used to carry the Rack Mount
- 3 – PMM 9010 or 9010/03P/30P/60P window
- 4 – Milled knob used to fix the frontal panel to the Rack
- 5 – Cover for future implementation

12.6 PMM 9010-RMA Inside view



Fig. 12-2 Inside view

Legend::

- 1 – Round holes of service
- 2 – Rectangular holes used to put 9010 or 9010/03P/30P/60P Instrument;
- 3 - 9010 or 9010/03P/30P/60P straps;
- 4 – Rectangular holes for future implementation;
- 5 – Straps for future implementation.

12.7 Rack Requirements The rack must be of the following type:

- Standard 19 inch (483 mm) with mounting rails that conform to English universal hole spacing per section 1 of ANSI/EIA-310-D-1992.
- The minimum vertical rack space per chassis must be 3U (rack units), equal to 3 inches (132.5 cm).

12.8 Required Equipment Before you begin the installation, ensure that you have the following items:

- Crosshead screwdriver (not provided)
- Flat-blade screwdriver or rack-insertion tool (not provided)
- Tape measure and level (not provided)
- Rack Mount kit (provided)

12.9 Moving chassis When lifting the chassis, be aware of its weight, and follow these guidelines:

- Disconnect all power and external cables before lifting the chassis.
- Remove all instruments from the chassis before lifting.



- **Make sure that the milled knob well locking.**
- Using the two handles, lift the PMM 9010-RMA slowly keeping your back straight. Lift with your legs, not with your back. Bend at the knees, not at the waist.

12.10 Installation guidelines

When installing the chassis, follow these guidelines:

- Plan your site configuration and prepare the site before installing the chassis.
- Ensure that there is adequate space around the rack to allow for servicing the chassis and for airflow.
- If the rack has wheels, ensure that the brakes are engaged or that the rack is otherwise stabilized



- For a round hole (tapped) rack, use clip nuts with M6 x 16 screw (not provided).

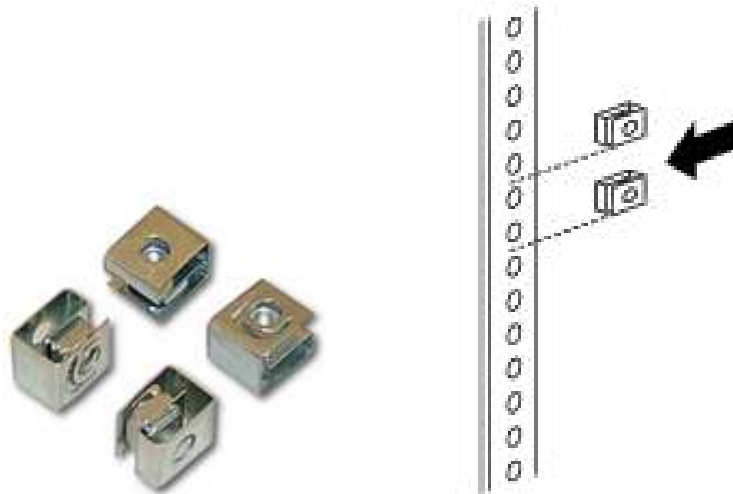

- For a square hole (untapped) rack (shown below), use M6 x 16 screws, plastic round washers head screws and M6 cage nut (provided).



12.11 Installing the PMM 9010-RMA

This section describes how to install the PMM 9010-RMA Rack Mount Adapter:

- Insert the cage nuts behind the vertical rails with respect to the Rack Unit Boundary and the distance show below:

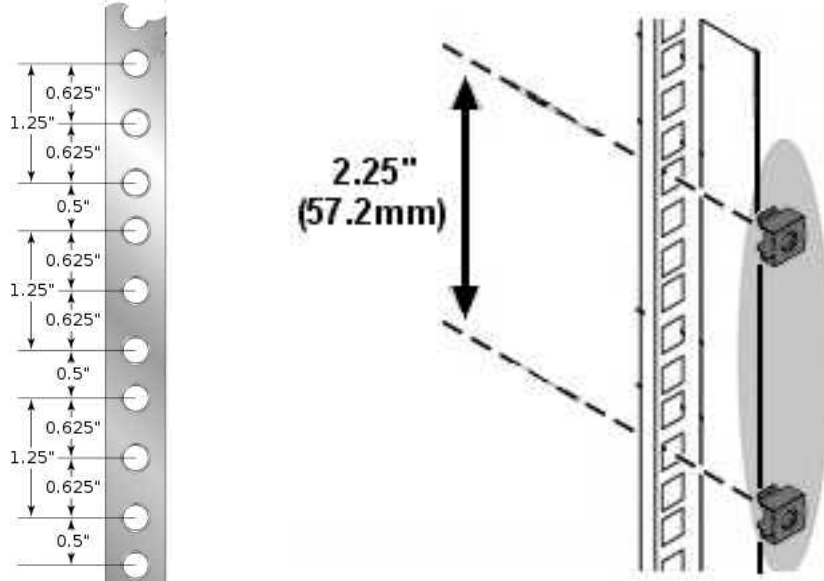

- You can use a rack-insertion tool or a flat-blade screwdriver to install the cage nuts.

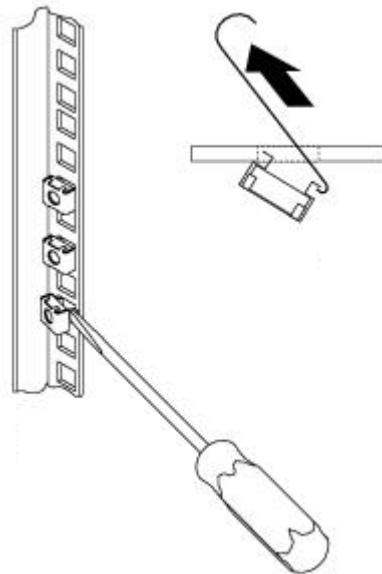

- Insert the chassis into the rack.
- Slide the chassis into the rack until the front flange is flat against the cage nuts.
- Using the four screws and black plastic washers, fix the chassis by its flanges to the rack.

12.12 Use of the PMM 9010-RMA with PMM 9010

The following procedure is indifferently referred to the 9010 or 9010/03P/30P/60P.

This section provides the information needed to install your 9010 Instrument on the PMM 9010-RMA Rack Mount Adapter.

- Remove the frontal panel from the Rack unscrewing the milled knob without loosing it completely.
- Using the handles, open the PMM 9010-RMA slowly.
- Place the instrument by the rectangular holes and drag the instrument in contact with the frontal panel.
- To ensure the necessary stability, the instrument must be fastened to the unit using the straps.
- Connect the cables on the rear panel (see “Installation” chapter for further information)
- To fix the rear cables to the Rack Mount insert plastic straps by of the round holes.
- Using the handles, close the PMM 9010-RMA slowly.

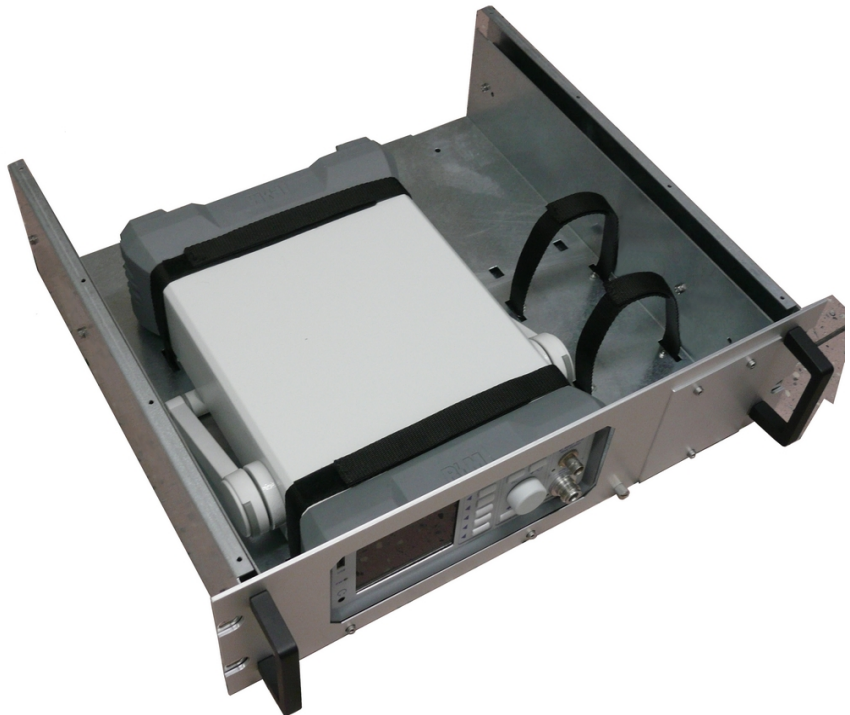

Fig. 12-3 PMM 9010-RMA with 9010 Instrument

This page has been left blank intentionally

13 – APD Mode Operating Instructions (Amplitude Probability Distribution)

13.1 Introduction

EM disturbances have become much more complicated since introduction of digital radio communication system over 1 GHz, in a way that radiated emission noise from EUTs has become broadband.

An APD-measuring function has been introduced in the CISPR 16-1-1 Standard requirements for EMC Measuring Equipments, in order to detect both “broadband emissions” generated by repetitive pulses and “pulse-modulated narrowband emissions” at frequencies over 1 GHz.

The signal amplitude statistics are described in radio engineering as follows:

Amplitude Probability Distribution definition: $APD(E_k) = [\sum D_i(E_k)] / T_t$

Where E_k is the envelope of the noise, D_i is the duration of each relevant peak and T_t is the total measurement time.

APD statistics are needed to accurately predict non-gaussian noise effects coming from sources like lightning systems, electrical or electronic devices where average noise power detection cannot predict the performance of the EUT.

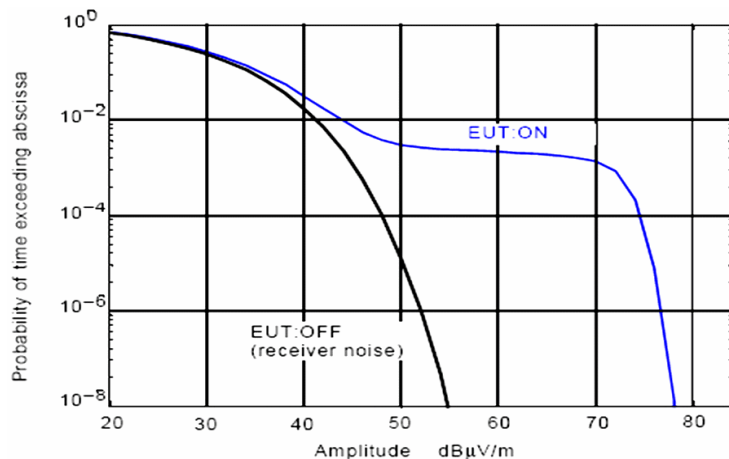

In the example above, taken from CISPR 16-1-1 Amend. 1, a typical APD representation is provided.

In such example, in particular, two different measurements conditions are shown, with and without an EUT operating at a specific distance from the measuring antenna, where the probability of the signal amplitude to be in the noise level of 20 dBµv/m is almost equal to “1” (i.e. always true) and is identical with or without contribution from EUT; such amplitude appears never exceeding the max value of 80 dBµv/m instead (probability < 10⁻⁸) when the EUT is ON, while there is almost the same, even if low, probability (10⁻³) that such a value remains between 50 and 70 dBµv/m.



All the following is indifferently referred to the PMM 9010 or the PMM 9010/03P/30P/60P.

Typical APD Noise Curve with PMM receiver



NOTE

Due to the good performances of PMM receiver the noise curve is very steep

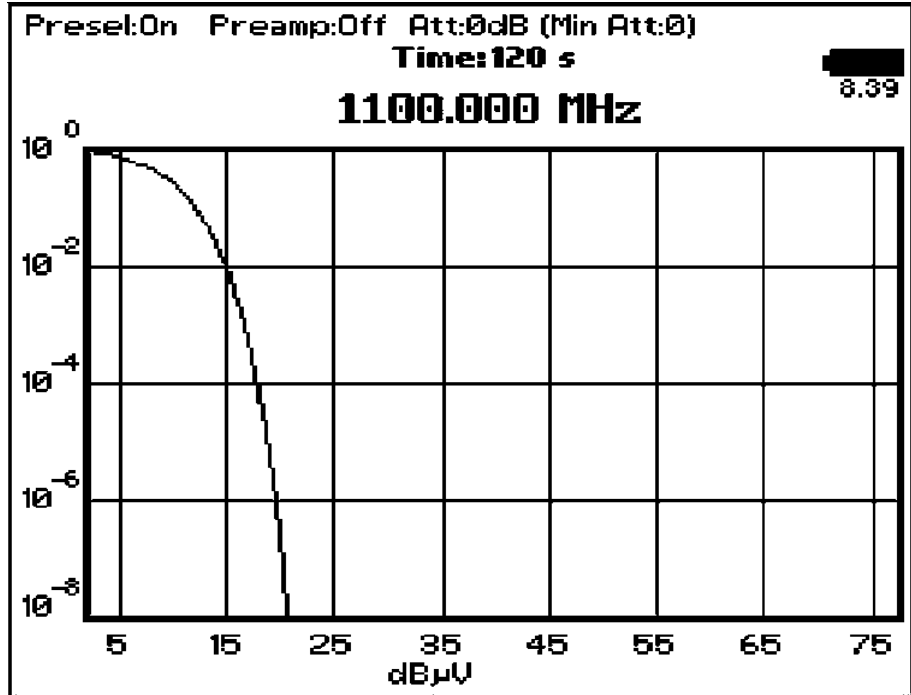

13.2 Pre-conditions and Settings

The APD function has been added to previous 9010 detection functions starting from 9010 FW Rel. 1.70 and 9030 FW Rel. 1.14, so please check about having these or newer FW releases on your equipments from Start-Up Screen at power-on, as shown in following picture.

```

9010-FW - 1.70 29/04/08 8.24
SDRAM 16 MB -> OK
Found CPLD --->(ID=0x1b)
FPGA Loaded --->(ID=0x20)
RSP OK
Serial Flash Ok ( 20 Mb found)
Parallel Flash Ok (8Mb)
Main Board ID=153WJ80204
KeyPad OK
SerDes Code=0xa

9030-FW - 1.14 14/06/07
SDRAM 16 MB -> OK
FPGA Loaded --->(ID=0x19)
Serial flash 20 Mb found
RF module Ok
7.71
    
```

Analyzer
Sweep
Manual
APD
Setup

On the contrary please access NARDA web site to download latest available FW release and update your unit.

13.2.1 Entering the function



The **Amplitude Probability Distribution** mode can be used when measuring signals in the frequency range from 30 MHz on with 9030/9060/9180.

As soon as 9030/9060/9180 is connected and switched on, turning on the 9010 provides the APD button appearing at the function keys 4th position from the top (see picture).

Obviously the PMM 9030/9060/9180 unit must be connected to the 9010 to allow operating in the higher frequency bands.

This is a very powerful and innovative function for an EMI receiver. To enter this mode simply depress the APD soft key on the main screen and the APD setup window will pop up immediately, allowing operator to set parameters for the measure. All these settings (Limits, Frequencies, Hold Time etc.) refer to the each specific product standard and can be preset by pressing the Default key.

13.2.2 Methods

The Amplitude Probability Distribution is a statistical characterization of signals. Measurements are based on 1 MHz RBW and have to be performed over a number of frequencies typically above 1 GHz, but can also be carried out below.

Two methods are defined: the first "E based" and the second "P based".

For Method 1 (E) it is necessary to measure disturbance level E_{meas} related to specified P_{limit}

In this case EUT complies with the standard if E_{meas} is less or equal to E_{lim}

For Method 2 (P) it is necessary to measure the probability of time P_{meas} during which the disturbance envelope exceeds the limit E_{lim}

In this case EUT complies with the standard if P_{meas} is less or equal to P_{lim}

13.3 Setup

As for the Sweep and Click operating modes, all the relevant information are reported on the screen.

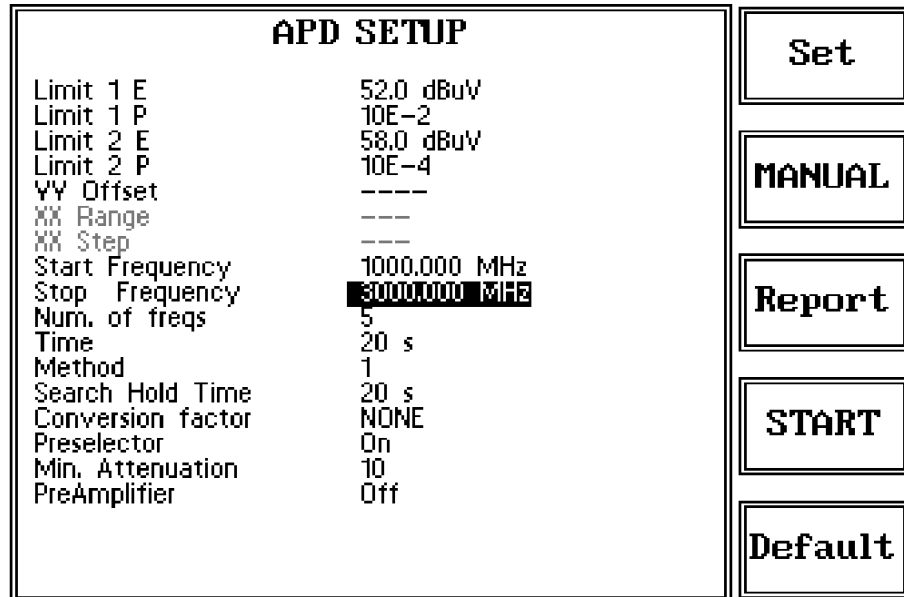

Fig. 4-1 APD Setup



Thanks to its digital architecture and to the clever design, the PMM 9010/9030/9060/9180 receiver can make very fast and precise measurements in compliance to both methods (E & P) of the CISPR 16-1-1 standard.

13.3.1 Limit 1 E

Moving the highlighter cursor on the first line of the Setup page the threshold level for the first limit can be entered using the function keys on the right.

The range for this limit is between 10 and 120 dB μ V (default: 52dB μ V).

Enter a 0 (zero) to disable the limit.
If the limit is disabled a series of dashes (----) is displayed.

13.3.2 Limit 1 P

Moving the highlighter cursor on the second line of the Setup page the threshold percentage of probability, expressed in power of ten, for the first limit can be entered using the function keys on the right.

The range for this limit is between 10⁰ and 10⁻⁸ dB μ V (default: 10E-2).
Only the positive number of the exponent needs to be entered.
To set 10⁰ a value of 0.1 must be input.

Enter a 0 (zero) to disable the limit.
If the limit is disabled a series of dashes (----) is displayed.

13.3.3 Limit 2 E

Moving the highlighter cursor on the third line of the Setup page the threshold level for the second limit can be entered using the function keys on the right.

The range for this limit is between 10 and 120 dB μ V (default: 58dB μ V).

Enter a 0 (zero) to disable the limit.
If the limit is disabled a series of dashes (----) is displayed.

**13.3.4 Limit 2 P**

Moving the highlighter cursor on the fourth line of the Setup page the threshold percentage of probability, expressed in power of ten, for the second limit can be entered using the function keys on the right.

The range for this limit is between 10^0 and 10^{-8} dB μ V (default: 10E-4). Only the positive number of the exponent needs to be entered. To set 10^0 a value of 0.1 must be digitized.

Enter a 0 (zero) to disable the limit.
If the limit is disabled a series of dashes (----) is displayed.

13.3.5 YY Offset

When the YY Offset function is activated, only the frequencies with a level over the higher between the two limits (+ offset) will be investigated during the test.

Moving the highlighter cursor on the fifth line of the Setup page the offset, expressed in dB, related to the first Limit 1 E can be entered using the function keys on the right.

The range for this value is between 0 dB and 150 dB.
To set 0 dB a value of 0.01 must be digitized.

Enter a 0 (zero) to disable this function.
If the limit is disabled a series of dashes (----) is displayed (default).

13.3.6 Start Frequency

Moving the highlighter cursor on the eighth line of the Setup page the starting frequency for the searching sweep, expressed in MHz, can be entered using the function keys on the right.

The range for this value is between 30 and 3000 MHz.
When a value outside the range is entered the default 1000 MHz is automatically set.

13.3.7 Stop Frequency

Moving the highlighter cursor on the ninth line of the Setup page the end frequency for the searching sweep, expressed in MHz, can be entered using the function keys on the right.

The range for this value is between 30 and 3000 MHz.
When a value outside the range is entered the default 3000 MHz is automatically set.

13.3.8 Num. of freqs

Moving the highlighter cursor on the tenth line of the Setup page the number of frequencies for the searching sweep, the ones that will be further investigated, can be entered using the function keys on the right.

The range for this value is between 2 and 50.
When a value outside the range is entered the default number of 5 is automatically set.

13.3.9 Time

Moving the highlighter cursor on the eleventh line of the Setup page the time period for each frequency measurement after the sweep can be entered using the function keys on the right.

The range for this value is between 2 and 120s.
 When a value outside the range is entered the default 20s is automatically set.
 If a value higher of the one set for the Search Hold Time is entered, the Search Hold Time is automatically adapted to the same duration.

13.3.10 Method

Moving the highlighter cursor on the twelfth line of the Setup page the method for the measurement can be entered between Method 1 (E based - default) and Method 2 (P based).

The choice is possible by pressing the Change Key.

13.3.11 Search Hold Time

Moving the highlighter cursor on the thirteenth line of the Setup page the time duration for the sweep search can be entered using the function keys on the right.

The range for this value is between 2 and 1000s.
 When a value outside the range, or lower then the Time parameter, is entered the default 20s is automatically set or it is adapted to the Time duration.

13.3.12 Conversion Factor



Moving the highlighter cursor on the fourteenth line of the Setup page one of the stored Conversion Factors can be chosen from the list on the right.

This functionality is useful when using a transducer to make a measurement – a Voltage or Current Probe, an Antenna, etc. – as there is always the need to add to the measured values the conversion factor of the transducer in use. The Conversion factor may also take proper account of losses as cable loss, attenuators added externally to the receiver, etc.
 The PMM 9010 can handle these factors in an automatic way and directly correct the readings.

The PMM 9010 can store in its internal non-volatile memory up to 4 different correction factors, and use them one at a time when recalled.
 However, the **Conversion Factors** shall be created and loaded via the PMM 9010 Software Utility.

Press the relevant button to load the conversion factor, and **NONE** to unload it (default).

13.3.13 Preselector

Moving the highlighter cursor on the fifteenth line of the Setup page the internal Preselector filter can be activated (On, default) or deactivated (Off).

The choice is possible by pressing the Change Key.



13.3.14 Min. Attenuation

Moving the highlighter cursor on the sixteenth line of the Setup page the Minimum Attenuation can be entered using the function keys on the right.

The range for this value is between 0 and 50dB in 10dB steps (default: 10dB).



It is recommended to set the highest Min. Attenuation when the input signal level is not predictable, to prevent damages to the input stage.

13.3.15 PreAmplifier

Moving the highlighter cursor on the seventeenth line of the Setup page the internal Preamplicifier can be activated (On) or deactivated (Off, default).

The choice is possible by pressing the Change Key.



It is recommended to switch the Preamplicifier off when the input signal level is not predictable to prevent damages to the input stage.

13.4 Operation

The APD mode function is divided into five sub windows:



- Set
- Manual
- Report
- Start
- Default

The purpose of the Set key has been already described.

Always use Esc button to return to the previous view/condition.

13.4.1 MANUAL (APD)

Pressing **MANUAL** key the following screen appears:

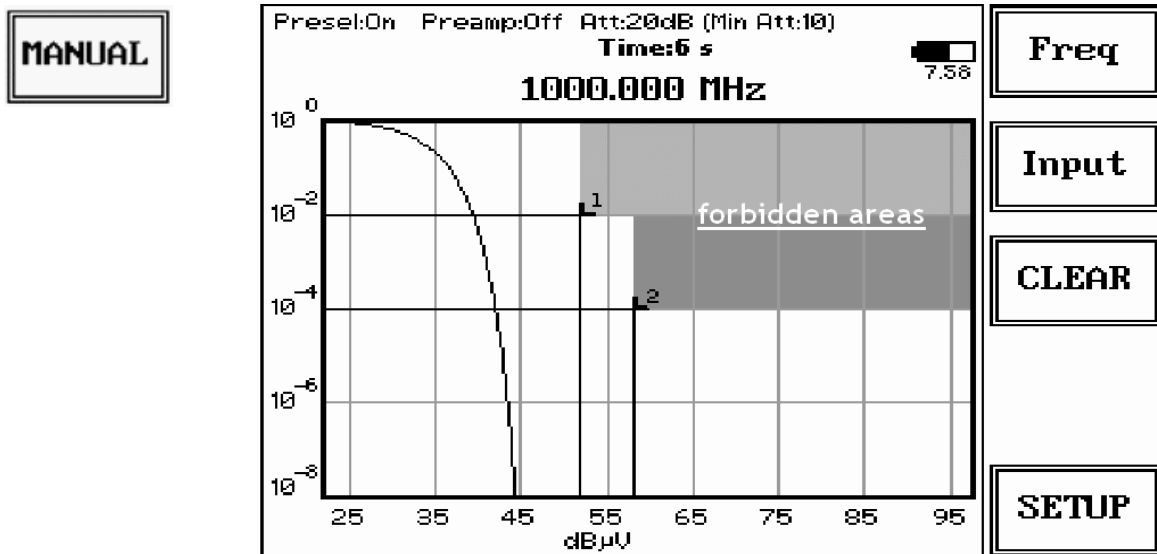

Please consider the two gray colored areas (forbidden areas) are not represented with shadows, like in the picture above, on the equipment.

This mode of operation is useful to check the DUT and try a debugging in real-time when needed.

From the upper left corner, the User can see if the Preselector is ON or OFF; if the Preamplifier is ON or OFF; which attenuation is in use and the minimum attenuation set (0 dB or 10dB or 20dB).

On the vertical axis of the graph Probability values are represented, expressed in power of ten. The maximum value is mandatory to be 100% of probability (10^0).

The horizontal axis indicates Level of the signal amplitude. CISPR standard recommends a Ref. Level (max value of the scale) equal to "Max Peak Value + 5dB".



During the test a counter is displayed in bold showing the time going on. The measurement ends when the period set in the Time field of the Setup page is elapsed.

The Limit is considered as Level & Probability, related to each other.

When set time is elapsed, the indication "PASS" or "FAIL" appears, depending on test result.

13.4.1.1 Frequency

Under this menu it is possible to set the tuning frequency and also the knob and the arrow keys' step.



The center Frequency of the reading can be directly edited into the **Tune** window or set by the left and right arrow buttons or by rotating the knob.



The figures entered appear in a small window just below the graph and the default unit is MHz.



Having selected **Tune**, the figures 0, 1, 2, 3, and 4 are selectable at first; with the right arrow key it is possible to select the figures from 5 to 9, and pressing again the right arrow key the units kHz, MHz and GHz becomes accessible, as well as the decimal dot and the Back Space. The left arrow key can be used as well to move back and forth from one screen to the other. Pressing 0 as the first figure the decimal dot appears automatically.

To set a given frequency it is therefore enough to edit the value with the soft keys and the left and right arrows, confirming the selections entering the units value (kHz, MHz or GHz).

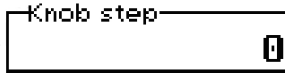

If **Knob** is selected, the small window below the bars indicates the step which is going to be selected. After having fixed the step size, rotate the knob and tune the desired frequency.

If **Arrow** is selected, the small window below the bars indicates the step which is going to be selected. After having fixed the step size, press the left and the right arrow keys to decrease or increase the frequency by the selected step.

13.4.1.2 Input



Being entered in the Input submenu, to increase or decrease the attenuation at the input, press **Att +** or **Att -**, and for each touch the attenuation is increased or decreased by 5 dB (preset value). Depressing one of these keys force the receiver in manual attenuation selection.

When the input attenuation is 0 dB (condition that can be achieved only if the Minimum Attenuation is set to 0 dB as well), the yellow led to the left of the input BNC connector is ON and indicates a warning status, just to advice the operator about no attenuation at all at RF input.

The **Min Att** button acts as a toggle switch: it selects the minimum attenuation between 0, 10 or 20 dB. When the minimum attenuation is selected, the attenuator – doesn't matter if in automatic or in manual condition - cannot be lowered under its value.

Unless specifically required by the test conditions, do not remove the minimum attenuation of 10 dB.

With the **Preamp** key it is possible to insert or exclude the built-in low noise pre-amplification of 10 dB (in the range 30 - 3000 MHz).

The internal 10 dB preamplifier can be used when very weak signals have to be investigated. As already mentioned in the general features description, with the preamplifier ON the receiver takes automatically into account the 10 dB compensation in the shown result.

Please note that switching of attenuators provides a low audible noise and it's absolutely normal to perceive it distinctly as a "click" at each switch operation.

The PMM 9010 receiver takes automatically into account the settings of all the **Input** parameters and always displays the correct value of the level. The User is not required to make any correction to the readings.



The **Preselector** is composed by a group of filters automatically selected by the PMM 9010/9030/9060/9180 while it is sweeping or anyway measuring. The aim of the preselector is to reduce the amount of out-of-band energy entering in the receiver, thus helping a lot in reducing intermodulation problems and similar undesired behaviors.

It can be set either ON or OFF with the associated button, and normally it should be always enabled.

On the top left corner of the screen the symbol "Off" or "On" will be displayed.



In case an OVERLOAD indication occurs it is necessary to add an external attenuator to carry on the measurement without overpassing the declared limit for continuous power or spectral density.

Using 0 dB attenuation PMM 9030/9060/9180 has no input protection. This is a potentially dangerous condition for the input stage of the receiver.

Use 0 dB attenuation only if you are very sure that your input signal is less than 1 V (or 120 dB μ V).



Before to apply an unknown signal to PMM 9030/9060/9180 receiver, use an oscilloscope or a wide band RF voltmeter to measure it. In any case set Min. ATT at 10 dB and select the maximum available attenuation with preamplifier OFF.

If needed, add an external coaxial attenuator on the input signal line.

13.4.1.3 CLEAR

Press this button to begin a new measurement.
The time counter restarts from 0 s.

13.4.1.4 SETUP

Press this button to go back to the Setup menu.

13.4.2 Report (APD)

Press this button to show the last generated Report of measurements.



APD Report								
MHz	Pk dBuV	ΔL Peak	$\Delta L1$	E	$\Delta L2$		Time	P/F
2399.750	74.4	11.4	19.6	*	13.8	*	20	FAIL
2804.000	33.5	-29.5	-23.2		-26.5		20	PASS
2793.500	33.3	-29.7	-23.6		-26.8		20	PASS
2832.500	33.3	-29.7	-23.0		-26.3		20	PASS
2881.000	33.3	-29.7	-22.7		-26.1		20	PASS

Press ESC button to go back to the Setup menu.

The report is represented as a table where the number of rows corresponds to the number of frequencies entered in the Setup and nine columns detailed below.

13.4.2.1 MHz

In the first column the frequencies (in MHz) are listed in order of level strength from the highest to the lowest.

13.4.2.2 Pk dB μ V

In the second column the measured Peak level for each frequency is shown. This is the result of the Peak detector with the Max Hold time set in the Time field of the Setup.

13.4.2.3 ΔL Peak

The third column shows the difference (in dB) between the level measured during the search and the limit for the level plus YY Offset entered in the Setup, for each frequency.

13.4.2.4 $\Delta L1$

The fourth column shows the difference (in dB) between the level measured during the search and the APD limit L1 entered in the Setup, for each frequency.

13.4.2.5 E

The fifth column shows a * if the limit L1 has been exceeded.

13.4.2.6 $\Delta L2$

The sixth column shows the difference (in dB) between the level measured during the search and the APD limit L2 entered in the Setup, for each frequency.

13.4.2.7

The seventh column shows a * if the limit L2 has been exceeded as for the fifth column.

13.4.2.8 Time

In the eighth column the time duration of the measurement is indicated for each frequency. Normally it is the duration set for the Time parameter of the Setup page, unless the test is manually interrupted before its programmed end.

13.4.2.9 P/F

The ninth column shows the test result (PASS/FAIL) for each frequency.



13.4.3 START (APD)

When the Start button is pressed the sweep between initial and stop frequency is performed for the period of time related to the value set in the Search Hold Time field.



PreSel:On Preamp:Off Det:Peak (0.1ms)
Auto:10dB (Min Att:10) (Rbw:1 M)
Ref:+115 dBuV 1204.500000 MHz

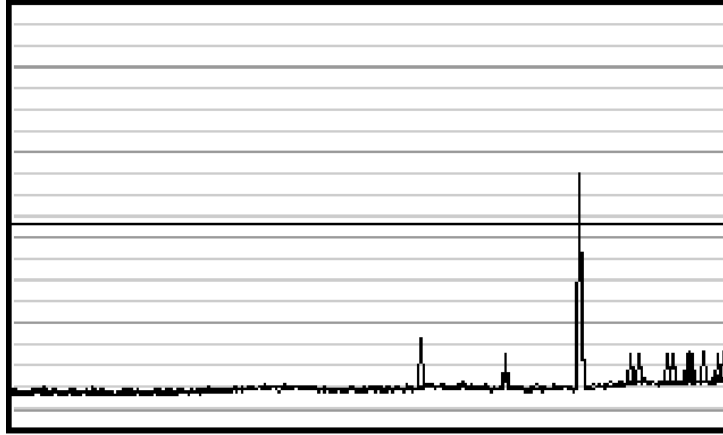

1000.00 MHz 3000.00 MHz
Limit:APD Peak



When a limit, and the YY Offset are activated, the highest of them, plus offset, is shown on the graph.

The frequencies overcoming the limit will be investigated in the next steps.

If the YY Offset is set to 0 (disabled) the highest signals will be further investigated even if they are under the limits.

13.4.3.1 Sweep running

From the upper left corner, the User can see if the Preselector is ON or OFF; if the Preamplifier is ON or OFF; which attenuation is in use and the minimum attenuation set (from 0 up to 50 dB).

The RBW for APD measurements must be mandatory set at 1 MHz and the detector is Peak.

The third line shows the Ref level and the sweeping frequency.

13.4.3.2 Signal by signal measurements

When the time for sweeping is elapsed the instrument automatically goes on to the steps in which each of the n frequencies (n is set in the Num. of freqs parameter) is measured for the period indicated in the Time field of the Setup page.

For each frequency the display shows a screen similar to the one in the following picture.

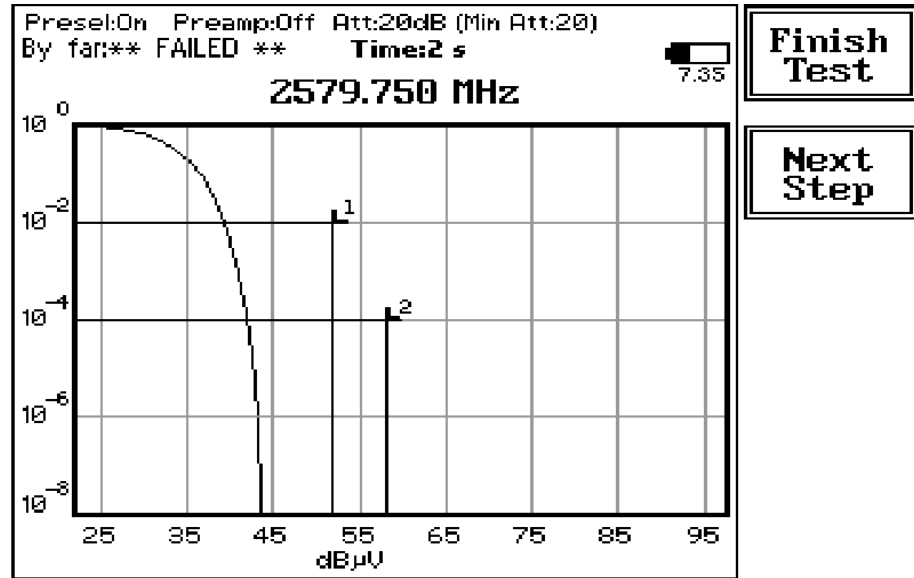

From the upper left corner, the User can see if the Preselector is ON or OFF, if the Preamplifier is ON or OFF, which attenuation is in use and the minimum attenuation set (from 0 up to 50 dB).

The RBW for APD measurements must be mandatory set at 1 MHz and the detector is Peak.

The second line shows whether the preceding step was Failed or Passed, and in bold the time counter. Each step ends automatically when a period equal to the value set in the Time field of the setup page is elapsed.

The third line shows in bold the tuned frequency, expressed in MHz.

On the right the battery icon indicates the charge status of the internal battery of the PMM 9010.

On the ordinate of the graph there is the scale of probability values, expressed in power of ten. The maximum value is mandatory to be 100% of probability (10⁰).

Below the graph the scale of the signal level is reported on the abscissa. Also the limits are indicated on the grid with related labels.

13.4.3.3 Finish and Next Step During the test it is possible to partially or totally skip each one of the n steps, using the Next Step key. There is also the possibility to finish the test at any time by pressing the Finish Test key. At the end of each step an indication "PASS" or "FAIL" appears for a while, depending on the test result.

13.4.3.4 Report When all the n steps are completed the final APD report appears on the screen. Refer to paragraph 13.4.2 of this manual for more information about APD Report table.

13.4.4 Default Press this button to restore the common (default) values for the whole Setup page. The values are indicated in the explanations of each parameter in chapter 13.3 of the present manual.



13.5 Internal generator



Also in APD mode the PMM 9010 internal RF signal generator is available. To activate the generator it is necessary to go back to the initial 9010 screen (pressing **ESC**), then press **Setup** (fifth function key from the top). Pressing the **RF OUT** button the receiver enters the RF Generator menu. Such **generator** is an internal, highly stable and accurate, 50 Ohm RF generator ranging from 10 Hz to 50 MHz. It is a CW signal source tuned at the frequency set under the **RF OUT Freq** window.

As usual, to set a given frequency it is therefore enough to edit the value with the soft keys and the left and right arrows, confirming the selections entering the units value (kHz, MHz or GHz). Pressing 0 as first figure the decimal dot appears automatically.

The output level can be set between 60,0 and 90,0 dBμV with 0,1dB steps using the **RF OUT Level** button. If a higher or lower level is needed, the User shall adopt either an external amplifier or an external attenuator.

With the PMM 9030/9060/9180 the **Tracking On** function is not available.



Using APD function, and in general when connecting PMM 9030/9060/9180, the **Tracking generator** function is not available.

13.6 Panel Save and Recall



If the user needs to save a certain configuration for the APD mode, it is possible to use the **PANEL** facility. To enter the Panel function it is necessary to go back to the initial 9010 screen (pressing **ESC**), then press **Setup** (fifth function key from the top). Then pressing the **PANEL** function key the User has access to the memory of the receiver and is allowed to store up to 2 different setups that can be recalled any time.

Pressing **Save #1** or **Save #2** the actual setup is stored in the internal memory; with the two **Recall** buttons the corresponding setup is loaded to the receiver.

Please remember each time one of the Save buttons is pressed, the stored set-up is overwritten by the new one: the saved setups are therefore kept memorized in the receiver until a new set-up is stored in the same memory.

The **Default** button can be used to load a default standard setup saved into the memory at the factory.



Turn Off the Internal Generator, when it is not used, even in APD mode. This prevents interferences and reduces the power consumption of the 9010 unit.

This page has been intentionally left blank



14 – Remote control

14.1 Introduction

PMM 9010 or PMM 9010/03P/30P/60P has been designed to allow remote control operations through its either RS232 or USB (Rear) ports. When using RS232 you can use only one instrument connected to PC serial port. If using USB you can connect other instruments to the free RS232 port and the PMM 9010 or PMM 9010/03P/30P/60P Receiver to the USB 2.0.

PMM 9010 or PMM 9010/03P/30P/60P uses the same commands protocol for both communications.

14.2 Communication

Half duplex communication is implemented. The RS232 port has a DB-9 female connector and the USB 2.0 has a USB-B connector.

A built-in automatic tool identify the type of communication used. Standard communication is implemented at 115200 (default), 38400, 9600 bit/sec with 8 bit words, one start bit, one stop bit and no parity (**115200 N 8 1**).

Rel 1.30 and later when supported by FPGA 0x1E and later supports also RTS/CTS Handshake.

14.2.1 RS 232 (Speed)

Under Setup menu, as described in chapter 3 of this manual, there is the RS232 speed selection.



Pressing the **Left** or the **Right Arrow** key, inside the Setup menu, the second page appears. In the second page is the RS 232 Port speed setting function.



Here it is possible to set the bit rate of the RS 232 serial port which connector is located on the rear panel.



The actual setting is always shown between the parenthesis and it is possible to choose between 9600, 38400 and 115200 bps.

The default speed, that is the one to be used for standard communication, is **115200**.

In case an optional device (ex. GPIB interface) is to be connected to the RS 232 port, refer to its operating manual to know the correct speed to be selected.

14.3 Protocol

Be aware that only the PC can send the commands. PMM 9010 or PMM 9010/03P/30P/60P will answer when is inquired only.

The communication uses strings with variable byte width. The characters used inside the strings are in ASCII format (00 - 127) at 7 bits. The most significant bits are ignored in reception and set to 0 during transmission. Every string starts with the special character “#” and stops with “*”.

14.4 Format

Commands are made of ASCII string delimited character “#” (0x23) and the character “*” (0x2A)

Replies are terminated with <CR><LF> (\r\n)



All the following examples are indifferently referred to the PMM 9010 or the PMM 9010/03P/30P/60P.

14.5 PMM 9010 COMMANDS Following are Commands to control and set various operating modes of PMM 9010, that can be distinguished in two main groups:

- Query Commands
- Setting Commands



NOTE

PMM 9010 and PMM 9010/03P/30P/60P can be remotely controlled also when it is connected to its options such as 9030/9060/9180 and Click meter Switching operation Box.



NOTE

A paragraph, at the end of this chapter, explains the differences in the protocol for the 9010F model.

14.6 List of commands

Query COMMANDS

Syntax	Function
?3PR*	Tells whether the apparatus is a PMM 9010/30P and in which mode
?AAT*	Requests the Attenuator status for Analyzer mode.
?ACE*	Requests the Center frequency for analyzer mode
?ADT*	Requests the detector used for Analyzer mode
?AHT*	Requests the Hold Time for Analyzer mode.
?AOP*	Requests the Stop frequency for analyzer mode
?APA*	Requests the Preamplifier status for Analyzer mode
?APS*	Requests the Preselector status for Analyzer mode
?ART*	Requests the Start frequency for analyzer mode
?ASP*	Requests the Span frequency for analyzer mode
?BAT*	Requests the battery voltage status.
?BCD*	Tells whether the Optic-Fibre Downconverter (3 GHz) is linked and ready
?CFA*	Sends back the ID of the conversion factor
?CKR*	Requests the complete record of a click Report
?CRA*	Tells whether RMS-AVG detector is available
?DET*	Reports the five detector for manual mode
?DMD*	Requests the status of demodulator.
?DMV*	Requests the volume of demodulator.
?DPY*	Sends back the bitmap of display hardcopy
?FSA*	Sends back a string expressing the number of Sweep Records available
?FSF n*	Requests the complete record
?IDN*	Requests model, release and date of firmware
?MAF*	Requests the tuning frequency for manual mode
?MAT*	Requests the Attenuator status for Manual mode
?MHF	Sends back a string expressing the Analyzer Max-Hold function STATUS
?MHP	Sends back a string expressing the Analyzer Max-Hold PAUSE Status
?MHT*	Requests the Hold Time for manual mode
?MIL*	Tells whether MIL Filters are available
?MPA*	Requests the Preamplifier status for Manual mode
?MPS*	Requests the Preselector status for Manual mode
?PLM*	Requests the Pulse Limiter status
?RBW*	Requests the selected RBW
?S/N*	Requests Serial Number internally stored by manufacturer
?SAT*	Requests the Attenuator status for Sweep mode
?SDT*	Requests the Detector used for Sweep mode
?SHT*	Requests the Hold Time for Sweep mode.
?SOP*	Requests the Stop frequency for Sweep mode
?SPA*	Requests the Preamplifier status for Sweep mode
?SPS*	Requests the Preselector status for Sweep mode
?SRT*	Requests the Start frequency for Sweep mode
?TAT*	Requests the MinAtt value
?TGF*	Requests the tuning frequency for the 9010 Built-In Generator
?TGL*	Requests the output level of 9010 Built-In Generator
?TGS*	Requests the 9010 Built-In Generator status
?TGT*	Requests the Tracking status of 9010 Built-In Generator
?UHT*	Requests the actual Hold Time currently or lastly used
?UPP*	Requests the status of input PINs of the User Port

Setting COMMANDS

Syntax	Function
ASBK	Aborts a sweep currently in progress
ASPA	Suspends a sweep currently in progress
ASRE	Resumes a sweep previously paused
S3PRC	Sets the PMM 9010/03P/30P/60P to conducted mode
S3PRR	Sets the PMM 9010/03P/30P/60P to radiated mode
SAAT a	Sets Attenuator for Analyzer Mode
SADT b	Sets the Detector for Analyzer Mode.
SAFF start,stop	Sets both Start and Stop frequency for Analyzer mode.
SAGO	Sets the 9010 in Analyzer mode
SAHT h	Sets Hold Time for Analyzer mode.
SAOP f	Sets the Stop frequency for Analyzer mode
SAPA a	Switches Preamplifier, for Analyzer Mode, On or OFF
SAPS a	Switches Preselector, for Analyzer Mode, On or OFF
SART f	Sets the Start frequency for Analyzer mode
SCFA n	Activates the conversion factor stored in the 9010
SCFE n, name	Saves the conversion factor (made by SCFW).
SCFW n, freq; lev	Creates a conversion factor frequency by frequency.
SDISDyn; RefLev;	Sets both Display Dynamic and Reference Level
SDMD a	Switches the Demodulator On or OFF
SDMV v	Sets the volume of Demodulator
SLDW n, freq; levq, leva	Sets the custom double value limit frequency by frequency
SLIC n, name	Names the custom limit and stores it onto the SoftKey
SLIE name	Name the custom limit and making it active or deactivating it.
SLII n	Recalls and loads into PMM9010 the built-in limit
SLIM n	Sets the Margin to be used with Smart Detector function
SLIW n, freq; lev	Sets the custom limit frequency by frequency
SMAF f	Sets the tuning frequency for manual mode
SMAN	Sets the 9010 in manual mode
SMANP	Sets the 9010 in manual mode and sets the default value
SMAT a	Sets Attenuator for Manual Mode.
SMHC	Clears the content of the Analyzer Max-Hold array
SMHF a	Enables the Analyzer Max-Hold function ON or OFF
SMHP a	Enables/disables the Analyzer Max-Hold Pause ON or OFF
SMHT h	Sets Hold Time for manual mode
SMPA a	Switches Preamplifier, for Manual Mode, On or OFF
SMPS a	Switches Preselector, for Manual Mode, On or OFF
SSDO	Triggers a sweep based on set parameters
SSDT b	Sets the Detector for Sweep Mode
SSFD	Sets parameters and triggers a sweep
SSFW n, freq	Creates a Frequency-Scan-Tab frequency by frequency
SSHT h	Sets hold time for Sweep mode.
SSOP f	Sets the Stop frequency for Sweep mode
SSPA a	Switches Preamplifier, for Sweep Mode, On or OFF .
SSPS a	Switches Preselector, for Sweep Mode, On or OFF
SPLM a	Switches the Pulse Limiter; On or OFF
SRBW b	Sets RBW
SSRT f	Sets the Start frequency for Sweep mode
SSTP	Stops abruptly a running sweep in Analyzer mode
STAT b	Sets MinAtt
STGF f	Sets the tuning frequency for 9010 Built-In Generator
STGL I	Sets the output level of 9010 Built-In Generator
STGS a	Switches the 9010 Built-In Generator On or OFF (a)
STGT a	Changes 9010 Built-In Generator tracking mode On or OFF
SUPP n	Outputs on the User Port bit by bit the argument n

14.6.1 QUERY

Commands	Description
?3PR	<p>This query command #?3PR * sends back a string expressing whether the apparatus is a PMM 9010/30P and in which mode. The reply is either:</p> <ul style="list-style-type: none"> • 3PR =CON (The PMM 9010/03P/30P/60P is ready for conducted frequency range) • 3PR =RAD (The PMM 9010/03P/30P/60P is ready for radiated frequency range) • 3PR=NUL (The PMM 9010/03P/30P/60P is not ready)
?AAT	<p>This query command #?AAT* sends back a string expressing the Attenuator status for Analyzer mode. The reply is made of 2 fields:</p> <ul style="list-style-type: none"> • AAT =AUTO (9010 automatically selects the most suitable attenuator to get best dynamic range) or AAT =MAN (operator selects manually the attenuator) • Value (in dB) of current attenuator <p>Example of reply: AAT =AUTO; 20 which means that the Attenuator is now switched to 20dB automatically by 9010</p>
?ACE	<p>This query command #?ACE* sends back a string expressing the Center frequency, in exponential notation, for analyzer mode. Unit is fixed MHz. Example of reply: ACE = 1.500000e+07 which means that the Center frequency in Analyzer mode is 15MHz</p>
?ADT	<p>This query command #?ADT* sends back a string expressing the detector used for Analyzer mode. The reply can be:</p> <ul style="list-style-type: none"> • ADT =Peak • ADT =Avg • ADT =Rms
?AHT	<p>This query command #?AHT* sends back a string expressing the HOLD TIME for Analyzer mode. Unit is fixed ms. Example of reply: AHT= 1000 ms which means that the hold time in Analyzer mode is 1000ms (or 1s)</p>
?AOP	<p>This query command #?AOP* sends back a string expressing the Stop frequency, in exponential notation, for analyzer mode. Unit is fixed MHz. Example of reply: AOP = 3.000000e+07 which means that the Stop frequency in Analyzer mode is 30MHz</p>
?APA	<p>This query command #?APA* sends back a string expressing the Preamplifier status for Analyzer mode. The reply is either:</p> <ul style="list-style-type: none"> • APA =Off (Preamplifier in Analyzer Mode is OFF) • APA =On (Preamplifier in Analyzer Mode is ON)
?APS	<p>This query command #?APS* sends back a string expressing the Preselector status for Analyzer mode. The reply can be:</p> <ul style="list-style-type: none"> • APS =Off (Preselector in Analyzer Mode is OFF) • APS =On (Preselector in Analyzer Mode is ON) • APS =*** (Preselector in Analyzer Mode is OFF because the span overlaps its single range)
?ART	<p>This query command #?ART* sends back a string expressing the Start frequency, in exponential notation, for analyzer mode. Unit is fixed MHz. Example of reply: ART = 1.500000e+07 which means that the start frequency in Analyzer mode is 15MHz</p>

- ?ASP** This query command **#?ASP*** sends back a string expressing the Spanfrequency, in exponential notation, for analyzer mode. Unit is fixed MHz.
 Example of reply: **ASP = 3.000000e+07** which means that the Span frequency in Analyzer mode is 30MHz
- ?BAT** This query command **#?BAT*** sends back a string containing the battery information. The format of replies in case of only 9010 or 9010/30P is:
BAT=V.vv;Flag
- While when a 9030 or 9060 is connected the reply is:
BAT=V.vv,U.uu; Flag
- Where **V.vv** is the voltage of 9010 battery and is expressed in Volt. When the 9010 is powered, **V.vv** becomes the string *******
- U.uu** is the voltage of 9030 or 9060 battery and is expressed in Volt.
- Flag** can have both '1' or '0' value and it is intended for knowing whether the value has been refreshed since it was last read. When Flag is '1' it means that the battery voltage has been updated while when it is '0' means that the value is the same as it was read before.
- Here are some example:
- **BAT=8.12,7.39;1** (9010 battery is 8.12V, 9030 battery is 7.39V and the values have been updated)
 - **BAT=8.12,7.39;0** (9010 battery is 8.12V, 9030 battery is 7.39V but the values have NOT been updated and thus they are the same as last reading)
 - **BAT=***;1** (9010 is powered and information is updated)
- ?BCD** This query command **#?BCD*** sends back a string expressing whether the Optic-Fibre Downconverter (3 GHz) is linked and ready. The reply is either:
- **BCD=Off** (The Downconverter is not available)
 - **BCD=Off;03P** (9010/03P connected)
 - **BCD=Off;30P** (9010/30P connected)
 - **BCD=Off;60P** (9010/60P connected)
 - **BCD=On** (The PMM9030 is ready)
 - **BCD=On ;9060** (The PMM 9060 is ready)
 - **BCD=On ;9180** (The PMM 9180 is ready)
- ?CFA** This query command **#?CFA*** sends back a string in the format **CFA=n,(LABEL)** where **n** is the ID of the conversion factor as shown in 9010 menu and **LABEL** is its temporary name as it was last labelled. If No conversion factor is active the reply is:
CFA= NONE
- Example of reply: **CFA=1,(PROBE)** means that conversion factor 1 is active and it was last named as PROBE
- ?CKR** This query command **#?CKR*** sends back the complete record of a click Report in the format as described in separate document.
 In case no records are available the reply is:
CKR= N/A
- ?CRA** This query command **#?CRA*** sends back a string telling whether RMS-AVG detector is available.
 Reply is:
- **CRA=N/A** if RMS-AVG detector is NOT available
 - **CRA=OK** if RMS-AVG detector is available

- ?DET** This query command **#?DET*** sends back a string reporting the five detector for manual mode. Unit is fixed dB μ V. Each value is separated by a semicolon. The order is Peak; Qpeak; RMS;AVG;C-RMS;C-AVG
In case Qpeak is not available (RBW other than 200Hz, 9kHz [only for Band B] ,120kHz) Qpeak field is replaced by the string "----".
In case C-RMS or C-AVG is not available (RBW other than 200Hz, 9kHz,120kHz,1MHz) respective field is replaced by the string "----".
- An additional string "OVER;" is appended at the end whenever an over range condition occurred
Example of reply: **DET=23.22;17.09;16.23;11.36,16.01,15.50;**
(which means Peak=23.22; Qpeak=17.09; RMS=16.23;AVG=11.36;C-RMS=16.01;C-Avg=15.50
Example of reply (No Cispr filter selected, over range shown):
DET=17.20;-----;11.98;9.57;-----;-----;OVER;
- ?DMD** This query command **#?DMD*** sends back a string expressing the status of demodulator. The reply is either:
- **DMD=Off** (The Demodulator is OFF)
 - **DMD =AM** (The Demodulator is On and demodulating AM)
- ?DMV** This query command **#?DMV*** sends back a string expressing the volume of demodulator. The reply is made of the string "**DMV=**" followed by the magnitude of volume ranging from 0 to 100
- **DMV=50** (The Demodulator Volume is 50)
- ?DPY** This query command **#?DPY*** sends back a the bitmap of display hardcopy
- ?FSA** This query command **#?FSA*** sends back a string expressing the number of Sweep Records available. The reply: **FSA= n: bands(1),Detector(1); bands(2),Detector(2);.....; bands(n),Detector(n)**
Where
- **n** is the number of records available.
 - Band (k) expresses the bands (or part of them) present in the sweep. k varies from 1 to n.
 - 0x01 --> Band A
 - 0x02 --> Band B
 - 0x04 --> Band C
 - 0x08 --> Band D
 - 0x10 --> Band E
 - Detector (k) expresses the Detector used t in the sweep. k varies from 1 to n
 - 0x0001 --> Peak
 - 0x0002 --> Avg
 - 0x0004 --> RMS
 - 0x0008 --> QPeak
 - 0x0010 --> C-Rms
 - 0x0020 --> C-Avg
 - 0x0200 --> Smart Avg
 - 0x0400 --> Smart RMS
 - 0x0800 --> Smart QPeak
 - 0x1000 --> Smart C-Rms
 - 0x2000 --> Smart C-Avg
- In case no records are available the reply is:
FSA= N/A
Example of reply:
FSA= 4:1,2049;3,2049;2,2049;1,1;

- ?FSF n** This query command **#?FSF n *** sends back the complete record in the format as described in separate document tagged as **n**. If **n =0** then the record is the one just measured.
 In case no records are available the reply is:
FSA= N/A
 Otherwise the 9010 sends a **Little Endian 32 bit long representing the size of the array** (see §14.6.4)
- ?IDN** This query command **#?IDN*** sends back a string containing information about model, release and date of firmware.
 Note that two <LF> are appended to the string before the terminator
 Example of reply: **IDN=9010-FW - 1.12 20/10/059<LF><LF>**
- ?MAF** This query command **#?MAF*** sends back a string expressing the tuning frequency, in exponential notation, for manual mode. Unit is fixed MHz.
 Example of reply: **MAF= 1.500000e+07** which means that the tuned frequency in manual mode is 15MHz
- ?MAT** This query command **#?MAT*** sends back a string expressing the Attenuator status for Manual mode. The reply is made of 2 fields:
 - **MAT=AUTO** (9010 automatically selects the most suitable attenuator to get best dynamic range) or **MAT=MAN** (the operator selects manually the attenuator)
 - **Value** (in dB) of current attenuator
 Example of reply: **MAT=AUTO; 20** which means that the Attenuator is now switched to 20dB automatically by 9010
- ?MHT** This query command **#?MHT*** sends back a string expressing the HOLD TIME for manual mode. Unit is fixed ms.
 Example of reply: **MHT= 1000 ms** which means that the hold time in manual mode is 1000ms (or 1s)
- ?MIL** This query command **#?MIL*** sends back a string telling whether MIL Filters are available.
 Reply is:
 - **MIL=N/A** if MIL Filters are NOT available
 - **MIL=OK** if MIL Filters are available
- ?MPA** This query command **#?MPA*** sends back a string expressing the Preamplifier status for Manual mode. The reply is either:
 - **MPA=Off** (Preamplifier in Manual Mode is OFF)
 - **MPA =On** (Preamplifier in Manual Mode is ON)
- ?MPS** This query command **#?MPS*** sends back a string expressing the Preselector status for Manual mode. The reply is either:
 - **MPS=Off** (Preselector in Manual Mode is OFF)
 - **MPS =On** (Preselector in Manual Mode is ON)
- ?PLM** This query command **#?PLM*** sends back a string expressing the Pulse Limiter status. The reply is either:
 - **PLM =Off** (Pulse Limiter is OFF)
 - **PLM =On** (Pulse Limiter is ON)

- ?RBW** This query command **#?RBW *** sends back a string expressing the selected RBW. The reply is made of 3 fields:
1. **RBW=AUTO** (9010 automatically selects the suitable RBW according to the tuned frequency) or **RBW=MAN** (Operator selects manually the RBW)
 2. **Id** identify the RBW as follows:
 - **1 →300kHz**
 - **2 →100kHz**
 - **3 →30kHz**
 - **4 →10kHz**
 - **5 →3kHz**
 - **Only for 9010**
 - **6 →9kHz (Cispr 16-1)**
 - **7 →200Hz (Cispr 16-1)**
 - **11 → 10kHz (MIL-STD-461) (only when available)**
 - **22 → 1kHz (MIL-STD-461) (only when available)**
 - **23 → 100Hz (MIL-STD-461) (only when available)**
 - **24 → 10Hz (MIL-STD-461) (only when available)**
 - **Only for Downconverter**
 - **9 →1MHz (Cispr 16-1)**
 - **10 →120kHz (Cispr 16-1)**
 - **12 →9kHz (Cispr 16-1)**
 3. **RBW NickName** (a mnemonic name)
- Example of reply: **RBW=AUTO 6 (9k_CISPR)** which means that selection is automatically made by 9010, the RBW id is 6 (**9kHz (Cispr 16-1)**). (**9k_CISPR**) is the nickname to quickly identify it
- ?S/N** This query command **#?S/N*** sends back a string containing serial number internally stored by manufacturer.
 Example of reply: **S/N=000WE50327**
- ?SAT** This query command **#?SAT*** sends back a string expressing the Attenuator status for Sweep mode. The reply is made of 2 fields:
- **SAT =AUTO** (9010 automatically selects the most suitable attenuator to get best dynamic range)
 - **Value** (in dB) of current attenuator
- Note: In Sweep mode the Attenuator is always forced to AUTO
- Example of reply: **SAT =AUTO; 20** which means that the Attenuator is now switched to 20dB automatically by 9010
- ?SDT** This query command **#?SDT*** sends back a string expressing the detector used for Sweep mode. The reply is made of several field representing the mode and, in case of smart detector function, the limit name and margin on which the smart detector is based:
- **SDT =Peak**
 - **SDT =Peak**
 - **SDT =Avg**
 - **SDT =Rms**
 - **SDT =C-Rms**
 - **SDT =C-Avg**
 - **SDT=Smart QPeak (CISPR 22-A +0dB)**
- ?SHT** This query command **#?SHT*** sends back a string expressing the HOLD TIME for Sweep mode. Unit is fixed ms.
 Example of reply: **SHT= 1000 ms** which means that the hold time in Sweep mode is 1000ms (or 1s)
 Note that the Hold Time is automatically changed when detector is set to Smart mode. In this case when the command SSdT is received the Hold Time = Min(Hold Time, 1000). If one wants to set it lower than 1000 in smart mode, the user should send the hold time command (SSHT) later than SSdT command.

?SOP	<p>This query command #?SOP* sends back a string expressing the Stop frequency, in exponential notation, for Sweep mode. Unit is fixed MHz. Example of reply: SOP = 3.000000e+07 which means that the Stop frequency in Sweep mode is 30MHz</p>
?SPA	<p>This query command #?SPA* sends back a string expressing the Preamplifier status for Sweep mode. The reply is either:</p> <ul style="list-style-type: none"> • SPA =Off (Preamplifier in Analyzer Mode is OFF) • SPA =On (Preamplifier in Analyzer Mode is ON)
?SPS	<p>This query command #?SPS* sends back a string expressing the Preselector status for Sweep mode. The reply can be:</p> <ul style="list-style-type: none"> • SPS =Off (Preselector in Analyzer Mode is OFF) • SPS =On (Preselector in Analyzer Mode is ON)
?SRT	<p>This query command #?SRT* sends back a string expressing the Start frequency, in exponential notation, for Sweep mode. Unit is fixed MHz. Example of reply: SRT = 1.500000e+07 which means that the start frequency in Sweep mode is 15MHz</p>
?TAT	<p>This query command #?TAT* sends back a string expressing MinAtt value. The reply is a string representing the minimum reachable value of attenuator in dB Example of reply: TAT=10 which means that MinAtt is 10dB</p>
?TGF	<p>This query command #?TGF* sends back a string expressing the tuning frequency, in exponential notation, for the 9010 Built-In Generator. Unit is fixed MHz. Example of reply: TGF = 1.500000e+07 which means that the tuning frequency for 9010 Built-In Generator (when is not tracking) is 15MHz</p>
?TGL	<p>This query command #?TGL* sends back a string expressing the output level of 9010 Built-In Generator. Unit is fixed dBμV. Example of reply: TGL = 90.0 which means that the output level of 9010 Built-In Generator is 90.0 dBμV</p>
?TGS	<p>This query command #?TGS * sends back a string expressing the 9010 Built-In Generator status. The reply is either:</p> <ul style="list-style-type: none"> • TGS=Off (9010 Built-In Generator is OFF) • TGS =On (9010 Built-In Generator is OFF)
?TGT	<p>This query command #?TGT* sends back a string expressing the Tracking status of 9010 Built-In Generator. The reply is either:</p> <ul style="list-style-type: none"> • TGT=Off (9010 Built-In Generator is no tracking but is tuned on a fixed frequency, set by STGF) • TGT =On ((9010 Built-In Generator is tracking the same frequency tuned on the receiver)
?UHT	<p>This query command #?UHT* sends back a string expressing the actual hold time currently or lastly used Example of reply: UHT=1.9ms</p>
?UPP	<p>This query command #?UPP* sends back a string expressing the status of input PINs of the User Port. Each Pin has its own contribution according to its index as follows: IN0= 2^0 IN1= 2^1 IN2= 2^2 IN3= 2^3 Thus, the number read back is the sum of each weighted contribution Example of reply: UPP= 5 means that user port pins IN0 and IN2 are high level while user port pins IN1 and IN3 are low-level</p>

14.6.2 SETTING Commands

Behaviour

ASBK	<p>This command aborts a sweep currently in progress previously started by command SSDO or SSFD. The reply is either:</p> <ul style="list-style-type: none"> • SBK=OK which means the sweep has been stopped and all setting commands are available again. In case the sweep was triggered by SSDO, with partial data, data are available for uploading by the command “?FSF 0” • SBK=SERR which informs that the sweep was not in need to be stopped
ASPA	<p>This command suspends a sweep currently in progress previously started by command SSDO or SSFD. There is no reply unless a sweep is not in progress in which case the reply is:</p> <ul style="list-style-type: none"> • SPA=SERR which informs that the sweep was not in need to be paused
ASRE	<p>This command resumes a sweep previously paused by command ASPA. There is no reply unless a sweep is not in progress in which case the reply is:</p> <ul style="list-style-type: none"> • SRE=SERR which informs that the sweep was not in need to be resumed
S3PRC	<p>This setting command #S3PRC* sets the PMM 9010/03P/30P/60P to conducted mode (BANDS A & B). The reply is:</p> <ul style="list-style-type: none"> • 3PR=OK (The PMM 9010/03P/30P/60P has been set for conducted mode) • 3PR =BERR (The command has been ignored for one of the following: <ul style="list-style-type: none"> • The connected apparatus is not a PMM 9010/03P/30P/60P • The instrument is not idling and therefore cannot switch to a different mode. In such an event, stop the current process (Manual, Analyzer or Sweep) and put it back to Idle. • 3PR =SERR (The command contains a syntax error)
S3PRR	<p>This setting command #S3PRR* sets the PMM 9010/03P/30P/60P to radiated mode (BANDS C for 9010/03P and BANDS C, D & E for 9010/30P). The reply is:</p> <ul style="list-style-type: none"> • 3PR=OK (The PMM 9010/03P/30P/60P has been set for radiated mode) • 3PR =BERR (The command has been ignored for one of the following: <ul style="list-style-type: none"> • The connected apparatus is not a PMM 9010/03P/30P/60P • The instrument is not idling and therefore cannot switch to a different mode. In such an event, stop the current process (Manual, Analyzer or Sweep) and put it back to Idle. • 3PR =SERR (The command contains a syntax error)
SAAT a	<p>This setting command sets Attenuator, for Analyzer Mode, to the value indicated by (a) which can be 0 to 35 (55). Automatic Attenuator feature is disabled. If (a) is a negative figure then the Automatic Attenuator feature is turned on. The reply is AAT=OK which acknowledges the command has been granted or AAT=SERR if the command has been ignored.</p> <p>Example: # AAT 15* (set attenuator to 15dB and disable Automatic Attenuator feature)</p> <p>Example: # AAT -1* (Enable Automatic Attenuator feature)</p>
SADT b	<p>This setting command sets the detector for Analyzer Mode. The argument (b) should be an index representing the detector as follows:</p> <ul style="list-style-type: none"> ○ 1 Peak ○ 2 Avg ○ 3 Rms <p>The reply is SADT =OK which acknowledges the command has been granted or SADT =SERR if the command has been ignored.</p> <p>Example: # SADT 1* sets the detector to Peak for Analyzer Mode</p>

- SAFF start,stop** This setting command sets both Start and Stop frequency for Analyzer mode. The strings (Start and Stop) can be in exponential form and should be expressed in Hz. The reply is **AFF=OK** which acknowledges the command has been granted or **AFF=SERR** if the command has been ignored.
- Example: **#SAFF 150e3,30e6*** Sets the Start frequency to 150kHz and Stop frequency to 30MHz for Analyzer mode
- SAGO** This setting command puts the 9010 in Analyzer mode. The reply is always **SAGO=OK**, which acknowledges the command has been granted, followed by an array, variable in size, representing the reply. Please refer to “**Analyzer Reply**” section for details of the response.
The 9010 goes to Analyzer mode.
- The 9010 goes to Analyzer mode.
Example: **#SAGO***
- SAHT h** This setting command sets hold time for Analyzer mode. The string (h) should be expressed in ms. The reply is **AHT=OK** which acknowledges the command has been granted or **AHT=SERR** if the command has been ignored.
Example: **#S AHT 1500*** Sets the hold time, for Analyzer mode, to 1500 ms (or 1.5s)
- SAOP f** This setting command sets the Stop frequency for Analyzer mode. The string (f) can be in exponential form and should be expressed in Hz. The reply is **AOP=OK** which acknowledges the command has been granted or **AOP=SERR** if the command has been ignored.
- Example: **#SAOP 10e6*** Sets the Stop frequency, for Analyzer mode, to 10MHz
- SAPA a** This setting command switches Preamplifier, for Analyzer Mode, according the parameter (a) which can be either **On** or **OFF**.
The reply is **APA=OK** which acknowledges the command has been granted or **APA=SERR** if the command has been ignored.
Example: **#S APA ON***
Example: **#S APA OFF***
- SAPS a** This setting command switches Preselector, for Analyzer Mode, according the parameter (a) which can be either **On** or **OFF**.
The reply is **APS=OK** which acknowledges the command has been granted or **APS=SERR** if the command has been ignored.
Example: **# APS ON***
Example: **# APS OFF***
- SART f** This setting command sets the Start frequency for Analyzer mode. The string (f) can be in exponential form and should be expressed in Hz. The reply is **ART=OK** which acknowledges the command has been granted or **ART=SERR** if the command has been ignored.
- Example: **#SART 150e3*** Sets the Start frequency, for Analyzer mode, to 150kHz
- SCFA n** This setting command activates the conversion factor stored in the 9010 (if any) where n is the ID of the conversion factor as shown in 9010 menu.
If n is not in the range 1 to 4 no conversion factor is active
The reply is:
CFA=OK (OFF) in case there is not active conversion factor
CFA=OK in case the conversion factor is active

**SCFE n, name**

This setting command is used for saving the conversion factor (made by **SCFW**). The command is made of the string:

- **FCE** (the command itself),
- **n** which is the index:
 - From 1 to 4 saves into permanent memory
 - 0 uses the factor temporarily
- **name** which is a string representing the name of it

This command is intended for creating a conversion factor into PMM9010. For further information see command **SCFW**.

When the command is received the conversion factor is checked and, if data (frequency and level) are coherent, the command is granted by replying **SCFW =OK** otherwise the replay is **SCFW =SERR**

Example: **#SCFE 2,Probe*** checks the data previously loaded by **SCFW** commands, names it as "Probe" and saves it as #2.

SCFW n, freq; lev

This setting command is used for creating a conversion factor frequency by frequency. It consists of three fields as follows:

- **n** Is the index of frequency being written and it should range from 0 to 499
- **freq** Is the frequency, expressed in Hz (exponential notation allowed), being written
- **lev** Is the level of the limit and is expressed in dB

The procedure to creating a conversion factor on PMM9010 is the following:

- Send as many commands as the frequency points of limit are in upwards order.
- Terminate (and make it active) by sending the command **SCFE**

Here is an example how to make a custom limit on PMM9010:

- **#SFCW 0, 150e3; -1 *** Send the first line 150kHz -1 dB
- **# SFCW 1, 500e3; 0 *** Send the second line 500kHz 0 dB
- **# SFCW 2, 5e6; 1.2 *** Send the third line 5MHz +2 dB
- **# SFCW 3, 50e6; 1.1 *** Send the fourth line 50MHz +1.1 dB
- **# SFCW 4, 300e6; 1 *** Send the fifth line 300MHz +1 dB

- **#SCFE 2,Probe*** Save it permanently as #2 into 9010 and name it as "PROBE"

Note that all the higher indexes in the conversion factor are cleared. Therefore, a conversion factor must be made upwards otherwise all points, having a higher index previously written, are cleared.

It is responsibility of the user to make sure the data sent are correct and coherent.

The reply is **SCFW =OK** which acknowledges the command has been granted or **LCFW =SERR** if the command has been ignored.

SDIS Dyn; RefLev;	<p>This setting command sets both Display Dynamic and Reference Level.</p> <p>Dyn represents the Display dynamic range shown And is expressed in dB. Value must be 80 ,100, 120.</p> <p>RefLevel represents the Display reference level (top of digram) shown end is expressed in dBμV. Value must can range from 65dBμV and 145dBμV. Note that reference level could be rounded by 9010 in order to best fit it.</p> <p>The reply is DIS=OK which acknowledges the command has been granted or</p> <ul style="list-style-type: none"> o DIS =ERR 1 when Dyn is else than 80,100 or 120. The command is ignored. o DIS =ERR 2 when RefLevel is out of range. The command is ignored. <p>The command reflects the settings for all three modes: Manual, Sweep and Analyzer.</p> <p>Example: #SDIS 100;110;*</p> <p>Sets the display dynamic to 100 dB and reference level to 110dBμV.</p>
SDMD a	<p>This setting command switches the Demodulator; according the parameter (a) which can be either On or OFF.</p> <p>The reply is DMD =OK which acknowledges the command has been granted or DMD =SERR if the command has been ignored.</p> <p>Example: # DMD ON* Example: # DMD OFF*</p>
SDMV v	<p>This setting command sets the volume of demodulator. The string (v) should be in the range of 0 to 100.</p> <p>The reply is DMV =OK which acknowledges the command has been granted or DMV =SERR if the command has been ignored.</p> <p>Example: #SDMV 50* Sets the volume of demodulator to half of the audio power.</p>
SLDW n, freq; levq, leva	<p>This setting command is used for setting the custom double value limit frequency by frequency. It consists of four fields as follows:</p> <ul style="list-style-type: none"> • n Is the index of frequency being written and it should range from 0 to 15 • freq Is the frequency, expressed in Hz (exponential notation allowed), being written • levq Is the level of the limit which refers to QPeak and is expressed in dBμV • leva Is the level of the limit which refers to the alternate detector and is expressed in dBμV <p>The purpose of this command is to have a double value limit that can be used along with smart detector function when sweeping by the command SSFD: The procedure to set a custom double value limit on PMM9010 is the following:</p> <ul style="list-style-type: none"> • Send as many commands as the frequency points of limit are in upwards order. • Terminate (and make it active) by sending the command SLIE <p>Here is an example how to make a custom limit on PMM9010:</p> <ul style="list-style-type: none"> • #SLDW 0, 150e3; 66,56 * Send the first line 150kHz 66 dBμV • #SLDW 1, 500e3; 56,46 * Send the second line 500kHz 56 dBμV • #SLDW 2, 5e6; 56,46 * Send the third line 5MHz 56 dBμV • #SLDW 3, 5e6; 60,50 * Send the fourth line 5MHz 60 dBμV • #SLDW 4, 30e6; 60,50 * Send the fifth line 30MHz 60 dBμV • #SLIE Custom Double * Send the name and make the limit active <p>Note that all the higher indexes in the limit are cleared. Therefore, a limit must be made in upwards order otherwise all points, having a higher index previously written, are cleared.</p> <p>It is responsibility of the user to make sure the data sent are correct and coherent.</p> <p>The reply is SLDW =OK which acknowledges the command has been granted or LDW =SERR if the command has been ignored.</p>

- SLIC n, name** This setting command is used for naming the custom limit and storing it onto the SoftKey.
 The command is made of
- **n** which is the index from 1 to 4 which saves into permanent memory
 - **name** which is a string representing the name of it
- This command is intended for making a custom limit into PMM9010. For further information see command **SLIW**.
 When the command is received the limit is checked and, if data (frequency and level) are coherent, the command is granted by replying **SLIC =OK** otherwise the replay is **SLIC =SERR**
- Example: **# SLIC 1, MyLimit*** checks the data previously loaded by **SLIW** commands, names the limit as “**MyLimit**” and stores it on SofKey 1
- SLIE name** This setting command is used for naming the custom limit and making it active or deactivating it. The command is made of the string **LIE** (the command itself) and a string which represents the name of the limit it will be shown. Sending a **LIE** with no argument (Limit name) deactivates all limit active, if any. This command is intended for making a custom limit into PMM9010. For further information see command **SLIW**.
 When the command is received the limit is checked and, if data (frequency and level) are coherent, the command is granted by replying **SLIW =OK** otherwise the replay is **SLIW =SERR**
- Example: **# SLIE Custom Limit*** checks the data previously loaded by **SLIW** commands, names the limit as “**Custom Limit**” and activates it
 Example: **# SLIE *** deactivates any limits
- SLII n** This setting command recall and load into PMM9010 the built-in limit indexed by n. The argument (n) should be a index representing the limit as follows:
- 0 □ "CISPR 22-A"
 - 1 □ "CISPR 22-B"
 - 2 □ "CISPR 14-1"
 - 3 □ "CISPR 14-2"
 - 4 □ "CISPR 14-3"
 - 5 □ "CISPR 14-4"
 - 6 □ "CISPR 11"
- Special index is as follows :
- -1 □ **Unloaded**
- The reply is **SLII =OK** which acknowledges the command has been granted or **SLII =SERR** if the command has been ignored.
 Example: **# SLII 1*** loads the limit □ "CISPR 22-B"
- SLIM n** This setting command sets the Margin to be used with Smart Detector function. The argument (n) in the range of -20 to 20.
 The reply is **LIM =OK** which acknowledges the command has been granted or **LIM =SERR** if the command has been ignored.
 Example: **#SLIM 2*** Sets the threshold of smart detector to 2 dB below the limit.

SLIW n, freq; lev	<p>This setting command is used for setting the custom limit frequency by frequency. It consists of three fields as follows:</p> <ul style="list-style-type: none"> • n Is the index of frequency being written and it should range from 0 to 31 • freq Is the frequency, expressed in Hz (exponential notation allowed), being written • lev Is the level of the limit and is expressed in dBμV <p>The procedure to set a custom limit on PMM9010 is the following:</p> <ul style="list-style-type: none"> • Send as many commands as the frequency points of limit are in upwards order. • Terminate (and make it active) by sending the command SLIE <p>Here is an example how to make a custom limit on PMM9010:</p> <ul style="list-style-type: none"> • #SLIW 0, 150e3; 66 * Send the first line 150kHz 66 dBμV • #SLIW 1, 500e3; 56 * Send the second line 500kHz 56 dBμV • #SLIW 2, 5e6; 56 * Send the third line 5MHz 56 dBμV • #SLIW 3, 5e6; 60 * Send the fourth line 5MHz 60 dBμV • #SLIW 4, 30e6; 60 * Send the fifth line 30MHz 60 dBμV <ul style="list-style-type: none"> • #SLIE Custom CISPR 14-1 * Send the name and make the limit active <p>Note that all the higher indexes in the limit are cleared. Therefore, a limit must be made in upwards order otherwise all point, having a higher index previously written, are cleared.</p> <p>It is responsibility of the user to make sure the data sent are correct and coherent. The reply is SLIW =OK which acknowledges the command has been granted or LIW =SERR if the command has been ignored.</p>
SMAF f	<p>This setting command sets the tuning frequency for manual mode. The string (f) can be in exponential form and should be expressed in Hz. The reply is MAF=OK which acknowledges the command has been granted or MAF=SERR if the command has been ignored.</p> <p>When the command is granted the 9010 goes to manual mode automatically</p> <p>Example: #SMAF150e3* Sets the manual frequency to 150kHz</p>
SMAN	<p>This setting command puts the 9010 in manual mode. The reply is always MAN=OK which acknowledges the command has been granted.</p> <p>The 9010 goes to manual mode.</p> <p>Example: #SMAN *</p>
SMANP	<p>This setting command puts the 9010 in manual mode and sets the default value to the following settings:</p> <ul style="list-style-type: none"> • RBW Automatic • Attenuator Automatic • MinAtt=10 dB • Preselector On • Preamplifier OFF • Hold Time =1000ms • Pulse Limiter = OFF • TG=OFF <p>The reply is always MANP=OK which acknowledges the command has been granted.</p> <p>The 9010 goes to manual mode.</p> <p>Example: #SMANP*</p>

- SMAT a** This setting command sets Attenuator, for Manual Mode, to the value indicated by (a) which can be 0 to 35 (55). Automatic Attenuator feature is disabled. If (a) is a negative figure then the Automatic Attenuator feature is turned on. The reply is **MAT=OK** which acknowledges the command has been granted or **MAT =SERR** if the command has been ignored.
 When the command is granted the 9010 goes to manual mode automatically.
 Example: **#SMAT 15*** (set attenuator to 15dB and disable Automatic Attenuator feature)
 Example: **#SMAT -1*** (Enable Automatic Attenuator feature)
- SMHT h** This setting command sets hold time for manual mode. The string (h) should be expressed in ms. The reply is **MHT=OK** which acknowledges the command has been granted or **MHT =SERR** if the command has been ignored.
 When the command is granted the 9010 goes to manual mode automatically.
 Example: **#SMHT 1500*** Sets the hold time, for manual mode, to 1500 ms (or 1.5s)
- SMPA a** This setting command switches Preamplifier, for Manual Mode, according the parameter (a) which can be either **On** or **OFF**.
 The reply is **MPA=OK** which acknowledges the command has been granted or **MPA =SERR** if the command has been ignored.
 When the command is granted the 9010 goes to manual mode automatically.
 Example: **#SMPA ON***
 Example: **#SMPA OFF***
- SMPS a** This setting command switches Preselector, for Manual Mode, according the parameter (a) which can be either On or OFF.
 The reply is **MPS=OK** which acknowledges the command has been granted or **MPS =SERR** if the command has been ignored.
 When the command is granted the 9010 goes to manual mode automatically.
 Example: **#SMPS ON***
 Example: **# SMPS OFF***
- SSDO**
SSDOC
SSDOD
SSDOE
- This command triggers a sweep based on set parameters. After this command has been received all parameters concerning the sweep are checked out and, if coherent, a sweep starts otherwise the related error is notified and the sweep is not triggered.
 The RBW is set to AutoCISPR. When in Downconverter Mode if the special case are issued the RBW is as follows:
- ☞ **SSDOC** --> Force to have 120kHz RBW Cispr throughout the sweep
 - ☞ **SSDOD** --> Force to have 120kHz RBW Cispr throughout the sweep
 - ☞ **SSDOE** --> Force to have 1 MHz RBW throughout the sweep
- During the sweep, for each step tuned, the PMM9010 sends a character 0x2E (".").
 At the end, if not aborted by as the command **ASBK**, the string "SWP_END" is sent to notify that the sweep has been done and available for uploading by the command "**?FSF 0**".
- NOTE** that all setting commands are ignored while the sweep is on while query commands are granted as well as the command **ASBK** which allows aborting the current sweep.
- The reply is
- **SDO=OK** if the sweep is started or
 - **SDO=ERR 1** if there is an error in start or stop frequencies
 - **SDO=ERR 2** if Smart detector is set but not active limit

SSDT b

This setting command sets the detector for Sweep Mode. The argument (b) should be a character representing the detector as follows:

- **P →Peak**
- **Q →QuasiPeak**
- **A →Avg**
- **R →Rms**
- **N →C-Rms**
- **C →C-Avg**

Optionally, the character 'S' may precede to activate the Smart Mode detector. Thus, if Smart Qpeak is desired the command should be **#SSDT SQ***

The reply is **SSDT =OK** which acknowledges the command has been granted or **SSDT =SERR** if the command has been ignored.

Example 1: **# SSDT P*** sets the detector to Peak for Sweep Mode

Example 2: **# SSDT SA*** sets the detector to Smart Average for Sweep Mode

SSFD
FreqStart;
FreqStop;
FreqStep;
Detector;
HoldTime;
Rbw;
MinAtt;
Preamp;
Preselector;
ScanHoldT

Note: Please look at §14.7 for further details related to FFT based units (i.e. 9010F)

Arguments are as follows:

- **FreqStart** = Sweep Start Frequency expressed in Hz
- **FreqStop** = Sweep Stop Frequency expressed in Hz
- **FreqStep** = Sweep Step Frequency expressed in Hz
 - If **FreqStep** > 0 then a standard sweep, tuned step by step, is made
 - If **FreqStep** < 0 (typical = -1) then the step will be set to AUTO
 - If **FreqStep** = 0 then the sweep will be made by tuning all the frequencies which are listed in Frequency-Scan-Tab (which it must have been written previously by command **SSFW**).
- **Detector**. In **non –smart mode**, any combination of the following detectors can be used and combined. All the detectors set will be measured and sent out. However, in **Smart Mode** only one detector at time, in addition to PEAK which is always present, can be set.
 - **Non Smart Mode** (All detectors can be indicated at once). Order is not important.
 - P →Peak
 - Q Peak
 - N C-Rms
 - A →Avg
 - R →Rms
 - C →C-Avg
 - **Smart Mode** (No more than 2 detectors can be indicated at once)
 - S → **Smart Mode** (this must be the first in the string)
 - Q Peak
 - N C-Rms
 - A →Avg
 - R →Rms
 - C →C-Avg
- **HoldTime** = Hold Time for each step and it is expressed in ms. Note that in case of Smart Mode HoldTime is used only when the disturbance is measured again by the alternative detector as minimum time, depending on the Rbw set, is used for the fast scan.
- **Rbw**. This is the index of Rbw to be used for the scan. Neither automatic selection, nor automatic switch is performed. The user must issue a suitable Rbw index. Index are as follows:
 - 1 →300kHz
 - 2 →100kHz
 - 3 →30kHz
 - 4 →10kHz
 - 5 →3kHz
 - **Only for 9010**
 - 6 →9kHz (Cispr 16-1)
 - 7 →200Hz (Cispr 16-1)
 - 11 → 10kHz (MIL-STD-461) (only when available)
 - 22 → 1kHz (MIL-STD-461) (only when available)
 - 23 → 100Hz (MIL-STD-461) (only when available)
 - 24 → 10Hz (MIL-STD-461) (only when available)
 - **Only for Downconverter**
 - 9 →1MHz (Cispr 16-1)
 - 10 →120kHz (Cispr 16-1)
 - 12 →9kHz (Cispr 16-1); No QPeak available

(Continued)

SSFD

FreqStart;

FreqStop;

FreqStep;

Detector;

HoldTime;

Rbw;

MinAtt;

Preamp;

Preselector;

ScanHoldT

- **MinAtt** = Minimum attenuation allowed during sweeping. This parameter ranges from 0 (no limitation) to the maximum the 9010/9030/9060/9180 or 9010/03P/30P/60P can set. This parameter is normally used to avoid switching up the sensitivity in order to either protect the input from high spikes or to prevent switching down the attenuation when, for instance, the limit is so high that it would be only waste of time.
Note: In Sweep mode the Attenuator is always forced to AUTO
- **Preamp.** This Parameter switches the Preamplifier On or Off according to its content as follows.
 - **On.** It turns ON the preamplifier.
 - **Off.** It turns Off the preamplifier.
- **Preselector.** This Parameter switches the Preselector On or Off according to its content as follows.
 - **On.** It turns ON the Preselector.
 - **Off.** It turns Off the Preselector.
- **ScanHoldT** = Hold Time used in Smart Mode when tuning for Peak for each step and it is expressed in ms. Note that this is used only in case of Smart Mode and not in standard sweep. This parameters is not compulsory and can be omitted if not required. I case it is not present, minimum time is taken.

This command triggers a free sweep (no automatic items are selected) based on the provided parameters. After this command has been received, all parameters issued in the command itself are checked out and, if coherent, a sweep starts otherwise the related error is notified and the sweep is not triggered.

Moreover, using the Frequency-Scan-Tab, the user has the capability of tuning only those frequencies which are suspected skipping thus the remainder. Hence, saving a lot of time.

After the command has been received, the 9010 replies by sending a string which reflects the status of parameter check as follows:

- **SFD=OK<RC><LF>** No error in parameters and sweep started.
- **SFD=ERR 1<RC><LF>** An Error was found in **start** or **stop** frequencies. Errors can be one of the following:
 - Start Frequency lower than minimum allowed frequency
 - Stop Frequency higher than maximum allowed frequency
 - Start Frequency higher than Stop Frequency
- **SFD=ERR 2<RC><LF>** An Error was found in **step** frequency. Step is either
 - Too small.
 - Is equal to zero (use of Frequency-Scan-Tab) but there are less than two frequencies in the table
- **SFD=ERR 3<RC><LF>** An Error was found in **detector**. Errors can be one of the following:
 - Invalid Detector or no detector found. Detectors must be indicated by 'P', 'Q', 'R', 'A', 'N' and 'S' only
 - Smart Mode selected but no active limit
 - Smart Mode selected but no alternative detector
 - Smart Mode selected but more than two alternative detector indicated



(Continued)

SSFD

FreqStart;

FreqStop;

FreqStep;

Detector;

HoldTime;

Rbw;

MinAtt;

Preamp;

Preselector;

ScanHoldT

- **SFD=ERR 4<RC><LF>** An Error was found in **HoldTime** value. **HoldTime** is either too big (>10s) or negative.
- **SFD=ERR 5<RC><LF>** An Error was found in **RBW**. Errors can be one of the following:
 - Unsuitable RBW for the active unit (for instance 200HZ Rbw while Downconverter is active)
 - Unsuitable RBW for the detector previously selected (for instance 100kHz Rbw and QuasiPeak selected).
- **SFD=ERR 6<RC><LF>** An Error was found in **MinAtt** value. Errors can be one of the following:
 - **MinAtt** value is negative
 - **MinAtt** value is higher than maximum available attenuation
 - **MinAtt** value is not in step of 5
- **SFD=ERR 7<RC><LF>** An Error was found in **Preamp** string. **Preamp** string can be either **ON** or **OFF** only. String is not case sensitive.
- **SFD=ERR 8<RC><LF>** An Error was found in **Preselector** string. **Preselector** string can be either **ON** or **OFF** only. String is not case sensitive.

Once the sweep is started, the 9010 sends the value of each detector chosen in the command. Each detector is made of a Little Endian 16 bit integer which represents the value of that tuned frequency. The value is expressed in **hundredth of dBm**. Therefore, for each step, there will be a packet of **n** detectors (**n** *2 bytes).

The order of detectors is fixed and is not related to the order issued in the command. For instance, PAQ is equivalent to QAP as well as RA is same as AR. The order of detector is as follows (from the first to the last):

1. Peak (which is always present)
2. QPeak (QuasiPeak)
3. RMS
4. AVG (Average)
5. C-RMS
6. C-AVG

Special meaning has the value **NOLEVEL**, **-32700** (Hex 8044), which informs that the detector has not been measured. This happens, for example, in Smart mode where the alternative detector is taken only for those frequencies the Peak was above the limit.

(Continued)

SSFD
FreqStart;
FreqStop;
FreqStep;
Detector;
HoldTime;
Rbw;
MinAtt;
Preamp;
Preselector;
ScanHoldT

FFT will be used, as opposed to standard sweep step by step, when the following conditions are matched:

- o Detector is either
 - o Peak (only) and HoldTime < 50ms or
 - o SMART and an alternate detector.
- o Stop frequency <= 150kHz
- o Span (Stop frequency - Start frequency) >= 5 kHz
- o Step frequency = 50Hz
- o RBW = 200Hz

After having terminated all steps and sent all data, the string **SFD_END<RC><LF>** is then sent informing the user there are no more data left. Any started sweep can be stopped by sending the command **ASBK** which abruptly terminates it.

In case the sweep was prematurely terminated by the command **ASBK**, the end of sweep (which will not contain all expected data) is **SBK=OK<RC><LF>**

Here is an example of the command:

#SSFD 1e6;10e6;10e3;PAR;0;6;10;OFF;ON*

Which triggers a sweep from 1 MHz to 10 MHz using a step of 5 kHz. Detectors are Peak, AVG and RMS. The hold time will be the minimum suitable (automatically adjusted by the unit). RBW is 9kHz. MinAtt is 10 dB which means that the attenuator will not switch below 10 dB attenuation. Preamplifier is OFF while the Preselector is turned on.

Here, for each step there will be a packet of 3 detectors per step (Peak, AVG and RMS in this order) counting thus 6 bytes (3 * 2) per step.

Here is another example:

#SSFD 9e3;150e3;50;SPQ;1000;7;10;OFF;ON;100*

Which triggers a sweep from 9kHz to 150kHz using a step of 50 Hz. Detector is Smart QuasiPeak using a hold time of 1s in re-measuring those frequencies which value was over the limit scanned using 100ms holdtime . RBW is 200Hz. MinAtt is 10 dB which means that the attenuator will not switch below 10 dB attenuation. Preamplifier is OFF while the Preselector is turned on.

In this case, as all the needed conditions are matched, FFT is used to perform the Peak scan.

Here, for each step there will be a packet of 2 detectors per step (Peak and QuasiPeak in this order) counting thus 4 bytes (2 * 2) per step. Of course, most of QuasiPeak value will be populated by **NOLEVEL** as QuasiPeak will be measured only for few frequencies (the ones which value is above the limit).

SSFW n, freq This setting command is used for creating a Frequency-Scan-Tab frequency by frequency. It is made of two fields as follows:

- **n** Is the index of frequency being written and it should range from 0 to 99
- **freq** Is the frequency, expressed in Hz (exponential notation allowed), being written

The procedure to make and use a Frequency-Scan-Tab on PMM9010 is the following:

- Send as many commands **SSFW** as frequency points of table are in upwards order.
- Send the command **SSFD** with step size set to zero

Here is an example how to make a Frequency-Scan-Tab on PMM9010:

- #SSFW 0, 150e3 * Set the first freq to 150kHz
- #SSFW 1, 500e3 * Set the second freq to 500kHz
- #SSFW 2, 5e6* Set the third freq to 5MHz
- #SSFW 3, 6e6* Set the fourth freq to 6MHz
- #SSFW 4, 30e6 * Set the fifth freq to 30MHz

Note that all the higher indexes in the Frequency-Scan-Tab are cleared. Therefore, a Frequency-Scan-Table must be made in upwards order. All points, having a higher index previously written, are cleared.

Note that only the present frequencies will be tuned and measured as all remaining will be completely neglected. Hence, it is **responsibility of the user to make sure** the data sent are correct and coherent.

The reply is **SSFW =OK** which acknowledges the command has been granted or **SSFW =SERR** if the command has been ignored.

SSHT h This setting command sets hold time for Sweep mode. The string (h) should be expressed in ms. The reply is **SHT=OK** which acknowledges the command has been granted or **SHT =SERR** if the command has been ignored.

Note that the Hold Time is automatically changed when detector is set to Smart mode. In this case when the command SSST is received the Hold Time = Min (Hold Time, 1000). If one wants to set it lower than 1000 in smart mode, the user should send the hold time command (SSHT) later than SSST command.

Example: **#SSHT 1500*** Sets the hold time, for Sweep mode, to 1500 ms (or 1.5s)

SSOP f This setting command sets the Stop frequency for Sweep mode. The string (f) can be in exponential form and should be expressed in Hz. The reply is **SOP=OK** which acknowledges the command has been granted or **SOP =SERR** if the command has been ignored.

Example: **#SSOP 10e6*** Sets the Stop frequency, for Sweep mode, to 10MHz

SSPA a This setting command switches Preamplifier, for Sweep Mode, according the parameter (a) which can be either **On** or **OFF**.

The reply is **SPA=OK** which acknowledges the command has been granted or **SPA =SERR** if the command has been ignored.

Example: **#SSPA ON***

Example: **#SSPA OFF***

SSPS a This setting command switches Preselector, for Sweep Mode, according the parameter (a) which can be either **On** or **OFF**.

The reply is **SPS=OK** which acknowledges the command has been granted or **SPS =SERR** if the command has been ignored.

Example: **#SPS ON***

Example: **#SPS OFF***

SPLM a This setting command switches the Pulse Limiter; according the parameter (a) which can be either **On** or **OFF**.
 The reply is **PLM =OK** which acknowledges the command has been granted or **PLM =SERR** if the command has been ignored.
 Example: **# PLM ON***
 Example: **# PLM OFF***

SRBW b This setting command sets RBW. The argument (b) should be a string representing the RBW as follows:

- **0 →RBW is Automatic** so that the 9010 automatically selects the suitable RBW according to the tuned frequency
- **1 →300kHz**
- **2 →100kHz**
- **3 →30kHz**
- **4 →10kHz**
- **5 →3kHz**
- **Only for 9010**
 - **6 →9kHz (Cispr 16-1)**
 - **7 →200Hz (Cispr 16-1)**
 - **11 → 10kHz (MIL-STD-461) (only when available)**
 - **22 → 1kHz (MIL-STD-461) (only when available)**
 - **23 → 100Hz (MIL-STD-461) (only when available)**
 - **24 → 10Hz (MIL-STD-461) (only when available)**
- **Only for Downconverter**
 - **9 →1MHz (Cispr 16-1)**
 - **10 →120kHz (Cispr 16-1)**
 - **12 →9kHz (Cispr 16-1) ; No QPeak available**

The reply is **RBW =OK** which acknowledges the command has been granted or **RBW =SERR** if the command has been ignored.
 Example: **#S RBW 3*** sets the RBW to 30kHz and disables Auto RBW mode
 Example: **#S RBW 0*** turn the RBW mode in Automatic

SSRT f This setting command sets the Start frequency for Sweep mode. The string (f) can be in exponential form and should be expressed in Hz. The reply is **SRT=OK** which acknowledges the command has been granted or **SRT =SERR** if the command has been ignored.
 Example: **#SSRT 150e3*** Sets the Start frequency, for Sweep mode, to 150kHz

SSTP This setting command stops abruptly a running sweep in Analyzer mode. The reply is always **STP=OK**, which acknowledges the command has been granted

STAT b This setting command sets MinAtt to the value indicated by (b) which range from 0dB to the maximum the 9010/9030/9060/9180 can set and must be in step of 5dB. The reply is **TAT=OK** which acknowledges the command has been granted or **TAT =SERR** if the command has been ignored.

Note: In Sweep mode the Attenuator is always forced to AUTO

Example: **#STAT 10***

STGF f This setting command sets the tuning frequency for 9010 Built-In Generator when is not tracking (STGT OFF). The string (f) can be in exponential form and should be expressed in Hz.
 Frequency should range between 1 kHz and 50MHz inclusive.
 The reply is **TGF=OK** which acknowledges the command has been granted or **TGF =SERR** if the command has been ignored.
 Example: **#STGF 150e3*** Sets the tuning frequency, for 9010 Built-In Generator, to 150kHz

- STGL I** This setting command sets the output level of 9010 Built-In Generator. The string (I) should be expressed in dB μ V.
 Level should range between 60 and 90 inclusive
 The reply is **TGL=OK** which acknowledges the command has been granted or **TGL=SERR** if the command has been ignored.
 Example: # **STGL 85.5*** Sets the output level of 9010 Built-In Generator to 85.5dB μ V.
- STGS a** This setting command switches the 9010 Built-In Generator; according the parameter (a) which can be either **On** or **OFF**.
 The reply is **TGS =OK** which acknowledges the command has been granted or **TGS =SERR** if the command has been ignored.
 Example: # **TGS ON***
 Example: # **TGS OFF***
- STGT a** This setting command changes 9010 Built-In Generator tracking mode; according the parameter (a) which can be either **On** or **OFF**.
 When tracking mode is ON the 9010 Built-In Generator is tuned on the same receiver frequency. When tracking mode is OFF the 9010 Built-In Generator is tuned frequency previously set by command STGF
 The reply is **TGT =OK** which acknowledges the command has been granted or **TGT =SERR** if the command has been ignored.
 Example: # **TGT ON***
 Example: # **TGT OFF***
- SUPP n** This setting command #**SUPP n*** outputs on the User Port bit by bit the argument n . Each Pin has its own contribution according to its index as follows:
- OUT0= 2⁰
 OUT1= 2¹
 OUT2= 2²
 OUT3= 2³
 SupplyOFF=2⁴
- Thus, the argument sent is the sum of each weighted contribution
 The reply is **UPP=OK** which acknowledges the command has been granted or **UPP=SERR** if the command has been ignored (IE argument >31).
- Example: **SUPP 5** will set:
- user port pins OUT0 and OUT2 to high level
 - user port pins OUT1 and OUT3 are low level
 - User Port Power Supply (+12V) ON

14.6.3 Analyzer Reply The PMM 9010 replies to the command “**SAGO**” sending back an array of bytes which contains all the information needed to draw a sweep. Typically, the user should first send the PMM 9010 all the setting commands to insure the receiver is correctly set on the wanted parameters and then read the reply. Just as an example, the user could send the following commands:

14.6.3.1 Reply example	#SAAT -1*	Set Attenuator Automatic mode
	#SAPA Off*	Switch Preamplifier OFF
	#SPLM a*	Switch Pulse Limiter OFF
	#SAFF 150e3,30e6*	Sets the Start frequency to 150kHz and Stop frequency to 30MHz
	#SAHT 2*	Sets the hold time to 2 ms
	#SADT 2*	Sets the detector to AVG
	More Command
	More Command
	#SAGO *	Start Sweep in Analyzer Mode



NOTE The PMM9010 replies by sending a 48 bytes header followed by a variable size array of integer (the size depends on frequency settings) as follows:

HEADER			
ID Byte	Value	Meaning	
1	A	The first 8 Bytes are just a fixed header and acknowledge the command	
2	G		
3	O		
4	=		
5	O		
6	K		
7	0x13 (CR)		
8	0x10 (LF)		
9	Start Frequency	Little Endian 32 bit Float figure representing the start frequency of sweep	
10			
11			
12			
13	Stop Frequency	Little Endian 32 bit Float figure representing the Stop frequency of sweep	
14			
15			
16			
17	Sep Frequency	Little Endian 32 bit Float figure representing the step frequency of sweep	
18			
19			
20			
21	Reserved	...	
...	...		
26	...		
27	Attenuator		Little Endian 16 bit integer representing the attenuator used
28			
29	Reserved	...	
...		
48			

<p>***** End of Header ***** (continued)</p> <p>From here all figures represent the level referred to the tuned frequency And are expressed in hundredth of dBm</p>		
49	Level Fstart	Little Endian 16 bit integer representing the level referred to start frequency.
50		
51	Level Fstart	Little Endian 16 bit integer representing the level referred to start frequency
52	+Fstep	plus step frequency
51	Level Fstart	Little Endian 16 bit integer representing the level referred to start frequency
52	+2*Fstep	plus 2 * step frequency
....
....
nn	Level Fstop	Little Endian 16 bit integer representing the level referred to Stop frequency
nn+1		



NOTE

The number of levels replied is calculated by the formula $1+(Fstop-Fstart)/Fstep$. However, because of the different approximation in managing floating point figures, please note that the number of received levels may slightly differ specially with big difference in (Fstop-Fstart).

It is always possible to terminate a sweep before its natural end by sending the command SSTOP.

14.6.4 Sweep Structure

The PMM 9010, in order to optimize memory, stores measures (sweeps) in dynamic mode. This means that a single sweep does not have a fixed size but it varies depending on the sweep itself. Moreover, in order to have a sweep made of different steps (as for example band A and band B), often sweeps are split into two single sweeps. Basically, the higher the span, the wider the size of sweeps. Here below there is a comprehensive description of the structure in which a sweep is stored by the PMM 9010.

The full structure is obtained by the reply to the command “**?FSF n**”.

The PMM9010 replies by first sending a **Little Endian 32 bit long representing the size of the array**, then a 512 bytes main header plus an additional 512 bytes sweeps header followed by a variable size array of integer (the size depends on frequency settings) as follows:

ID Byte	Mnemonic	Meaning
1	Size of data	Little Endian 32 bit long representing the size in byte of full sweep
2		
3		
4		

Main Header		
ID Byte	Mnemonic	Meaning
1	Start Frequency	Little Endian 32 bit Float figure representing the start frequency of full sweep
2		
3		
4		
5	Stop Frequency	Little Endian 32 bit Float figure representing the Stop frequency of full sweep
6		
7		
8		
9	NumSweep	Little Endian 16 bit integer representing the number of single sub-sweeps forming the full sweep
10		
11	Detector	Little Endian 16 bit integer representing the detector used
12		
13	Reserved	...
...	
498		
499	Conversion Factor	Null terminated string containing the name of the conversion factor used
...		
512		
***** End of Main Header *****		

Sweeps header		
Sweep #n		
ID Byte	Mnemonic	Meaning
513+(n-1)*32	Start Frequency Sub1	Little Endian 32 bit Float figure representing the start frequency of sub-sweep #1
514+(n-1)*32		
515+(n-1)*32		
516+(n-1)*32		
517+(n-1)*32	Stop Frequency Sub1	Little Endian 32 bit Float figure representing the Stop frequency of sub-sweep #1
518+(n-1)*32		
519+(n-1)*32		
520+(n-1)*32		
521+(n-1)*32	Step Frequency Sub1	Little Endian 32 bit Float figure representing the Step frequency of sub-sweep #1
522+(n-1)*32		
523+(n-1)*32		
524+(n-1)*32		
525+(n-1)*32	OffRec1	Little Endian 32 bit long representing the address of the array level of sub-sweep #1 This figure must be multiplied by 2
526+(n-1)*32		
527+(n-1)*32		
528+(n-1)*32		
529+(n-1)*32	LenRec1	Little Endian 32 bit long representing the size (in 16 bit words) of current sub-sweep #1 This figure must be multiplied by 2
530+(n-1)*32		
531+(n-1)*32		
532+(n-1)*32		
533+(n-1)*32	Detector Sub1	Little Endian 16 bit integer representing the detector used #1 The meaning of each individual bit is : <ul style="list-style-type: none"> ○ 0x0001 --> Peak ○ 0x0002 --> Avg ○ 0x0004 --> RMS ○ 0x0008 --> QPeak ○ 0x0010 --> C-Rms ○ 0x0020 --> C-Avg ○ 0x0200 --> Smart Avg ○ 0x0400 --> Smart RMS ○ 0x0800 --> Smart QPeak ○ 0x1000 --> Smart C-Rms ○ 0x2000 --> Smart C-Avg
534+(n-1)*32		
535+(n-1)*32	Reserved	
...
544+(n-1)*32		



Then, the arrays containing the level related to the tuned frequencies can be interpreted using the data OffRec and LenRec (respectively OffRec1, LenRec1 for sweep 1 and OffRec2, LenRec2 for sweep 2) as follows:

Level Array From here all figures represent the level referred to the tuned frequency And are expressed in hundredth of dBm		
OffRecn+1	Level Fstart Peak	Little Endian 16 bit integer representing the level referred to start frequency of sub sweep n .
OffRecn +2		
OffRecn +3	Level Fstart Alternate Detector	Little Endian 16 bit integer representing the level of the alternate detector referred to start frequency of sub sweep n .
OffRecn +4		
OffRecn +5	Level Fstart +Fstep	Little Endian 16 bit integer representing the level referred to start frequency of sub sweep n plus step frequency of sub sweep n .
OffRecn +6		
OffRecn +7	Level Fstart +Fstep Alternate Detector	Little Endian 16 bit integer representing the level of the alternate detector referred to start frequency of sub sweep n plus step frequency of sub sweep n .
OffRecn +8		
OffRecn +9	Level Fstart +2*Fstep	Little Endian 16 bit integer representing the level referred to start frequency of sub sweep n plus 2* step frequency of sub sweep n .
OffRecn +10		
OffRecn +11	Level Fstart +2*Fstep Alternate Detector	Little Endian 16 bit integer representing the level of the alternate detector referred to start frequency of sub sweep n plus 2* step frequency of sub sweep n .
OffRecn +12		
....
....
OffRecn + (2*LenRecn) +1	Level Fstop	Little Endian 16 bit integer representing the level referred to Stop frequency of sub sweep n .
OffRecn + (2*LenRecn) +2		
OffRecn + (2*LenRecn) +3	Level Fstop Alternate Detector	Little Endian 16 bit integer representing the level of the alternate detector referred to Stop frequency of sub sweep n .
OffRecn + (2*LenRecn) +4		



14.6.5 Procedure to read a measure stored by the PMM 9010

1. Send the command `#?FSF n *`.
2. Wait for the size of array
3. Wait for the first 1024 bytes in order to get both main and sweeps header
4. Read the relevant data concerning Start, Stop of full sweep as well as single sub-sweeps if they are more than one.
5. Go to the offset OffRec1 (OffRec1 *2) in the received buffer and read all the LenRec1 levels.
6. If the number of Sub-Sweeps is 2, go to the offset OffRec2 in the received buffer and read all the LenRec2 levels.
7. Next Address is (OffRec2+ LenRec1)*2

14.7 Special notes for 9010F

Programming differences between 9010 and 9010 Fast.

The communication protocol for PMM 9010F model is very similar to the one adopted for the 9010/03/30/60P family but with some improvements and extensions.

General

The query command `#?IDN*` sends back a string containing "9010F....." and information about release as usual.

Also the `?DPY` command, to download the bitmap image of the display, is slightly different.

Manual Mode

- The Demodulator is not activated. The reply is always DMD=OFF and the command should not be never sent even if OFF.

Analyzer Mode

- When the internal generator (TG) is in tracking mode, the unit is swept step by step
- **Be aware! To achieve the best performance, transfer data and process time must be fast enough to be congruent with 9010F.**

As the sweep data are contained in the header, the fact that the step used is different from the 9010 does not affect the interpretation of the data that remains the same.

Sweep Mode

- The internal generator (TG) can only be activated at a fixed frequency and no tracking.
- With SSFD command the step is always ignored and forced to AUTO (when step is > 0)
- Once the sweep is started, the 9010 **sends back an array of 32 bytes where the first 4 bytes are a Little Endian 32 bit floating point figure representing the step of sweep.** Then the value of each detector chosen in the command step by step will follow. Each detector is made of a Little Endian 16 bit integer which represents the value of that particularly tuned frequency. The value is expressed in hundredth of dBm. Therefore, for each step, there will be a packet of n detectors (n *2 bytes).
- The Smart Detector can not be used.

So, to summarize the commands:

?TGT, ?DMD, ?DMV, STGT, SDMD, SDMV, SSFW must not be used for the 9010F model.

The 9010F has the additional **SSFDS** command (the 9010 has the SSFD only); this command accept the step parameter (step > 0).

When using, instead, the SSFD command, the 9010F choses, automatically, the best step for the RBW in use, as an optimization.

Due to this added functionality, the protocol was adjusted, so that the receiver is able to communicate to the PC what the actual frequency step is.

The answer contains a header which format is the following:

After "SFD=OK\r\n" there are 32 bytes. The beginning 4 bytes represent the IEEE single Little Endian frequency step, in Hz.

The remaining 28 bytes are reserved and can be ignored.

14.7.1 Analyzer Max-Hold function The Analyzer Max-Hold function is mainly made of an array which is updated, whenever a new spectrum is available, to the maximum value between the previous and the current one.

14.7.1.1 Analyzer Max-Hold Activation This function can be activated at any time by the specific command “**SMHF ON**”. Similarly, it can be turned off using the complementary command “**SMHF OFF**”. When the Analyzer Max-hold function is operational, the spectrum sent over the serial communication shows the maximum value recorded, frequency by frequency, since the array was last cleared as opposed to the standard way which shows the most recent one. The related query command “**?MHF**” is implemented to check whether the Max-Hold function is active or not.

14.7.1.2 Analyzer Max-Hold Reset The array is initialized (cleared) when one of the following events happen:

1. Analyzer mode starts.
2. Any change of setting while in analyzer mode (I.E. a new RB or a different attenuator).
3. The command “**SMHC**” is issued.

When the array is cleared all previous data is lost and the first spectrum will populate the array (if not suspended).

14.7.1.3 Analyzer Max-Hold Pause (suspend) The process of updating the array can be temporarily suspended by using the command “**SMHP ON**” thus hanging the function and freezing its values. For the whole time span in which the PAUSE is ON, all new spectra will be discarded and consequently they will not influence the array content. Whenever the Pause is ON the spectrum, sent over the serial communication, shows the maximum value recorded up to the moment when the command “**SMHP ON**” was issued. To resume the Max-Hold Function the command “**SMHP OFF**” should be sent to the PMM 9010F. Note that when issuing the command “**SMHP ON**”, PAUSE is put to OFF thus the user does not have to concern about the state of it. The related query command “**?MHP**” is implemented to check whether the Max-Hold Pause is active or not.



NOTE

All Max-Hold commands should be issued when the spectrum has been completely received and before the next SAGO command.



NOTE

The Max-Hold function is implemented in the 9010F firmware from release 1.45 onwards. Please, update the internal firmware if necessary.

**14.7.1.4
 Analyzer MAX-
 HOLD related
 COMMANDS**

Query	
Command	Description
?MHF Max Hold Function	This query command ?MHF * sends back a string expressing the Analyzer Max-Hold function STATUS. The reply is either: <ul style="list-style-type: none"> • MHF=OFF. Analyzer Max-Hold function is disabled and the sent spectrum reflects the current one. • MHF=ON . Analyzer Max-Hold function is enabled and the sent spectrum reflects the maximum value recorded, frequency by frequency, since it was last cleared.
?MHP Max Hold Pause	This query command ?MHP * sends back a string expressing the Analyzer Max-Hold PAUSE Status. The reply is either: <ul style="list-style-type: none"> • MHP=OFF. Analyzer Max-Hold function is active and every new spectrum updates the maximum value. • MHP=ON . Analyzer Max-Hold function is paused (suspended). All incoming values will not influence the Max-Hold array content.

Setting	
Command	Description
SMHC Max Hold	This command clears the content of the Analyzer Max-Hold array. The reply is MHC=OK which acknowledges the command has been granted.
SMHF a Max Hold Function	This setting command enables the Analyzer Max-Hold function according to the parameter (a) which can be either ON or OFF . The reply is MHF=OK which acknowledges the command has been granted. When the command enables the Analyzer Max-Hold function it also disables the Analyzer Max-Hold PAUSE making it thus immediately active. #SMHF ON* . Analyzer Max-Hold function is enabled and the sent spectrum reflects the maximum value recorded, frequency by frequency, since it was last cleared. #SMHF OFF* . Analyzer Max-Hold function is disabled and the sent spectrum reflects the current one.
SMHP a Max Hold Pause	This setting command enables/disables the Analyzer Max-Hold Pause according to the parameter (a) which can be either ON or OFF . The reply is MHP=OK which acknowledges the command has been granted. When the Pause is ON no updates are made on the max-hold array. #SMHP ON* . Analyzer Max-Hold function is suspended: all incoming values will not influence the max-hold array contents. # SMHP OFF* . Analyzer Max-Hold function is enabled again: all max-hold array values are updated to the maximum value.

14.8 Sweep Mode commands sequence example

This is the sequence used by the PMM Emission Suite when a scantable is run, in the “conducted” range (from 9 to 11 MHz).

Example		
Command sent	Reply received	Description
#?IDN*		Queries information about model, release and date of the firmware
	IDN=9010/30P - 2.56 12/01/15	It is a 9010/30P with its FW
		It is used to check congruencies, frequency limits, and all the related characteristics
#?BCD*		Queries if a fibre optic device, like 9060 or 9180 is connected to the basic unit
	BCD=Off;30P	There are not fibre optic devices connected
		In case we know if the unit for high frequencies is connected and ready
#?S/N*		Queries the serial number
	S/N=010WX00610	Serial number
#?MIL*		Queries if MIL option is active
	MIL=OK	MIL option installed
		Extra RBW available
#?CRA*		Queries if RMS-AVG optional detector is active
	CRA=OK	RMS-AVG active
#SCFA -1*		Correction factors, if present, deactivated
	CFA=OK (OFF)	Important. Can be previously stored and activated by panel of from a previous setting
#SDIS120;120*		Sets display reference and dynamic. No effect on the measure
	DIS=OK	Ack
#SPLMOFF*		Switches off the internal pulse limiter
	PLM=OK	Pulse limiter off
#STGSOFF*		Switches off the internal TG. Could be on from a previous setting
	TGS=OK	ack
#?BAT*		Reads the battery level. Important if it is too low...
	BAT=7.66;1	It is 7.66V and it is a new reading
#S3PRC*		sets the unit in the bands A and B for conducted
	3PR=OK	ack
#SSFD		Sweep
9000000;11000000;5000;P;2;4;10;OFF;OFF;0*		
	Binary data reply	Measurements data
#?UHT*		Queries the hold time
	UHT=2.0ms	Applied hold time

This page has been intentionally left blank

15 – 9010F Fast



15.1 Introduction to PMM 9010F

The PMM 9010F(Fast) is a powerful EMI receiver, fully compliant to CISPR 16-1-1, intended for measuring conducted and radiated interferences from 10 Hz up to 30 MHz, or even up to 3/6/18 GHz when matched with PMM 9030/9060/9180 extension unit (optional, future implementation). All measurements performed by the PMM 9010F are according to the most accepted standards like: IEC, CISPR, EN (EuroNorm), FCC, VDE,...

The PMM 9010F design adopts an innovative philosophy made possible only in the recent years by the availability of superior technology components. This equipment is fully digital but the input preselector and attenuator – and, of course, the output stage of the internal reference generator - thus combining accuracy and reliability in an unique modern, user-friendly EMI receiver and signal analyzer.



Please refer to the other sections of this manual for the information not covered by this chapter and identical for the PMM 9010 model.

15.1.1 Principle of operation

Differently from PMM 9010, which is a digital sweeping receiver based on a zero-lock-time, step-by-step NCO (numeric controlled oscillator), fast settling time FIR RBW filters followed by digital detectors - something faster than conventional receivers anyway - the 9010F is a real-time gapless receiver based on FFT (Fast Fourier Transform) which evaluates N frequencies in a single shot.

Real time means that the FFT calculation must be as fast as the incoming data are sampled to achieve the result that no data are missed.

FFT itself would be not adequate for full compliant measurements without preventing:

- Aliasing effect, by adopting an appropriate input filter which suppresses the frequencies beyond the Nyquist limit.
- Spectrum leakage, due to the fact that observation of the input signal must be limited to a finite interval (an infinite series of subsequent finite intervals in our method). An appropriate time-windowing function is applied so that the spreading or leakage of the spectral components away from the correct frequencies is negligible.
- Picket fence effect, related to the resolution bias error that may cause in an FFT spectrum the peaks to be measured too low and the valleys too high in level. This phenomenon is avoided by adding a certain number of overlapped FFTs, calculated in parallel over almost the same input samples.

Thanks to these techniques the PMM 9010F has no gaps and detects any CISPR pulse even at the lowest repetition rates.

The 9010F processes 6 detectors x 1024 frequencies x 16 FFTs at once.

In this way it is possible, for example, to carry out a complete fully CISPR 16.1.1 compliant measurement with 2-second hold time over the A band (9 -150 kHz with a 200Hz RBW filter) in less than 8sec.

15.1.2 Instrument Items PMM 9010F includes the following items:

- EMI Receiver from 10 Hz up to 30 MHz
- BP-02 Li-ion battery pack;
- AC/DC Converter with plug adapters;
- Flexible black cover/accessories holding;
- BNC-BNC coaxial cable 2m length;
- RS232 cable, 2m;
- USB-RS232 serial converter;
- USB cable, 2m;
- Operating manual;
- PMM 9010 Utility Software on Software Media;
- Certificate of Compliance;
- Return for Repair Form.

15.1.3 Optional accessories

PMM 9010F can be used with several optional PMM accessories:

- PMM 9010-RMA Rack Mount Adapter for Rack 19"
- L1-150M: Single line LISN, 150A (50Ω//1 Ω+5μH);
- L2-16B: Two lines, Single phase, 16A LISN, (50Ω//5 Ω+50μH);
- L3-32: Four lines, 3-phase, 32A LISN, (50Ω//5 Ω+50μH);
- L3-64: Four lines, 3-phase, 64A LISN, (50Ω//5 Ω+50μH);
- L3-100: Four lines, 3-phase, 100A LISN, (50Ω//5 Ω+50μH);
- L1-500: Single line LISN, 300A LISN, (50Ω//5 Ω+50μH);
- L3-500: Four lines, 3-phase, 300A LISN, (50Ω//5 Ω+50μH);
- SBRF4 RF Switching Box (Switching Box for LISNs and Loop Antennas)
- SHC-1: 35 dB CISPR Voltage probe, 1500Ω;
- SHC-2: 30 dB CISPR Voltage probe, 1500Ω;
- RA-01: Rod Antenna (10 kHz – 30 MHz);
- VDH-01: Van der Hoofden Antenna (20 kHz – 10 MHz);
- GPIB to RS232 Adapter;
- Triple Loop Antenna

15.1.4 Other accessories Of course, the PMM 9010F can be used with other accessories available on the market, like:

- LISNs, any type;
- Antennas and Loops;
- Near Field Probes;
- Various TEM/GTEM Cells



Be sure not to overload PMM 9010F: the input signal should not exceed the maximum level indicated in the main specifications in chapter 1.

Also do not apply any signal to RF generator output connector.

15.1.5 Main Specifications

Table 15-1 lists the PMM 9010F performance specifications.
 The following conditions apply to all specifications:

- The ambient temperature shall be 0°C to 40°C

TABLE 15-1 Main Specifications

Frequency range	10 Hz to 30 MHz (CISPR-16-1-1 Full-Compliance from 9 kHz to 30 MHz)
Resolution	0,1 Hz
Frequency accuracy	< 1 ppm
RF input	Z _{in} 50 Ω, BNC fem.
VSWR	
≥ 10 dB RF att.	< 1.2
0 dB RF att.	< 1.6
Attenuator	0 dB to 35 dB(5dB steps)
Pulse limiter	Built in (selectable)
Preamplifier gain	20 dB (after preselector, selectable)
Max input level (without equipment damage)	
Sinewave AC voltage	137 dBμV (1 W)*
Pulse spectral density	97 dBμV/MHz
Preselector	
One lowpass filter	< 9 kHz
Six bandpass filters	9 kHz to 150 kHz 150 kHz to 5670 kHz 5.67 MHz to 11.19 MHz 11.19 MHz to 16.71 MHz 16.71 MHz to 22.23 MHz 22.23 MHz to 30 MHz
IF bandwidth	
6 dB bandwidth	1, 3, 10, 30, 100, 300 kHz
CISPR 16-1-1 bandwidth (6 dB)	0.2 and 9 kHz 10, 100 Hz and 1, 10 kHz (MIL-STD-461) ⁽¹⁾
6 dB bandwidth (with 9030, 9060 and 9180)	120 kHz and 1 MHz (CISPR 16-1-1) ⁽¹⁾ 100 kHz and 1 MHz (MIL-STD-461) ⁽¹⁾

(*) with MIN ATT ≥ 10 dB

Noise level

Preselector OFF, preamplifier OFF	9 to 150 kHz < -13 dBuV (QP 1s) (200 Hz RBW) < -16 dBuV (AV 1s)
	0.15 to 30 MHz < 5 dBuV (QP 1s) (9 kHz RBW) < 0 dBuV (AV 1s)
Preselector OFF, preamplifier ON	9 to 150 kHz < -27 dBuV (QP 1s) (200 Hz RBW) < -30 dBuV (AV 1s)
	0.15 to 30 MHz < -9 dBuV (QP 1s) (9 kHz RBW) < -14 dBuV (AV 1s)
Preselector ON, preamplifier OFF	9 to 150 kHz < -7 dBuV (QP 1s) (200 Hz RBW) < -10 dBuV (AV 1s)
	0.15 to 30 MHz < 5 dBuV (QP 1s) (9 kHz RBW) < 0 dBuV (AV 1s)
Preselector ON, preamplifier ON	9 to 150 kHz < -24 dBuV (QP 1s) (200 Hz RBW) < -27 dBuV (AV 1s)
	0.15 to 30 MHz < -7 dBuV (QP 1s) (9 kHz RBW) < -12 dBuV (AV 1s)

Spurious response

(PK 100ms) < -7 dBuV, < 3 dBuV above 150 kHz

Measuring Detectors

(Four simultaneous in stand-alone, all with PMM Emission Suite SW) Peak, Quasi-peak, Average, RMS, RMS-Average, C-Average, APD ⁽¹⁾.
Smart Detector function (with 9030, 9060 and 9180) ⁽¹⁾

Level measuring time

(Hold Time) 0.1 ms to 120 sec. (CISPR 16-1-1 as default)

Display units

Stand alone dBm, dBμV
(80 to 120 dB selectable dynamic)

With PMM Emission Suite SW on PC dBm, dBμV, dBμA, dBpW, dBμV/m, dBμA/m, dBpT
(80 to 200 dB selectable dynamic)

Spectrum

Span/division From 100 Hz to 3 MHz

Measurement accuracy

S/N > 20 dB
 10 Hz to 9 kHz ± 1.0 dB Typ
 9 kHz to 30 MHz ± 0.8 dB

Scan time
Sweep mode

(Full CISPR: preselector ON,
 QP detector)

A band
 (9 to 150 kHz) < 5 s (Hold time 1s)
 (200 Hz RBW) < 8 s (Hold time 2s)

B band
 (150 kHz to 30 MHz) < 20 s (Hold time 1s)
 (9 kHz RBW) < 38 s (Hold time 2s)

Analyzer mode
 (preselector OFF, Peak detector)

A band (9 to 150 kHz) < 0.45s (Hold time 100 ms)
 200 Hz RBW

B band (150 kHz to 30 MHz) < 1 s (Hold time 1 s)
 300 kHz RBW
 9, 10 kHz RBW (gapless) < 1 s (Hold time 50ms)

RF output

Tracking (manual mode) & CW generator
 Z_{out} 50 Ω , BNC fem.

Frequency range 10 Hz to 50 MHz
 Level range 60 to 90 dB μ V (0.1 dB step)
 Level accuracy (10 Hz to 30 MHz) 0.5 dB

Auto Calibration

Internal reference source

Stand-alone display and measure functions

Marker, marker peak, marker to center, highest peaks, move peak to Analyzer & Manual modes.

Store load:

- up to 11 traces (sweep mode)
- two panels
- 4 conversion factors

Built-in limits: CISPR 11, 14, 22.

Battery charge and voltage.

Display style, contrast, backlight.

Click functions (optional) ⁽¹⁾

I/O Interface Out

RS-232
 High speed Optical (2 channels)
 USB rear (front for future extension)
 User port (Drives PMM LISNs and accessories)
 IEEE-488 (optional)

Operating temperature	-5° to 45°C
Power supply	10 - 15 Volt DC, 2,5A; Li-Ion rechargeable and interchangeable battery (8h avg. duration) AC universal adapter/charger
Dimensions	235 x 105 x 335 mm
Weight	4.3 kg

Note (1): Soon available

15.1.6 Functional description

The PMM 9010F features a completely new receiver architecture based on the most recent DSP and FPGA technology:

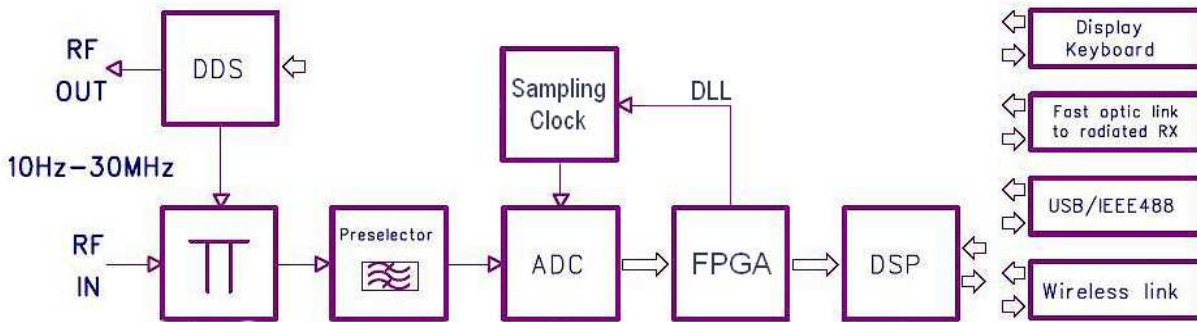

Fig. 15-1 PMM 9010F Functional BLOCK Diagram

15.1.7 Ultra fast measurement: a unique feature of the PMM 9010F

Scanning the CISPR band A (9 ÷ 150 kHz) and band B (150 kHz ÷ 30 MHz) may require very long time, even several hours. Thanks to its architecture, to the large internal memory and the built-in FFT capability, the PMM 9010F can take a “snapshot” of the whole band in a very short time and in full compliance with the CISPR requirements.

This feature greatly increases the productivity of the test laboratory, and allows more comprehensive analysis of intermittent disturbances with an irregular repetition rate.

According to the selected RBW, the whole spectrum or a portion of it is analyzed by FFT in sequence.

The following table shows spans related to RBWs

RBW	Real time Span [MHz]	Over FFT [times]
300 kHz	33.5	1
100 kHz	3.76	2
30 kHz	1.6	6
10 kHz	2	16
3 kHz	0.65	16
9 kHz Cispr	1.84	16
200 Hz Cispr	0.041	16

15.2 Sweep Mode



The **Sweep mode** is used to operate the PMM 9010F as a scanning EMI receiver. To enter this mode press the Sweep soft key on the main screen to set the parameters for the scan. All the automatic settings (RBW, frequency step, etc.) refer to the CISPR standard.

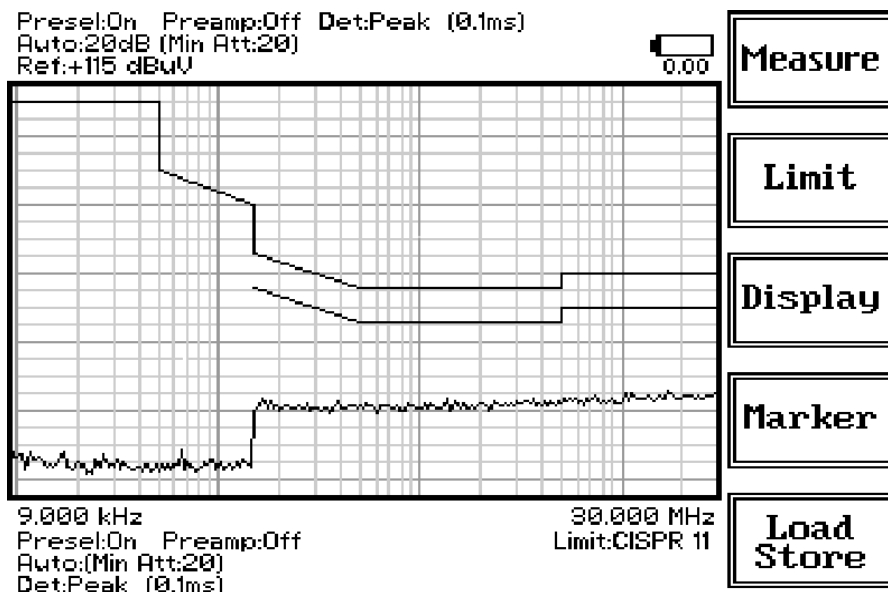

Fig. 15-2 Sweep

15.2.1 Ultra Fast FFT scan

The Ultra Fast FFT (Fast Fourier Transform), as described at §15.1.8, allows for assessing the EUT emissions across the whole spectrum in very short time and in full compliance mode, thus avoiding the preliminary debugging phases. The Ultra Fast FFT scan is also particularly suitable for those EUT that cannot stay ON for a long time without getting damaged (e.g. small electric motors, etc.) while maintaining the capability of performing a full-compliant Quasi-Peak evaluation of all the frequencies.

As for the Analyzer operating mode, all the relevant information are reported on the screen.

From the upper left corner, the User can see if the Preselector is ON or OFF; if the Preamplifier is ON or OFF; which detector is in use and the relevant hold time; if the input attenuation is Automatic or Manual and the set attenuation and if the Minimum attenuation is 0, 10 or 20 dB.

Just above the graph there is on the left the Reference level. During the scan, in the center above the graph the actual frequency measured and/or any other relevant operation.

Below the graph the start and the stop frequency, and loaded limits, if any.

When the sweep has been executed, on the bottom of the screen the most important sweep parameters are repeated.

If the graph has been loaded from the memory, just below the start frequency there is the symbol # followed by the memory position loaded (position number 2 in figure 4-1).

Please note that the information in the upper part above the graph refers to the next sweep to be done, while the information in the lower part, below the graph, concerns to the actual displayed data.



The Sweep mode function is divided into five sub windows:

- Measure
- Limit
- Display
- Marker
- Load Store

Always use Esc button to return to the previous view/condition.

15.2.2 Measure

The **Measure** button is used to set the scan parameters and to run the sweep.

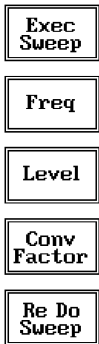

After having set the frequency band and the other parameters press the **Exec Sweep** button to run the sweep.

To make subsequent sweeps with the same setting parameters, simply press **ReDo Sweep**. This key is particularly useful to make comparisons e.g. before and after EUT modification after having loaded a previously stored track (see 4.6), as with the Re Do Sweep the original settings are kept for the new measurement.

Once the sweep starts, it can be stopped at any time during the execution by the **Stop** function key.

15.2.2.1 Frequency

The **Frequency** menu features five function buttons:

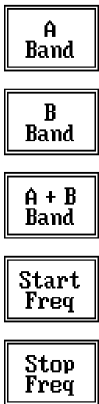

Pressing **A Band** the receiver will be set to scan the 9 - 150 kHz frequency band. The definition of band A is a given in CISPR.

Pressing **B Band** the receiver will be set to scan the 0,15 - 30 MHz frequency band. The definition of band B is a given in CISPR.

Pressing **A + B Band** the receiver will be set to scan the entire band from 9 kHz to 30 MHz.

In this way the Frequency Step and Resolution Bandwidth are set automatically according to CISPR standard requirement.

The **Start** and **Stop** frequency buttons can be used to set any frequency interval for the measurement; to enter the frequency values press the corresponding function keys.

Pressing either one of these 2 keys the figures 0, 1, 2, 3, and 4 are selectable at first; with the right arrow key it is possible to select the figures from 5 to 9, and pressing again the right arrow key the units kHz, MHz and GHz becomes accessible, as well as the decimal dot and the Back Space. The left arrow key can be used as well to move back and forth from one screen to the other. Pressing 0 as the first figure the decimal dot appears automatically.

To set a given frequency it is therefore enough to edit the value with the soft keys and the left a right arrows, confirming the selections entering the units value (kHz, MHz or GHz).

The figures entered appear in a small window just below the graph and the default unit is MHz.



15.2.2.2 Level



The Level function has 5 sub-menus, each one with several options..

Pressing the **Display** button it is possible to set two parameters: the visualized **Dynamic** range(chosen between 80, 100 and 120dB) and the **Reference Level**, that can be increased or reduced by steps of 5dB within the range +80 dBμV to 135 dBμV (-25 to +30 dBm).

The **Input** button opens a submenu which is dedicated to the setting of the input attenuator and to switch on-off the built-in preamplifier.

The PMM 9010F receiver takes automatically into account the settings of all the **Input** parameters and always displays the correct value of the level. The User is not required to make any correction to the readings.

15.2.2.3 Input:
Attenuators
and
preamplifier



Being entered in the Input submenu, to increase or decrease the attenuation at the input, press **Att +** or **Att -**, and for each touch the attenuation is increased or decreased of 5 dB (preset value). Depressing either one of these keys force the receiver in manual attenuation.

When the input attenuation is 0dB (condition that can be achieved only if the Minimum Attenuation is set to 0 dB as well), the yellow led to the left of the input BNC connector is ON and indicates a warning status.

The **Min Att** button acts as a toggle switch: it selects or deselects the minimum attenuation of 10 dB. When the minimum attenuation is selected, the attenuator – doesn't matter if in automatic or in manual condition - cannot be lowered under 10 dB.

Unless specifically required by the test conditions, do not remove the minimum attenuation of 10 dB.

With the **Preamp** key it is possible to insert or exclude the built-in low noise preamplification of 20 dB.

The internal 20 dB preamplifier can be used when very weak signals have to be investigated. As already mentioned, with the preamplifier ON the receiver automatically takes into account the 20 dB gain when measuring the signals.

The **Att Auto** button is used to switch from the two conditions of manual or automatic attenuation setting.

The “click” you may perceive is the auto-attenuator switching.



In case an OVERLOAD indication occurs it is necessary to add an external attenuator to carry on the measurement without overpassing the declared limit for continuous power or spectral density.

Using 0 dB attenuation PMM 9010F has no input protection.

This is a potentially dangerous condition for the input stage of the receiver.



Use 0 dB attenuation only if you are very sure that your input signal is less than 0.5 Vpp (or 106 dBμV).

Before to apply an unknown signal to PMM 9010F receiver, use an oscilloscope or a wide band RF voltmeter to measure it. In any case set Min. ATT at 10 dB and select the maximum available attenuation with preamplifier OFF.

If needed, add an external coaxial attenuator on the input signal line.

15.2.2.4 Misc



Under the **Miscellanea** functions menu it is possible to activate or exclude the **Preselector** filters, the **Pulse Limiter**, and also to enter in the **Tracking generator** menu pressing the **RF OUT** button.

The **Preselector** is composed by a group of filters automatically selected by the PMM 9010F while it is sweeping or anyway measuring. The aim of the preselector is to reduce the amount of out-of-band energy entering in the receiver, thus helping a lot in reducing intermodulation problems and similar undesired behaviors.

It can be set either ON or OFF with the associated button, and normally it should be always enabled.

On the top left corner of the screen the symbol "Off" or "On" will be displayed.

The **Pulse Limiter** is a very useful device to protect the input of the receiver from transient overvoltages. Doing conducted emission tests, quite often there are conducted disturbances (usually associated to switching operations in the EUT or along the line under test) which are too high and that propagates through the LISN up to the receiver. Sometime these disturbances cannot be seen on the receiver because they are out of measurement bandwidth, nevertheless the associate energy is high enough to damage the input attenuator and/or the Analog-to-Digital Converter of the PMM 9010F (the first mixer in a traditional receiver).

This pulse limiter has an integrated 10dB attenuator and a 30 MHz low-pass filter.

When the Pulse Limiter is selected, on the upper part of the screen the letters **P.L.** appear next the value of the Minimum Attenuation and the reading on the receiver is automatically corrected for the attenuation factor of the Pulse Limiter.

Pressing the **RF OUT** button the receiver enters the Tracking generator menu.

15.2.2.5 RF Output Generator



The **RF Output generator** is an internal, high stability and accuracy, 50 Ohm RF generator ranging from 10 Hz to 50 MHz.

NOTE: Due to the Ultra Fast FFT technology of the PMM 9010F the Tracking function is disabled; thus the generator consists of a CW signal source tuned at the frequency set under the **RF OUT Freq** window.

As usual, to set a given frequency it is enough to edit the value with the soft keys and the left and right arrows, confirming the selections entering the units value (kHz, MHz or GHz).

Pressing 0 as the first figure the decimal dot appears automatically.

The output level can be set between 60,0 and 90,0 dBµV with 0,1dB steps using the **RF OUT Level** button.

The internal generator is also used for self-calibration of the PMM 9010F.



NOTE

Turn Off the RF Output generator, if it is not used, while you are in Scan Mode.

This prevents interferences and the measurements are more clean and accurate.

15.2.2.6 Detector

This menu allows the operator to select the most appropriate **detector** for the test.

In Sweep mode the Peak, Average, RMS (Root Mean Square) and Quasi-Peak detectors are available and can be selected via the appropriate button.

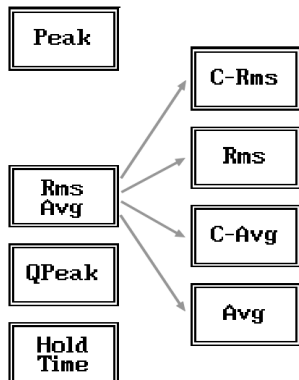

Hold time (ms)

The Hold Time (expressed in milliseconds) represents the time the receiver uses to “take a snapshot” of the incoming signal and to measure it with the chosen detector. When selecting a detector, the default hold time value is automatically loaded. In some cases e.g. when the interference signals have a low repetition rate setting a longer Hold Time may be necessary for preventing the auto-attenuator to continuously switching up and down

To set the **Hold Time** to the lowest possible value (this value dynamically depends from the measurement conditions), enter the figure 0; if a value lower than the allowed is entered, the lowest possible value is automatically selected.

The max. **Hold Time** that can be set is 120 sec.

15.2.2.7 Conversion factor

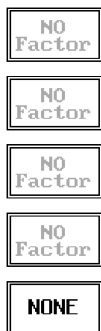

When using a transducer– a Voltage or Current Probe, an Antenna, etc. – its conversion factor must be added to the measured values.

The Conversion factor may also take proper account of losses as cable loss, attenuators added externally to the receiver, etc.

The PMM 9010F can handle these factors in an automatic way and directly correct the readings.

The PMM 9010F can store in its internal non-volatile memory up to 4 different correction factors, and use them one at a time when recalled.

However, the **Conversion Factors** shall be created and loaded via the PMM 9010F Software Utility.

Press the relevant button to load the conversion factor, and **NONE** to unload it.

15.2.3 Limit

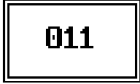
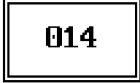

Each emission standard has one or more limits the User shall comply with. The PMM 9010F receiver has the possibility to load and activate one limit with a simple push of a button.

The preloaded standard limits refer to the most popular EMC emission standards: CISPR22, CISPR14 and CISPR11.

Other limits – or any custom designed limit – can be created, managed, selected and loaded through the PMM 9010F Software Utility running on a PC (and the test, of course, shall be handled via the PC software).

These additional custom limits cannot be stored in the memory of the PMM 9010F, but only in the one of the PC where the 9010FSW Utility is running.

The limits are shown on the scan display and they appear like a thin black line when the Smart Detector function is not enabled, while one of them appears in bold black when the Smart Detector function is active.

By pressing the NONE button all limits are deactivated.

15.2.4 Display

Pressing the **Display** button it is possible to set two parameters: the visualized **Dynamic** range(chosen between 80, 100 and 120dB) and the **Reference Level**, that can be increased or reduced by steps of 5dB within the range +80 dB μ V to 135 dB μ V (-25 to +30 dBm); see also 4.2.

15.2.5 Marker

Marker
OFF

Peak

Highest
7

Analyzer

Tune

Selecting this function a **Marker** is immediately enabled, and it appears on the screen as a small black pointing down arrow corresponding to the highest reading; simultaneously a small window shows up in the bottom left corner of the screen, indicating the actual frequency and level read by the marker.

The Marker function is not a simple search for the highest readings on the screen – it would be a useless exercise that would display a number of points all grouped together – but it’s a true peak search that measures the degree of variation of the signal: a peak is so classified only if it “pops-up” from the adjacent signals with at least 5 dB difference in amplitude. Following this criterion, if the measured signal is a flat line no peaks will be found.

Selecting **Highest X** – where X represents the maximum number of markers found by the receiver during its sweep – few more markers are added, each one “diamond” shaped, defined as per the previous explanation. The maximum number of markers available is 10.

By using arrow keys it is possible to quickly move on markers from higher amplitude (left arrow) to lower amplitude (right arrow), i.e. if the highest is selected, pressing the right arrow key the 2nd highest is selected, then pressing again the same key the 3rd highest and so on and so forth. It is also possible to use the rotary knob to move from a marker to the next one.

The marker under analysis (main marker) is a black arrow pointing down, the others are diamond shaped.

Pressing the **Peak** button the marker returns to the highest reading.

In order to make easier and faster the evaluation of the more noisy signals, the User can now select either the **Analyzer** or the **Tune** function, entering respectively into a spectrum analysis of main marker position or in the manual mode evaluation of it. To operate this two conditions please refer to the appropriate section of this Operating Manual.

In manual mode, i.e. having selected **Tune** on the main marker, it is possible to navigate from one peak to the other just pressing the arrow keys, without to come back to the Sweep display and remaining in manual mode.

This is another unique feature of PMM 9010F to improve the productivity of the test lab and make easier the work of the test engineer.

The **Marker Off** exits from the marker function.

15.2.6 Load Store



Pressing this key allows the User to have access to the memory of the receiver and enables the storing up to a number of different configurations/sweeps that depends on the parameters set on the receiver (i.e. the number of measured points). For example, using standard CISPR parameters it is possible to store up to 15 sweeps on the A+B band.

Each new scan will be stored in the first available memory position thanks to the button **Store #x**, where x is the first available position. When all positions are occupied by a scan, this function is disabled until one of the previous scan is erased.

To load a stored trace, press the **Load #x** button until the proper scan is displayed; to unload a trace select the **Unload Trace** button.

Please note that the Load function is scanning the memory in a circular way, therefore all the occupied memory positions are shown in sequence. When the key shows "Load #4", it means the trace #3 is displayed and that the #4 will be loaded after the key is pressed, and so on and so forth.

To erase a trace, press the **Erase#x** button.

Due to the structure of the memory, it is possible to erase only the latest stored memory, with a sequence "LIFO" (Last In First Out), therefore after having erased the #x, the #(x-1) will be the trace to be erased. With reference to the example at the left, the last stored trace is the #4, and it is the first that will be erased. After that, the key will show "Erase #3", and so on and so forth.

A more advanced trace management could be done using the PMM 9010F Software Utility.



Turn Off the RF Output generator, if it is not used, while you are in Scan Mode.

This prevents interferences and the measurements are more clean and accurate.



15.3 Analyzer Mode



To enter in the **ANALYZER Mode** press the Analyzer soft key on the main screen.

In this mode the receiver works as a Spectrum Analyzer maximizing the sweep speed.

The analysis is done at the selected span frequency.

The marker provides accurate measurement of the signals frequency and level.

Analyzer Mode display:

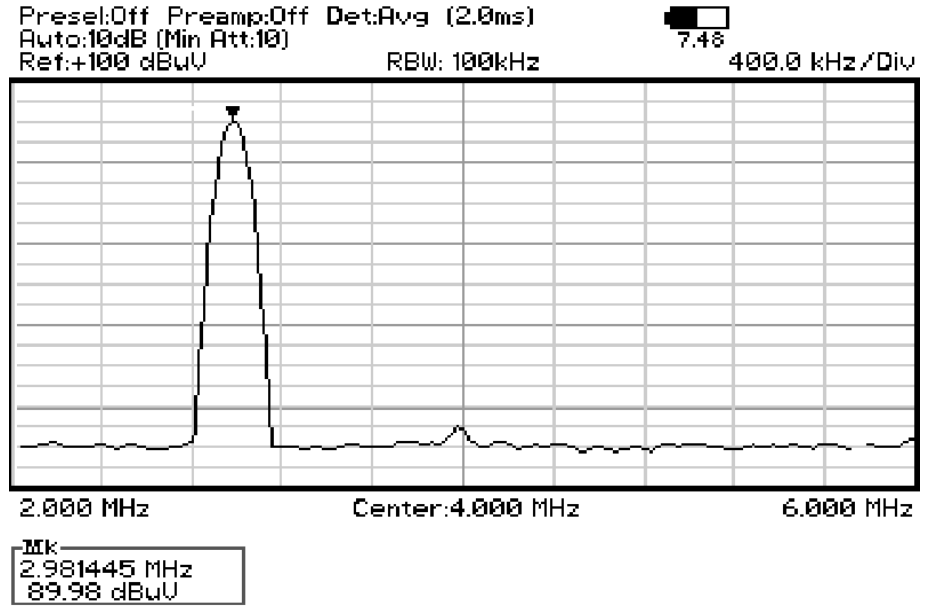

Fig. 15-3 Spectrum



The SPAN per division is automatically calculated over 10 divisions. The minimum SPAN is 100Hz per division.

On the screen of the Analyzer Mode all the relevant information are reported. From the upper left corner, the User can see if the Preselector is ON or OFF; if the Preamplifier is ON or OFF; which detector is in use and the relevant hold time; if the input attenuation is Automatic or Manual and the set attenuation and if the Minimum attenuation is 10 dB or 0dB.

Just above the graph, from left to right, there is the Reference level, the Resolution bandwidth and the span value.

Below the graph the start, center and stop frequency.

The bottom left corner is dedicated to the marker indication, with actual frequency and level of the marker.



The Spectrum mode function is divided into five sub windows:

- Frequency
- Resolution Bandwidth
- Level
- Marker
- Wide Mode

The fifth button is used to change the spectrum view to **wide screen mode**, as shown in the picture 5-1, and with the **Esc** button the original view can be restored.

Always use **Esc** button to return to the previous view/condition.

15.3.1 Frequency

Allows the User to set the tuning frequency and also the Span.



The **Center** frequency of the Spectrum window can be directly edited into the window or set by the arrow buttons or by the rotary knob, which frequency steps are set under the Manual mode.

Depressing the **Center** button the figures 0, 1, 2, 3, and 4 are selectable; with the right arrow key it is possible to select the figures from 5 to 9, and pressing again the right arrow key the units kHz, MHz and GHz becomes accessible, as well as the decimal dot and the Back Space. The left arrow key can be used as well to move back and forth from one screen to the other. Pressing 0 as the first figure the decimal dot appears automatically.

To set a given frequency it is therefore enough to edit the value with the soft keys and the left and right arrows, confirming the selections entering the units value (kHz, MHz or GHz).

The figures entered appear in a small window just below the graph and the default unit is MHz, so 100 kHz = 0,1 MHz; 10 kHz = 0,01 MHz; 1 kHz = 0,001 MHz and 100 Hz = 0,0001 MHz.

Using the **Start** and **Stop** buttons it is possible to select any start and stop value in the frequency range 10 Hz to 30 MHz band.

Another method for setting the frequency is to enter the **Center** frequency and the appropriate **Span**.

In this mode of operation the frequency step (spectrum resolution) is set automatically, therefore it cannot be changed manually.



In order to better analyze the signals close to the ends of the band and see them properly with any of the applicable filters, the receiver is able to go lower than 10 Hz and higher than 30 MHz.

The actual minimum frequency that can be displayed on the screen is 0 Hz, the maximum is 32 MHz.

15.3.2 RBW



The **Resolution Bandwidth** command is used to select the bandwidth of the measuring filter. Seven bandwidth filters are available:

- 200 Hz CISPR 16 shaped at -6dB
- 9 kHz CISPR 16 shaped at -6dB
- 1 kHz at -6dB
- 3 kHz at -6dB
- 10 kHz at -6dB
- 30 kHz at -6dB
- 100 kHz at -6dB
- 300 kHz at -6dB

The three larger filters are selectable from the first RBW screen, and pressing the **More RBW** button it is possible to select all the other filters. These filters are mathematically modeled using FIR (Finite Impulse Response) technique and they are exactly as required by the standards. More filters will be available as an option for specific applications, e.g. to cover Military Standards requirements, etc.

15.3.3 Level



The Level function has 5 sub-menus, each one with several options.

Pressing the Display button it is possible to set two parameters: the visualized Dynamic range (chosen between 80, 100 and 120dB) and the Reference Level, that can be increased or reduced by steps of 5dB within the range +70 dB μ V to 105 dB μ V (-35 to 0 dBm).

The Input button opens a submenu which is dedicated to the setting of the input attenuator and to switch on-off the built-in preamplifier.

The PMM 9010F receiver takes automatically into account the settings of all the Input parameters and always displays the correct value of the level. The User is not required to make any correction to the readings.

15.3.3.1 Input: Attenuators and preamplifier



Being entered in the Input submenu, to increase or decrease the attenuation at the input, press **Att +** or **Att -**, and for each touch the attenuation is increased or decreased of 5 dB (preset value). Depressing either one of these keys force the receiver in manual attenuation.

When the input attenuation is 0dB (condition that can be achieved only if the Minimum Attenuation is set to 0 dB as well), the yellow led to the left of the input BNC connector is ON and indicates a warning status.

The **Min Att** button acts as a toggle switch: it selects or deselects the minimum attenuation of 10 dB. When the minimum attenuation is selected, the attenuator – doesn't matter if in automatic or in manual condition - cannot be lowered under 10 dB.

Unless specifically required by the test conditions, do not remove the minimum attenuation of 10 dB.

With the **Preamp** key it is possible to insert or exclude the built-in low noise preamplification of 20 dB.

The internal 20 dB preamplifier can be used when very weak signals have to be investigated. As already mentioned, with the preamplifier ON the receiver takes automatically care of the 20 dB gain when measuring the signals.

The **Att Auto** button is used to switch from the two conditions of manual or automatic attenuation setting.

Please note that the switching of the attenuators is relatively noisy and you can perceive it distinctly with a "click" for each switch operation.

Using 0 dB attenuation PMM 9010F has no input protection. This is a potentially dangerous condition for the input stage of the receiver.



Use 0 dB attenuation only if you are very sure that your input signal is less than 1 V (or 120 dB μ V).

Before to apply an unknown signal to PMM 9010F receiver, use an oscilloscope or a wide band RF voltmeter to measure it. In any case set Min. ATT at 10 dB and select the maximum available attenuation with preamplifier OFF.

If needed, add an external coaxial attenuator on the input signal line.

15.3.3.2 OVER RANGE Message

An Over Range indication will automatically appear on the screen to inform the User that the levels of the measured signals in the spectrum window is too high: to avoid measuring errors and even damages to the receiver a higher attenuation shall be set.

15.3.3.3 Misc

Under the **Miscellaneous** functions menu it is possible to activate or exclude the **Preselector** filters, the **Pulse Limiter**, and also to set the **Tracking Generator**.



The **Preselector** is composed by a group of filters automatically selected by the PMM 9010F while it is sweeping or anyway measuring. The aim of the preselector is to reduce the amount of out-of-band energy entering in the receiver, thus helping a lot in reducing intermodulation problems and similar undesired behaviors.

In Analyzer mode the preselector is available only if the entire span falls in one filter band (see the main specification in chapter 1 to verify the frequency bands). In this situation on the display it will be shown: Preselector ON. If the span is larger than one filter only, on the display the symbol *** will appear instead.

It can be set either ON or OFF with the associated button, and normally it should be always enabled.

On the top left corner of the screen the symbol "Off" or "On" will be displayed.

The **Pulse Limiter** is a very useful device to protect the input of the receiver from transient overvoltages. Doing conducted emission tests, quite often there are conducted disturbances (usually associated to switching operations in the EUT or along the line under test) which are too high and that propagates through the LISN up to the receiver. Sometime these disturbances cannot be seen on the receiver because they are out of measurement bandwidth, nevertheless the associate energy is high enough to damage the input attenuator and/or the Analog-to-Digital Converter of the PMM 9010F (the first mixer in a traditional receiver).

This pulse limiter has an integrated 10dB attenuator and a 30 MHz low-pass filter.

When the Pulse Limiter is selected, on the upper part of the screen the letters P.L. appear next the value of the Minimum Attenuation and the reading on the receiver is automatically corrected for the attenuation factor of the Pulse Limiter.

Pressing the **RF OUT** button the receiver enters the Tracking generator menu.

15.3.3.4 Tracking generator

**RF OUT
Freq**

**RF OUT
Level**

**Tracking
OFF**

**RF OUT
On Off**

The **tracking generator** is an internal, high stability and accuracy, 50 Ohm RF generator ranging from 10 Hz to 50 MHz.

Activating the **Tracking On** function the generator is always tuned at the same PMM 9010F measurement frequency and scans the range together with the receiver. This is the standard way a tracking generator works in all spectrum analyzers.

If the Tracking On function is disabled, the generator becomes a CW signal source tuned at the frequency set under the **RF OUT Freq** window.

As usual, to set a given frequency it is therefore enough to edit the value with the soft keys and the left and right arrows, confirming the selections entering the units value (kHz, MHz or GHz).

Pressing 0 as the first figure the decimal dot appears automatically.

In both operating modes (tracking or fixed frequency) the output level can be set between 60,0 and 90,0 dB μ V with 0,1dB steps using the **RF OUT Level** button.

If a higher or lower level is needed, the User shall adopt either an external amplifier or an external attenuator.

The tracking generator is extremely useful for several applications: first of all it is essential to calibrate the receiver itself thanks to the automatic internal routines specifically developed to this extent, then it can also be used to transform the PMM 9010F in a scalar network analyzer, helping a lot in designing and testing RF filters, active stages and a lot of other circuits.

15.3.3.5 Detector

Peak

Avg

RMS

**Hold
Time**

This menu allows the Operator to select the most appropriate **detector** for the test.

In Analyzer mode the Peak, Average and RMS (Root Mean Square) detectors are available and can be selected via the appropriate button.

Hold time

The Hold Time (expressed in milliseconds) represents the time the receiver uses to “take a snapshot” of the incoming signal and to measure it with the chosen detector. When selecting a detector, the default hold time value is automatically loaded, but in some cases this time is not appropriate, e.g. when the interference signals have a low repetition rate. In this case the PMM 9010F sees a high input signal and therefore tries to set the proper attenuation automatically increasing the value or the input attenuators. However, when the input attenuation is set the signal is gone, so the receiver lowers the attenuation, but then a new peak arrives, and so on and so forth..

On the other hand, if the **Hold Time** is too high the PMM 9010F cannot properly follow the signals.

In this situation the Hold Time value should be manually set to find a correct compromise.

To set the **Hold Time** to the lowest possible value (this value dynamically depends from the measurement conditions), enter the figure 0; if a value lower than the allowed is entered, the lowest possible value is automatically selected.

The max. **Hold Time** that can be set is 120 sec.

15.3.3.6 Conversion factor



When using a transducer to make a measurement – a Voltage or Current Probe, an Antenna, etc. – there is always the need to add to the measured values the conversion factor of the transducer in use.

The Conversion factor may also take proper account of losses as cable loss, attenuators added externally to the receiver, etc.

The PMM 9010F can handle these factors in an automatic way and directly correct the readings.

The PMM 9010F can store in its internal non-volatile memory up to 4 different correction factors, and use them one at a time when recalled.

However, the **Conversion Factors** shall be created and loaded via the PMM 9010F Software Utility.

Press the relevant button to load the conversion factor, and **NONE** to unload it.

15.3.4 Marker



With this command the **Marker** function can be enabled.

Switching ON the marker it appears on the screen as a small black pointing down arrow, and simultaneously a small window shows up in the bottom left corner of the screen, indicating the actual frequency and level read by the marker.

Pressing the **Peak** button the marker will automatically move to the highest signal found in the span range in that given moment, and with the help of the **Center** button the frequency selected by the marker becomes the center frequency on the screen, making very easy any signal analysis.



ESC : This button allows to return to the previous view or condition.

Annex - A

RMS-AVG and C-AVG Detectors



All the following examples are indifferently referred to the PMM 9010 or the PMM 9010/03P/30P/60P.

A-A.1 Introduction

PMM 9010 has been designed to allow the use of many kinds of detectors. CISPR Standard has introduced the application of two detectors that are derived from the Root Mean Squared and from the Average ones. To have these two additional detector available it is recommended the upgrade of the Unit to a Firmware revision 1.85 or following.

Please refer to chapter 8 of the User's Manual to find the instructions concerning how to upgrade the internal firmware.

The present Annex provides information needed to use the added firmware functions both for PMM 9010 and for PMM 9030/9060/9180 extension.

A-A.2 RMS-AVG Definition

The RMS-Average detector is a payment special function implemented in the PMM 9010 receiver.



RMS-Average detector is manufactured under license of Rohde & Schwarz GmbH & Co. KG.

The RMS-Average detector, according to the CISPR 16-1-1 standard, supplies a reading of the input signal that is weighted, for repeated pulses, such that for a constant indication, the relationship between amplitude and repetition frequency is in accordance with the following rule:

the Amplitude is proportional to (repetition frequency)^{-1/2}

The value is the maximum level during the measurement time (Hold Time) and the averaging is carried out with a lowpass filter of the 2nd order to simulate a mechanical instrument.

The calibration is in reference to the RMS value of an unmodulated sinewave signal.

A.A.3 RMS-AVG Activation Procedure (option)

To enable the RMS-AVG Detector use the 9010 Set code Utility.



For further information on software installation refer to the "Updating firmware and Activation code Utility" chapter.

Click on "9010 Set code Utility" (WrDongle.EXE) once for running the Set code program, so getting the following window:

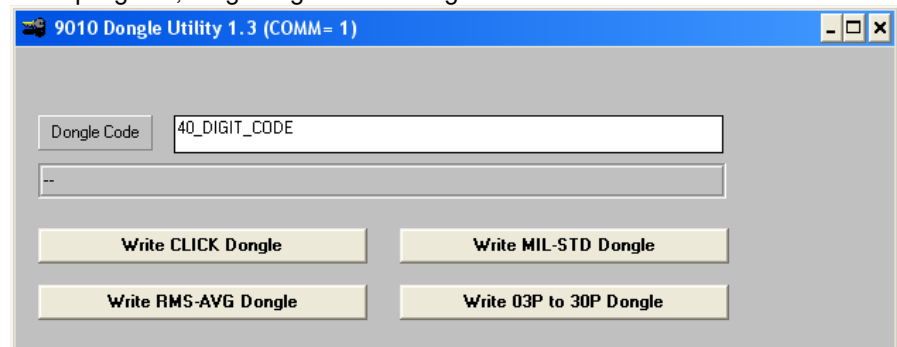

Copy the 40 Digit Serial Code in the Dongle Code Window and select the **Write RMS-AVG Dongle** button.

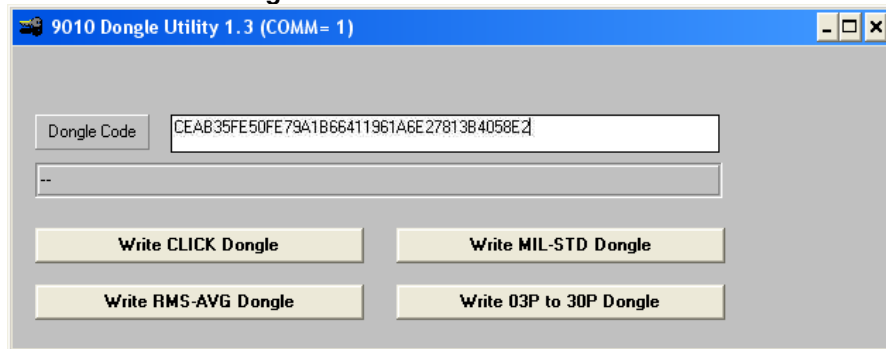

This message appears when the Dongle code is not valid.



It will be shown the following message; press OK to confirm.

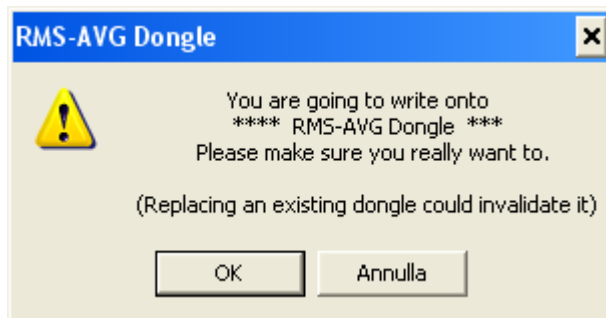

The software will inform that the Dongle Code has been successfully stored. Press Ok to close the program.



**A-A.4 C-AVG**
Definition

CISPR 16-1-1 defines the Average detector as designed to indicate the weighted average value of the maximum value of the envelope of the signal passed through the pre-detector stages:

up to 1000 MHz, is defined as the response of the measuring receiver to pulses of repetition rate n Hz and impulse area of $1,4/n$ mVs emf at 50Ω source impedance that shall be equal to the response to an unmodulated sine-wave signal at the tuned frequency having an emf with rms value of 66 dB μ V.

The value of n shall be 25 for Band A, 500 for Band B, and 5000 for Bands C and D.

For the frequencies over 1 GHz the value of n shall be 50 000.

The average detector is useful to measure narrowband signals to overcome problems associated with either modulation content or the presence of broadband noise.

When the Average is measured according to CISPR 16-1-1, the maximum value of the linear mean envelope during the measurement interval is shown. The detector is used, for example, to measure pulsed sinusoidal signals with a low pulse repetition rate. It is calibrated with the rms value of an unmodulated sinewave signal. Averaging is carried out with lowpass filters of the 2nd order (simulating a mechanical instrument).



Be sure not to overload PMM 9010: the input signal should not exceed the maximum level indicated in the main specifications in chapter 1. Also do not apply any signal to RF generator output connector.

A-A.5 Sweep Mode



The **Sweep mode** is used to operate the PMM 9010 as a powerful scanning EMI receiver. To enter in this mode it's enough to depress the Sweep soft key on the main screen, and immediately the scan setup window pops up and allows the operator to set the parameters for the scan. All the automatic settings (RBW, frequency step, etc.) refer to the CISPR standard. In Sweep mode the Peak, QPeak, C-Rms, RMS, C-Avg, Avg detectors are available.

A-A.5.1 Detector selection

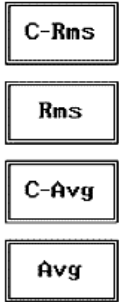
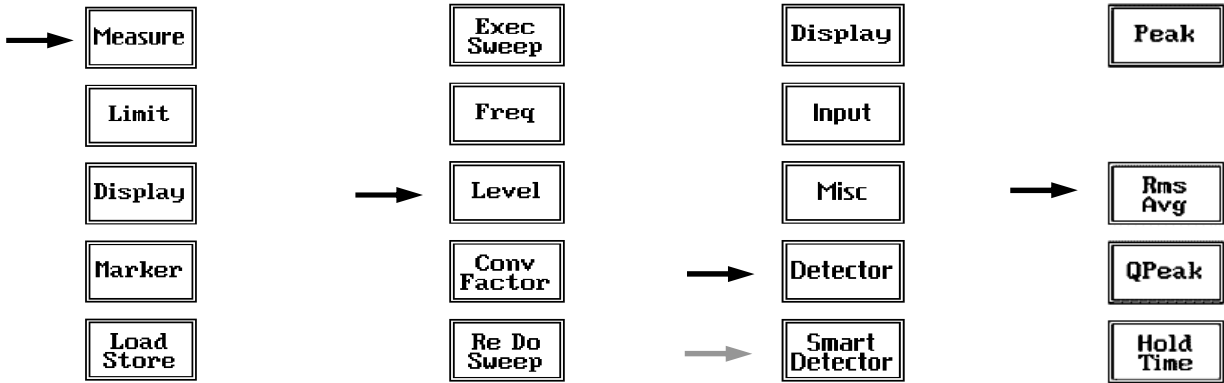

To select the desired detector, from the main **Sweep menu**, enter the **Measure** setup, then press the soft-keys labeled **Level**, **Detector** and choose the proper one.

Pressing the **Rms/Avg** key these four more detectors are available.

A-A.5.2 Smart Detector

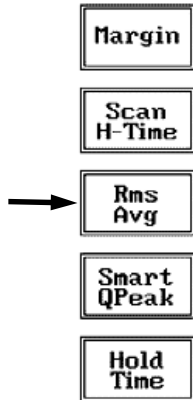

The **Smart Detector** is an innovative special function implemented in the PMM 9010 receiver with the purpose of reducing the test time and increasing the productivity of the lab.

This function works only when at least one limit is loaded, therefore remember to enable a limit to run the Smart detector function.

Selecting one out of the five **Smart detectors** the receiver will execute the scan using at first the Peak detector and, if a peak value is found over the selected limit minus a **Margin** set with the specific button, the reading is re-measured and displayed with the chosen (C-Avg, AVG, C-Rms, RMS or QPeak) detector.

Obviously this way of operation results in a much faster scan sweep and moreover it immediately draws the attention of the test Engineer to the most critical points. The limit associated to the Margin is displayed as a bold black line and is automatically selected by the receiver depending which Smart detector is chosen; for example, if a Smart QP is selected, the associated QP limit line will be displayed as a bold black line.

It is immediately clear that this function is very useful to dramatically reduce test time and increase the productivity of the test lab.

To deselect the Smart Detector function simply select a single detector.

The weighting time must be properly set in the Hold Time window to allow the Smart detectors functions to operate as intended.

The Hold Time is the measurement time the receiver takes to value the input signal and form result weighted by the selected detector.

When using the **C-Avg** (CISPR-Average) or the **C-RMS** (CISPR-RMS) detector, since for definition they are characterized by a long time constant, the minimum measurement time should be set long enough to allow a correct measurement.

For this reason, **when unknown signal are to be measured, the Hold Time should be at least 1000ms** to correctly weight signals pulsed at a rate of 5 Hz or faster.



With the Peak, RMS and AVG detectors the smallest settable measurement time depends on the RBW.

If several detectors are used contemporarily the Hold Time should be set to meet the requirement of the slowest one, so that the results of the measurement are correct for all them.

When a frequency change or an attenuation variation occurs, PMM 9010 waits automatically the time needed to the internal circuits to overcome the transient before the measurement time starts again.



PMM 9010 can be remotely controlled also when it is connected to its options such as 9030/9060/9180 and Click meter Switching operation Box.

**A-A.6 Operating
Manual
Changes**



Instruments manufactured after the printing of the User's manual may have a serial number prefix not listed on the title page; this indicates that instruments with different Serial Number prefix may be different from those documented in the manual itself.

Annex - B

Additional RBW filters



A-B.1 Introduction

All the following examples are indifferently referred to the PMM 9010 or the PMM 9010/03P/30P/60P.

PMM 9010 has been designed to allow the use of many RBW filters.

MIL-STD-461E requires the application of proper RBW Filters.

To have these additional RBW Filters available it is necessary to enable the related Option (see “MIL-STD-461E Activation procedure” paragraph).

It is recommended the upgrade of the Unit to a Firmware revision 1.85 or following. Please refer to chapter 8 of the User’s Manual to find the instructions concerning how to upgrade the internal firmware.

The present Annex provides information needed to use the added firmware functions both for PMM 9010 and for PMM 9030/9060/9180 extension.

A-B.2 MIL-STD-461E Activation Procedure (option)

To enable the MIL-STD-461E Filters use the 9010 Set code Utility.



For further information on software installation refer to the “Updating firmware and Activation code Utility” chapter.

Click on “9010 Set code Utility” (WRDONGLE.EXE) once for running the Set code program, so getting the following window:

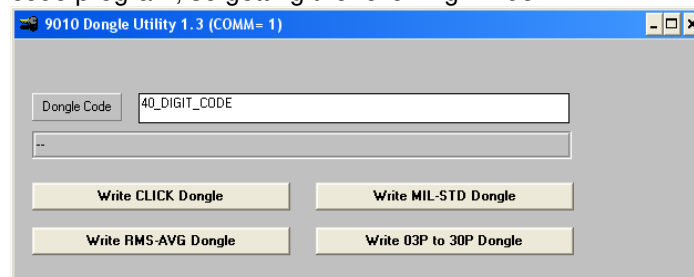

Copy the 40 Digit Serial Code in the Dongle Code Window and select the **Write MIL-STD Dongle** button.

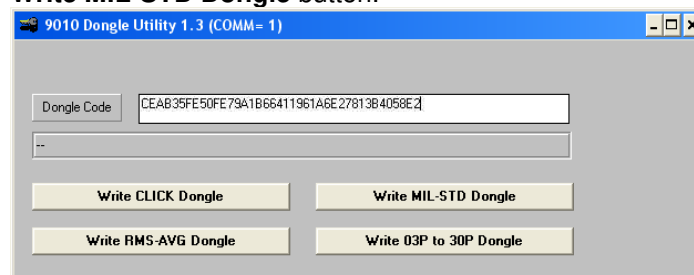

This message appears when the Dongle code is not valid



It will be shown the following message; press **OK** to confirm.

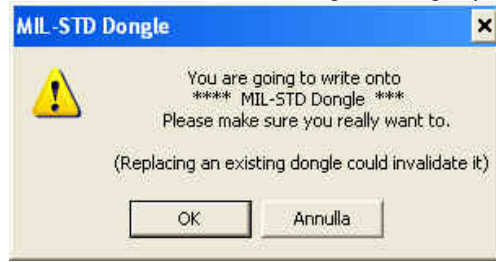

The software will inform that the Dongle Code has been successfully stored; Press **Ok** to close the program.



A-B.3 Analyzer Mode



To enter in the **ANALYZER Mode** it's enough to depress the Analyzer soft key on the main screen.

In this mode the receiver works as a powerful Spectrum Analyzer and the display shows the "spectrum analysis" in the frequency domain of a signal tuned at a given frequency.

The analysis is done at the selected span frequency.

Using the marker facility the User can accomplish a very accurate measurement of the signals either in frequency as well as in level.

A-B.3.1 RBW Selection

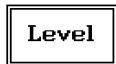
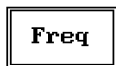

The Spectrum mode function is divided into five sub windows:

- Frequency
- Resolution Bandwidth
- Level
- Marker
- Wide Mode

The fifth button is used to change the spectrum view to **wide screen mode**, as shown in the picture 5-1, and with the **Esc** button the original view can be restored.

Always use Esc button to return to the previous view/condition.

A-B.3.2 MIL Filters

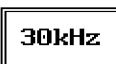

The **Resolution Bandwidth** command is used to select the bandwidth of the measuring filter.

The three larger filters are selectable from the first RBW screen, and pressing the **More RBW** button it is possible to select all the other filters.

These filters are mathematically modeled using FIR (Finite Impulse Response) technique and they are exactly as required by the standards.

Four additional bandwidth filters are now available:

- 10 Hz MIL at -6dB
- 100 Hz MIL at -6dB
- 1 kHz MIL at -6dB
- 10 kHz MIL at -6dB

A-B-2

Additional RBW filters



A-B.3.3 MIL Filters over 30MHz

Using PMM 9030, PMM 9060, PMM 9180, and PMM 9010/03P/30P/60P over 30 MHz, the 10 kHz, 100kHz and 1MHz filter are MIL-STD-461E (they are not optional but always available). The 1MHz filter is also CISPR 16-1-1 compliant (B-imp).

A-B.4 Manual Mode



The **MANUAL mode** is a very useful feature to manually control the receiver and to deeply investigate electrical signals modifying the parameters of receiver exactly as per the needs of the Test Engineer. It is possible, for example, to observe the signals exceeding the limits frequency by frequency; evaluating their levels measured simultaneously with 3 different detectors (Peak, RMS and Average); listening to them after a demodulation, etc.

To enter in **Manual Mode** press the key in the main menu.

A-B.4.1 RBW Selection



The Manual mode function has five sub windows:

- Frequency
- Level
- Resolution Bandwidth
- Hold Time
- Demodulation

Always use Esc button to return to the previous view/condition.

A-B.4.2 MIL Filters



The **Resolution Bandwidth** command is used to select the bandwidth of the measuring filter.

The three larger filters are selectable from the first RBW screen, and pressing the **More RBW** button it is possible to select all the other filters.

These filters are mathematically modeled using FIR (Finite Impulse Response) technique and they are exactly as required by the standards.

Four additional bandwidth filters are now available:

- 10 Hz MIL at -6dB
- 100 Hz MIL at -6dB
- 1 kHz MIL at -6dB
- 10 kHz MIL at -6dB

When a non-CISPR filter is selected, the Quasi Peak, C-RMS and C-AVG detectors are disabled.

A-B.4.3 Hold Time

Hold Time (ms) 0

The Hold Time (expressed in milliseconds) represents the time the receiver uses to “take a snapshot” of the incoming signal and to measure it with the chosen detector. When selecting a detector, the default hold time value is automatically loaded, but in some cases this time is not appropriate, e.g. when the interference signals have a low repetition rate or when the standard impose a proper measurement time.

In this case it could happen that the PMM 9010 sees a high input signal and therefore tries to set the proper attenuation automatically increasing the value or the input attenuators. However, when the input attenuation is set the signal is gone, so the receiver lowers the attenuation, but then a new peak arrives, and so on and so forth...

On the other hand, if the Hold Time is too high the PMM 9010 cannot properly follow the signals.

In this situation the Hold Time value should be manually set to find a correct compromise.

To set the Hold Time to the lowest possible value (this value dynamically depends from the measurement conditions), enter the figure 0; if a value lower than the allowed is entered, the lowest possible value is automatically selected.

The max. Hold Time that can be set is 30 sec (30.000 ms).



Be sure not to overload PMM 9010: the input signal should not exceed the maximum level indicated in the main specifications in chapter 1. Also do not apply any signal to RF generator output connector.



The weighting time must be properly set in the Hold Time window to allow the desired detectors to operate as intended.



PMM 9010 can be remotely controlled also when it is working with its options such as MIL Filters, 9030/9060/9180, Click meter and Four Channels Click Meter.

A-B.5 Operating Manual Changes



Instruments manufactured after the printing of the User’s manual may have a serial number prefix not listed on the title page; this indicates that instruments with different Serial Number prefix may be different from those documented in the manual itself.

Annex - C

Click4E Four Channels Click Meter Option



All the following examples are indifferently referred to the PMM 9010 or the PMM 9010/03P/30P/60P.



The Click 4E is no longer supported. Please, check the manufacturing status of the Narda products from the website at <http://www.narda-sts.it> or contact your Narda – PMM local Dealer

A-C.1 Introduction

The **CLICK mode** allows the User to make in a fast, easy and fully automatic way a difficult test like the Discontinuous Disturbances measurement, as defined by current CISPR standards.



To enable the Click Mode on the PMM 9010 or 9010/03P/30P/60P refer to the “Click Mode Operating Instructions” chapter.



9010 and 9010 Click4E Option system front view

A-C.2 Installation

This section provides the information needed to install your PMM 9010/Click4E.

It includes the information pertinent to initial inspection and power requirements, connections, operating environment, instrument mounting, cleaning, storage and shipment.

A-C.2.1 Initial Inspection

When receiving the equipment, first inspect the shipping card-box for any damages.

If the shipping box is damaged, it should be kept until the contents of the shipment have been checked for completeness and the instrument has been checked mechanically and electrically.

A-C.2.2 Packing and Unpacking

Verify the availability of all the shipped items with reference to the shipping check list enclosed with the Operating Manual.

Notify any damage to the forwarder personnel as well as to your NARDA Representative.

PMM 9010/Click4E includes the following items:

- PMM Four Channels Click Meter Option;
- Power Supply Cable
- DC Supply Cable to 9010
- BNC-BNC Cable
- Operating manual;
- Certificate of Compliance;
- Return for Repair Form.



WARNING

To avoid further damage, do not turn on the instrument when there are signs of shipping damage to any portion of it.

A-C.2.3 Preparation for Use



WARNING

This is a Safety Class I and Installation Category II apparatus, and it is equipped with a protective/functional earth terminal on the rear panel. A good safety/functional ground connection should be provided before to operate the receiver.

A-C.2.4 Click4E Option mains supply

PMM 9010/Click4E Option can work at either 50 Hz or 60 Hz with a supply voltage rated between 100 and 240 Volt AC.



It is necessary to use a cable, provided of the protective earth terminal and terminated with the right mains connector which fits the outlet in use.

**A-C.2.5 PMM 9010
Battery charging**

To supply the PMM 9010 it is either possible to use the standard battery charger supplied with the receiver, or connect the short cable from the **rear 12VDC connector** on the Click4E Option to the input CHARGER on the rear panel of the receiver as visible in the figure.

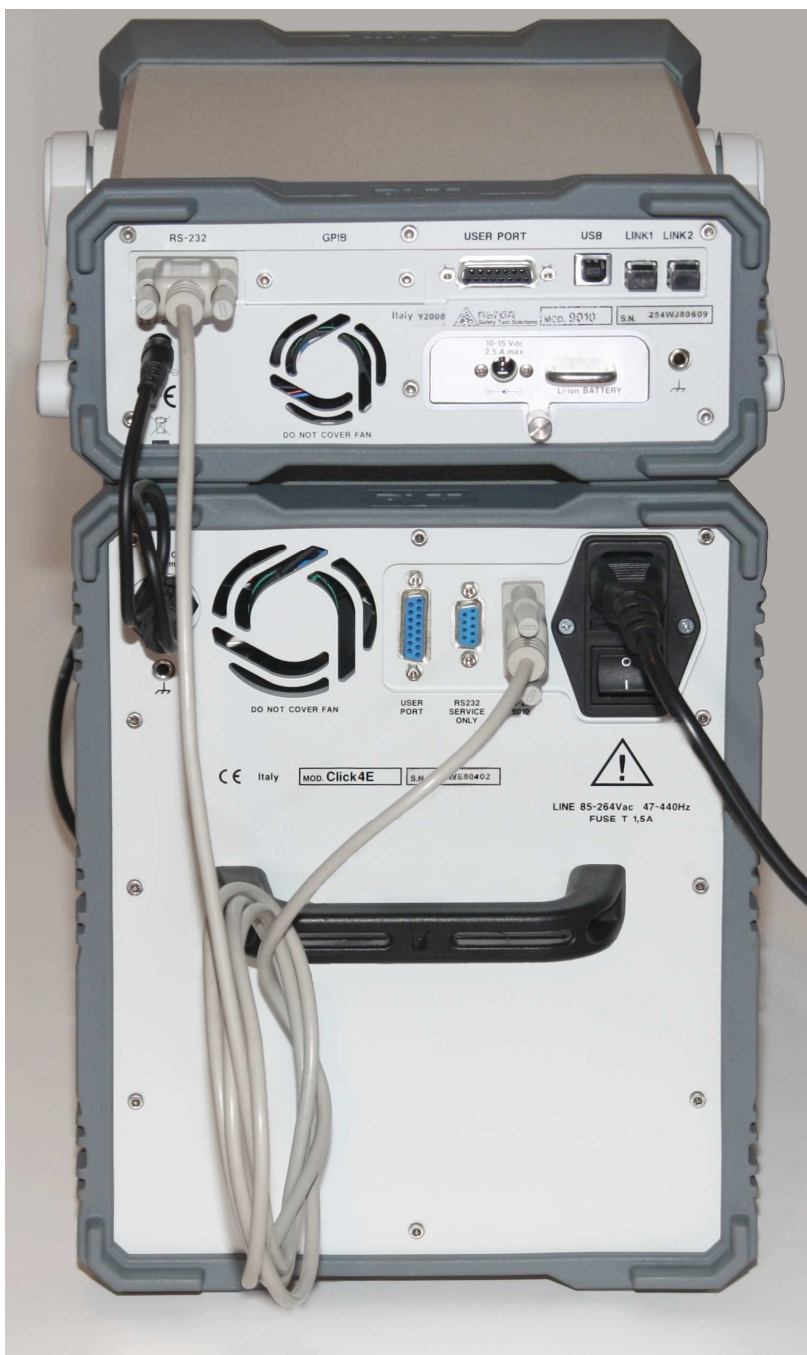

9010 and 9010 Click4E Option system rear view



Always connect all of the cables before of switching on the units.



A-C.2.8 Return for Service

If the instrument should be returned to NARDA for service, please complete the service questionnaire enclosed with the Operating Manual and attach it to the instrument. To minimize the repair time, be as specific as possible when describing the failure. If the failure only occurs under certain conditions, explain how to duplicate the failure.



If possible, reusing of the original packaging to ship the equipment is preferable. In case other package should be used, ensure to wrap the instrument in heavy paper or plastic.

Use a strong shipping box and use enough shock absorbing material all around the equipment to provide a firm cushion and prevent movement in the shipping box; in particular protect the front panel. Seal the shipping box securely.

Mark the shipping box FRAGILE to encourage careful handling.

A-C.2.9 Equipment Cleaning

Use a clean, dry, non abrasive cloth for external cleaning of the equipment.



To clean the equipment do not use any solvent, thinner, turpentine, acid, acetone or similar matter to avoid damage to external plastic or display surfaces.

A-C.2.10 Equipment ventilation



To allow correct equipment ventilation ensure that the vent grids on the rear panel and on the bottom of the receiver are free by any obstructing object.

A-C.2.11 Hardware Installation

PMM 9010/Click4E Option is delivered from factory ready to use. Remove the receiver from its cardboard shipping box, connect the power cord to the mains and **turn the rear power switch "ON"**.

The PW Led lights up.

After having been switched ON, the PMM 9010/Click4E Option boots with its internal BIOS and runs the firmware which manages the receiver.

At the beginning the instrument performs a diagnostic test to check if everything is working properly.

The boot sequence is indicated by a fast blinking of the four front panel leds.



The intercommunication between the two units is done by connecting the RS-232 Port of the 9010 to the RS-232 Port (to 9010) of the Click4E Option with a standard serial cable (supplied with the receiver).

When the Optional Unit is ready (the PW led is blinking and L1, L2, L3 leds are off) it is necessary to switch on the PMM 9010 receiver.

When the sequence is completed the PW Led on the Click4E Option becomes green and the main screen shows the test results and the main functional keys on the right of the LCD display: the receiver is now ready to operate.



Connect the supplied RF Cable from the Output BNC of the Optional Unit to the Input of the 9010 Receiver.

Connect the output of any LISN (or any other transducer) to the RF input of the Optional Unit.

When using a PMM LISN, it is possible to control from the receiver the lines of the LISN and automatically switch between them connecting a special cable between the User Port of the receiver and the LISN remote control input.

To switch OFF the unit move the main switch to "OFF" position.

A-C.3 Click Mode

Click

PMM 9010/Click4E Option gives the possibility to measure simultaneously up to four frequencies (channels) by the way reducing the time needed to complete the test.

To enter in **Click Mode** press the key in the main menu, and immediately the first window opens as follow:

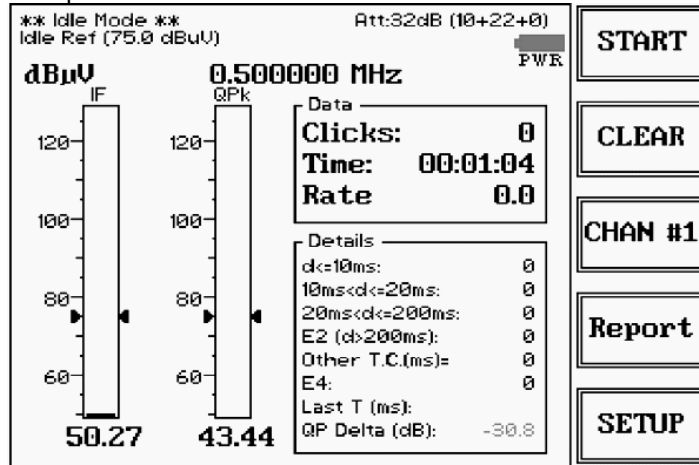

PMM 9010 initial screen showing the IDLE Mode of the Click Meter function. When the Click4E Four Channels Option is operating one more softkey is available to select which of the channels has to be investigated (CHAN #1 in the example above)

Att:32dB (10+22+0)

The digits are showed between brackets on the top of the screen stand for:

- 1st Digit is value automatically set by 9010 according to the Standard and to the Limit selected, as sensitivity of receiver has to be in a specific range around the level of selected Limit; just for precautions it is possible to add an external attenuation.
- 2nd Digit is a fixed attenuation value introduced by Click/4E extension unit (not changeable);
- 3rd Digit is corresponding to the eventual Extern.Att. value specified by operator in the Click Setup Menu when an external attenuator is being connected to the Click/4E RF Input for precaution.

In conclusion, the last Digit is the only one you can modify and set to the value of an externally applied attenuator.

A-C.3.1 Using an Artificial Mains Network (AMN or LISN)



When the PMM 9010 receiver is connected to a LISN to perform conducted interference measurements of the EUT, the RF output of the LISN shall be connected to the RF input of the receiver. In order to switch automatically between the lines of the LISN, it shall be connected to the User Port of the receiver thanks to the dedicated cable supplied with the LISN.

In order to avoid the unwanted tripping of the protection devices, an insulation transformer shall always be used between the mains supply and a LISN.

A-C.3.2 Using the Pulse Limiter

The built in pulse limiter is a useful device to protect the input of the receiver from transient over voltages. Sometime the conducted disturbances entering the receiver through the LISN are too high - even if they cannot be seen on the PMM 9010 because they are out of measurement bandwidth - and the associate energy is high enough to damage the input circuit.

The pulse limiter is automatically selected when needed and works as a protection of the input from unexpected pulses.



When using an external Artificial Mains Network, to reduce the probability of damages caused by transient voltage pulses always disconnect the PMM 9010 RF input before switching Equipment Under Test supply ON or OFF.



A-C.3.3 Click Mode menu

START

CLEAR

CHAN #1

Report

SETUP

The Click mode function has four commands:

- Start
- Clear: cancel and reset all data to start an idle test;
- Chan #n selects the channel to be displayed;
- Report
- SETUP

Always use Esc button to return to the previous view/condition.

When CHAN #1 is selected the working receiver is the external PMM 9010, when CHAN #2 is selected the L1 Led is green, the same for CHAN #3 and L2, CHAN #4 and L3.

During a standard measurement the corresponding Led will be on for each of the working channels.

Leds: **None = Chan #1** **L1 = Chan #2** **L2 = Chan #3** **L3 = Chan #4**

A-C.4 Self Calibration

Display

Autocal

Unit

RF OUT

PANEL

Pressing the **Autocal** button PMM 9010 and 9010/Click4E start performing their automatic self-calibration, using the internal precise tracking generator as a reference.

The connection between the internal tracking generator and the input of the receiver is done automatically inside the instrument.

The automatic Self Calibration, when the Four Channels Click meter Option is operating, is performed in two successive steps. During the first step Chan #1 and #2 carry out their autocal, and automatically at the end of this the Chan #3 and #4 carry out their own autocal.

During the autocal each channel led blinks green.

To interrupt the self-calibration press the key **Abort**.

When the self-calibration is successfully finished a message is displayed:

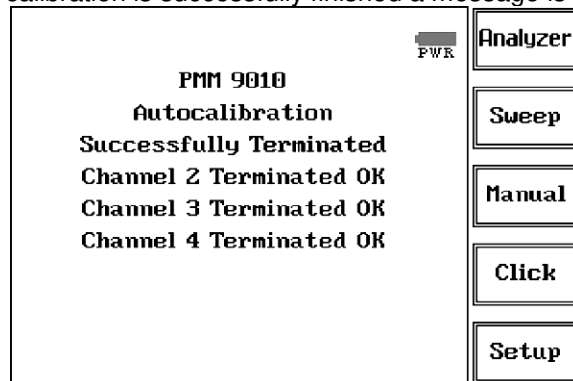

In order to avoid any possible external influence, it is suggested to disconnect all cables from the PMM 9010 and 9010/Click4E Option RF ports during the self-calibration process.

A-C.5 Operation

As soon as the Setup has been done it is possible to start the test. First of all the PMM 9010 will determine the click rate N , and – if all the conditions apply – after that the analyzer will immediately continue measuring the number of clicks exceeding the upper quartile limit L_q . Simply select **Start**: the PMM 9010 will automatically take care of all the necessary steps, reporting at the end of the test all the relevant results. In this way the PMM 9010 does the determination of the click rate at the two frequencies of 150 kHz and 500 kHz simultaneously, and then it executes the test.

A-C.5.1 Smart Measure

The “Smart Measure” is a PMM 9010 unique feature which allows a relevant time saving in Click measuring approach. PMM 9010 can trace and memorize eventual saturation just got during automatic measurement test procedure, in a way that, in case no saturation conditions at all have been detected, the so got test result can be used directly to soon calculate the new limit L_q , without the need of repeating the test for it.



To get the system working properly it is necessary the PMM 9010 runs a firmware revision 1.85 or following.



Be sure not to overload PMM 9010/Click4E: the input signal should not exceed the maximum level indicated in the main specifications. Also do not apply any signal to RF generator output connector.



Click Meter Reports can be remotely downloaded to the PC using the PMM Emission Suite Software.

A-C.6 Operating Manual Changes



Instruments manufactured after the printing of the User’s manual may have a serial number prefix not listed on the title page; this indicates that instruments with different Serial Number prefix may be different from those documented in the manual itself.

Annex - D

Procedure to measure the insertion loss of a LISN with a PMM 9010 Receiver



All the tests are done under the responsibility of the Operator who is carrying them out.

A-D.1 Introduction

This paragraph provides information concerning how to test and measure the **Insertion Loss** of any Line Impedance Stabilization Network (LISN). Taking this as a guide, in a similar way other instruments or circuits can be checked or calibrated.

A-D.2 Operation

The purpose of this procedure is to show how to operate the PMM 9010 receiver in order to measure the transfer function of a LISN in the CISPR 16-1-2 conducted frequency range from 9 kHz to 30 MHz. It can be useful, for example, to make periodic tests as well as to check new instruments or make comparisons.

A-D.3 Test setup

To carry out the test the following parts are required:

- EMI Receiver PMM 9010 with its User's Manual
- #2 RF Coaxial BNC-BNC Cables
- LISN under test
- Special AC-Plug to BNC adapters (provided for the most diffused AC single-phase Schuko and Three-Phase sockets, see following **A-D-13** section for further references)



A-D.4 Settings

Before starting the test, it is necessary to set the PMM 9010 receiver according to the following list.

Refer to the User's Manual to find how to operate the receiver in order to set it properly.

- RF OUTPUT = ON
- TG = ON (default)
- OUTPUT LEVEL = 90.0 dB μ V (default)
- MODE = SWEEP
- PRESELECTOR = ON (default)
- PREAMPLIFIER = OFF (default)
- REF. LEVEL= 110 dB μ V
- DYNAMIC RANGE = 80 dB
- ATTENUATOR = AUTO (default)
- DETECTOR = AVG
- HOLD TIME = MINIMUM (default)
- FREQUENCY = A+B (default)

A-D.5 Measure the Insertion Loss (Voltage Division Factor)



Be careful no voltage or mains network is connected to the device (LISNs or others) under test.

It is possible to check the test setup by connecting the RF Output of the PMM 9010 to its RF Input via one of the two BNC RF Coaxial cables (eventually, in two steps, one of the cables at first and then the other). In case the response is not as flat as expected please check the cables and eventually run the Autocalibration of the receiver, then repeat the test.



Fig. A-D-1 Receiver verification

A-D.6 Connecting the LISN under test

Before starting the measurement the LISN must be connected to the PMM 9010 EMI Receiver.

- ✓ Connect one end of the first coaxial cable to the RF Output of the PMM 9010 and the other end to the proper **Mains Supply-BNC Adapter**.
- ✓ Connect the second coaxial cable between the Receiver port connector on the LISN and the RF Input connector of the PMM 9010.
- ✓ Select the proper mains line under test (when possible).



A-D.7 Starting the Sweep

- Sweep
- Measure
- Limit
- Display
- Marker
- Load Store
- Exec Sweep
- Freq
- Level
- Conv Factor
- Re Do Sweep

The **Sweep mode** is used to operate the PMM 9010 as a powerful scanning EMI receiver. To enter in this mode it's enough to depress the **Sweep** soft key on the main screen, and immediately the scan setup window pops up and allows the operator to set the parameters for the scan. All the automatic settings (RBW, frequency step, etc.) refer to the CISPR standard.

Press the **Measure** softkey to enter the section where setting all the necessary parameters.

Set the desired line of the LISN (when available).

Always use **Esc** button to return to the previous view/condition.

After having chosen the frequency band and set all the other parameters it is possible to run the measurement scan simply touching the **Exec Sweep** button.

To make subsequent sweeps with the same setting parameters, simply press **ReDo Sweep**. This key is particularly useful after having loaded a previously stored track (see 4.6), as with the Re Do Sweep the original settings are kept for the new measurement: it is extremely easy to make comparisons, for example, before and after a modification of the test setup.

Once the scan starts, it can be stopped at any time during the execution by the **Stop** function key that appears during the scan.

The whole scan takes about 3 minutes for A+B frequency bands.

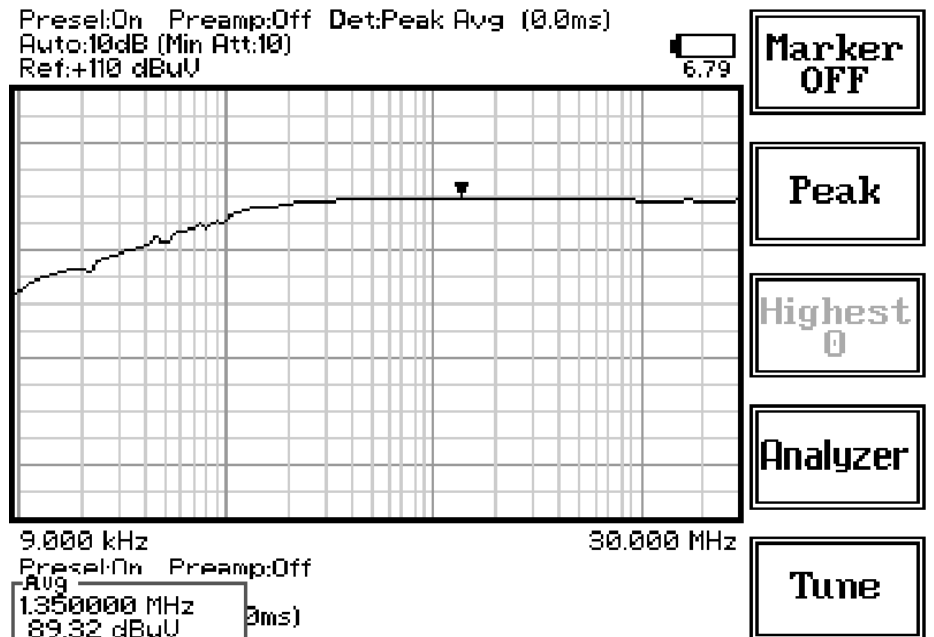

Fig. A-D-2 Sweep

A-D.8 Marker

Selecting this function a **Marker** is immediately enabled, and it appears on the screen as a small black pointing down arrow corresponding to the highest reading; simultaneously a small window shows up in the bottom left corner of the screen, indicating the actual frequency and level read by the marker. The **Marker Off** exits from the marker function.

A-D.9 LISNs with PMM Emission Suite

It is also possible, in a similar way, to run the performance test in the PC, using the **PMM Emission Suite**. Entering the **sweep** mode and clicking EXECUTE the PC software scans the selected frequency band.

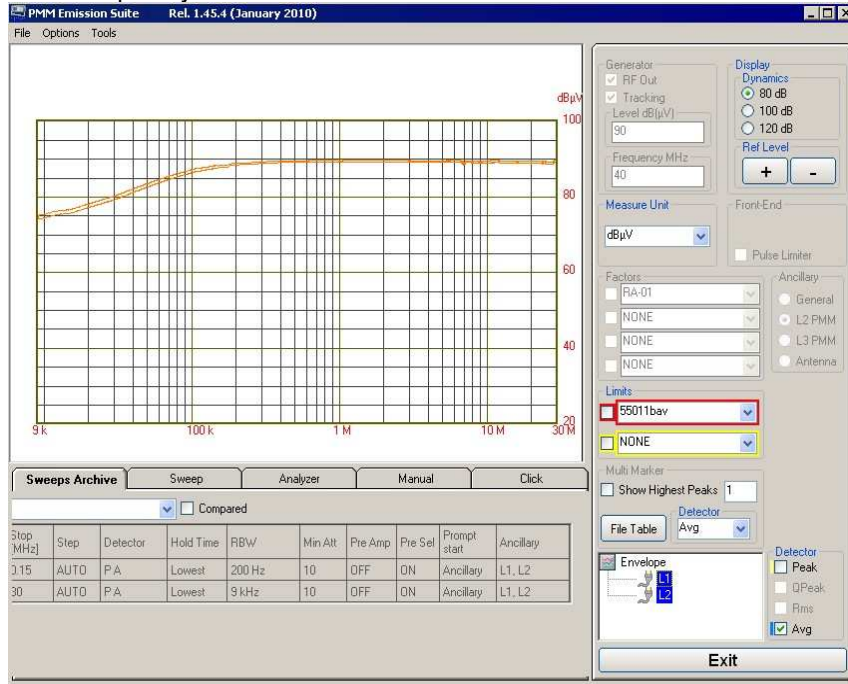

If a PMM LISN is to be checked it is also possible to automatically select the lines and show on the same graph all the responses (not forgetting to manually change BNC cable connection at LISN device's Line before starting the next sweep).

To do this please refer to the PEMS user's manual and select proper Ancillary.

Frequency band

Some LISNs have a frequency band filter which can be introduced when required.

PMM L2-16B for example is equipped with a switchable 150 kHz High Pass filter.

The frequency response of such a kind of filter is also verifiable applying the present procedure.

In this case the effects of the typical insertion loss of the circuit is summed to the attenuation of the filter itself.

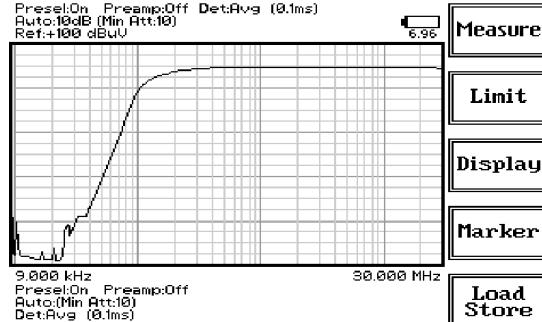

Example of the insertion loss of a PMM L2-16B LISN with the 150 kHz High Pass filter activated.

A-D.10 Note

This is not the procedure suggested by the Standard and used to certify the LISNs.

If the measurement results are different from what expected please check again and eventually refer to Customer's Care service.

CISPR standard recommended calibration setup is reported below and requires an expensive Network Analyzer equipment.

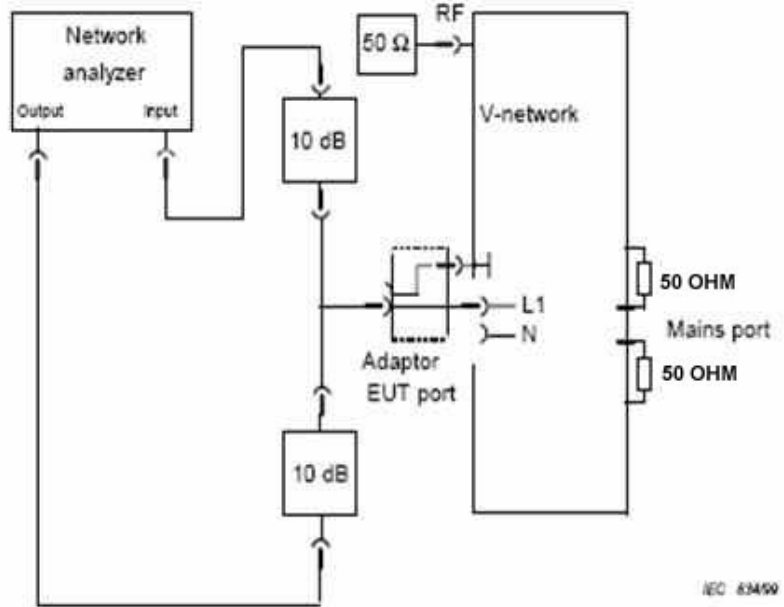

Figure A.6a – Test set-up for normalization of the network analyzer

Fig. A-D-3 Network analyzer calibration Setup (L1)

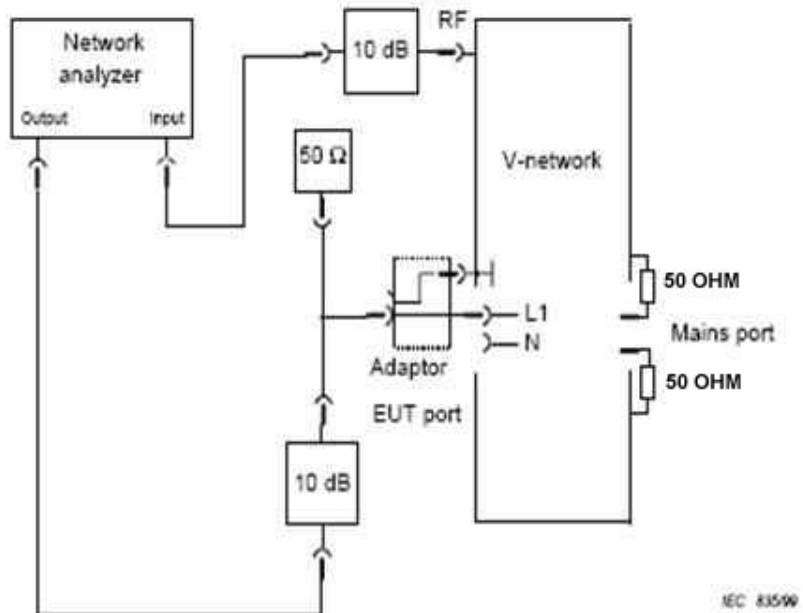

Figure A.6b – Test set-up for measurement of the voltage division factor

Fig. A-D-4 Measurement Setup (L1)

A-D.11 PMM LISNs and Passive probes



Fig. A-D-5
L1-150M: Single line LISN, 150A LISN



Fig. A-D-6
L2-16B: Two lines, Single phase, 16A LISN



Fig. A-D-7
L3-32: Four lines, 3-phase, 32A LISN



Fig. A-D-8
L3-64: Four lines, 3-phase, 64A LISN



Fig. A-D-9
L3-64/690: Four lines, 3-phase, 64A – 690Vac LISN



Fig. A-D-10
L3-100: Four lines, 3-phase, 100A LISN



Fig. A-D-11
L1-500: Single line LISN, 500A LISN



Fig. A-D-12
L3-500: Four lines, 3-phase, 500A LISN



Fig. A-D-13
SHC-1/1000: 35 dB CISPR Voltage probe



Fig. A-D-14
SHC-2/1000: 30 dB CISPR Voltage probe;

A-D.12 Conversion table
dB μ V \leftrightarrow μ V \leftrightarrow dBm

dB μ V	μ Volt	dBm (Z=50 Ω)	pWatt (Z=50 Ω)
-20	0.1	-127	0.0000002
-10	0.3	-117	0.000002
0	1	-107	0.00002
6	2	-101	0.00008
10	3	-97	0.00020
12	4	-95	0.00032
20	10	-87	0.002
24	16	-83	0.005
30	32	-77	0.020
32	40	-75	0.03
40	100	-67	0.20
45	178	-62	0.6
50	316	-57	2.0
55	562	-52	6.3
60	1000	-47	20
65	1778	-42	63
70	3162	-37	200
75	5623	-32	631
80	10000	-27	1995
85	17783	-22	6310
90	31623	-17	19953
95	56234	-12	63096
100	100000	-7	199526
107	223872	0	1000000

A-D-15 Conversion table

A-D.13 LISN Service kit The LISN Service kit includes special AC-Plug to BNC adapters.



A-D-16 PMM L2-16 model adapter (Single-phase 16 A sockets)



A-D-17 PMM L3-32 model adapter (32 A sockets)



A-D-18 PMM L3-64 model adapter (64 A sockets)

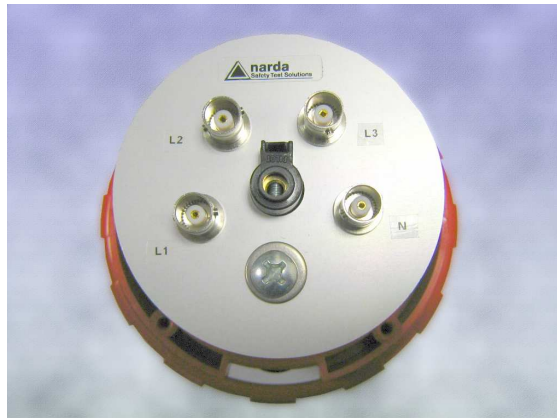

A-D-19 3-phase socket to BNC adapter. Model adequate to **PMM L3-100** and higher (100 A sockets)



A-D-20 Rigid case



A-D-21 Rigid case internal view



L3HARRIS



NARDA Safety Test Solutions S.r.l. Socio Unico

Sales & Support: Via Rimini, 22 20142 - Milano (MI) Tel.: +39 02 581881 Fax: +39 02 58188273

Manufacturing Plant: Via Benessea, 29/B 17035 Cisano sul Neva (SV) Tel.: +39 0182 58641 Fax: +39 0182 586400



http://www.narda-sts.it

Mod. 18-1

Caro cliente

grazie per aver acquistato un prodotto NARDA! Sei in possesso di uno strumento che per molti anni ti garantirà un'alta qualità di servizio. NARDA riconosce l'importanza del Cliente come ragione di esistenza; ciascun commento e suggerimento, sottoposto all'attenzione della nostra organizzazione, è tenuto in grande considerazione. La nostra qualità è alla ricerca del miglioramento continuo. Se uno dei Suoi strumenti NARDA necessita di riparazione o calibrazione, può aiutarci a servirla più efficacemente compilando questa scheda e accludendola all'apparecchio.

Tuttavia, anche questo prodotto diventerà obsoleto. In questo caso, ti ricordiamo che lo smaltimento dell'apparecchiatura deve essere fatto in conformità con i regolamenti locali. Questo prodotto è conforme alle direttive WEEE dell'Unione Europea (2002/96/EC) ed appartiene alla categoria 9 (strumenti di controllo). Lo smaltimento, in un ambiente adeguato, può avvenire anche attraverso la restituzione del prodotto alla NARDA senza sostenere alcuna spesa. Può ottenere ulteriori informazioni contattando i venditori NARDA o visitando il nostro sito Web www.narda-sts.it.

Dear Customer

thank you for purchasing a NARDA product! You now own a high-quality instrument that will give you many years of reliable service. NARDA recognizes the importance of the Customer as reason of existence; in this view, any comment and suggestion you would like to submit to the attention of our service organization is kept in great consideration. Moreover, we are continuously improving our quality, but we know this is a never ending process. We would be glad if our present efforts are pleasing you. Should one of your pieces of NARDA equipment need servicing you can help us serve you more effectively filling out this card and enclosing it with the product.

Nevertheless, even this product will become obsolete. When that time comes, please remember that electronic equipment must be disposed of in accordance with local regulations. This product conforms to the WEEE Directive of the European Union (2002/96/EC) and belongs to Category 9 (Monitoring and Control Instruments). You can return the instrument to us free of charge for proper environment friendly disposal. You can obtain further information from your local NARDA Sales Partner or by visiting our website at www.narda-sts.it.

Servizio richiesto: Service needed:

Solo taratura Riparazione Riparazione & Taratura Taratura SIT Altro:
 Calibration only Repair Repair & Calibration Certified Calibration Other:

Ditta:

Company:

Indirizzo:

Address:

Persona da contattare:

Technical contact person:

Telefono:

Phone n.

Modello:

Equipment model:

Numero di serie:

Serial n.

Accessori ritornati con l'apparecchiatura: Nessuno Cavo(i) Cavo di alimentazione Altro:
 Accessories returned with unit: None Cable(s) Power cable Other:

Sintomi o problemi osservati: Observed symptoms / problems:

Guasto: Fisso Intermittente Sensibile a: Freddo Caldo Vibrazioni Altro
 Failure: Continuous Intermittent Sensitive to: Cold Heat Vibration Other

Descrizione del guasto/condizioni di funzionamento:

Failure symptoms/special control settings description:

Se l'unità è parte di un sistema descriverne la configurazione:

If unit is part of system please list other interconnected equipment and system set up:

