



# narda

## Safety Test Solutions<sup>®</sup>

an  Communications Company



**Fully CISPR-Compliant  
Digital EMC/EMI receivers  
10 Hz – 18 GHz**

**9010 - 9030 - 9060 - 9180**

9010  
9030  
9060  
9180



## Main features at a glance

- The state-of-the-art full compliance 30 MHz EMI Digital Receiver is the platform of the system. Based on direct Analog to Digital conversion and sophisticated computation, it offers calibration-free operation on almost all of its key components, i.e. RBW filters, detectors, demodulation... while the RF front-end is self-calibrated by the internal, precise RF signal generator.
- All the units are uniquely compact and lightweight: the low frequency unit (9010) is about 4,1 kg and the high frequency extensions are about 2 kg. All are battery operated.
- Hardware and Firmware are designed around the current EMC standards, and ready to upgrade to future changes in the same.
- Powerful digital Click Analyzer is fully compliant with the latest CISPR specifications, 1 (internal option) or 4 (external option) channels.

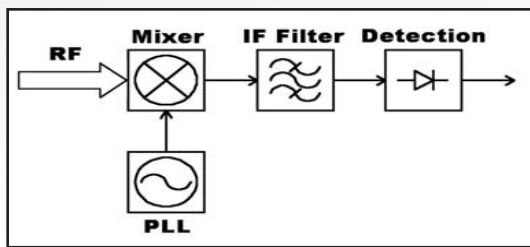

## Performance characteristics highlights

- Frequency ranges from 10 Hz to 30 MHz; 3 GHz; 6 GHz; 18 GHz
- Full compliance with the latest edition of CISPR 16-1-1 standard, including RMS-AVG detector, APD function, click measurements, etc.
- Commercial and military standards met within the frequency range
- CISPR and MIL-STD RBW filters.
- Integrated preamplifier (all units) and pulse limiter (only 9010).
- Mostly maintenance and calibration free; service done in minutes.
- Excellent RF characteristics.
- Built-in tracking signal generator up to 30 MHz (9010).
- Multimode functions: sweep, spectrum analyzer, scalar network analyzer, manual receiver.
- Smart Detector: a "productivity booster" feature specifically designed to dramatically improve test speed.

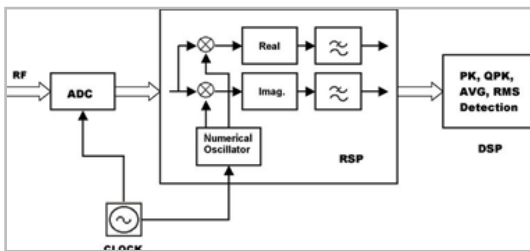



## Precise, accurate, fast and easy-to-use full compliance EMI/EMC tests to civilian and military standards

The latest design effort of Narda STS has produced a fully digital EMC receiver up to 30 MHz. The advantages of the digital techniques extended up to several GHz, thus creating outstanding equipment perfectly fitting the need of any designer and test engineer.

The new EMI/EMC receivers 9010, 9030, 9060 and 9180 are fully compliant with CISPR16-1-1 requirements and meet all commercial and military standards for EMC measurements, including the latest revisions.

They exhibit an outstanding precision and are practically free of calibration; they are as small as possible, lightweight and battery operated; they are easy-to-use and easy-to-interface with a regular PC, and they are to a wide extent flexible and programmable, both locally and remotely. Servicing is as easy as to plugging a card into a computer and can be done simply by swapping with pre-calibrated RF modules.

These new concepts make the Narda STS receivers cost-effective and easy to update simply by downloading new firmware versions to cover all the future revisions of the relevant international standards.



- Flexible, easy to use for any kind of measurement in stand-alone, integrated in systems or driven by PC.
- Optical link between main and high frequency units.
- No need for a coaxial cable to connect the antenna to the receiver.
- No aging of critical receiver parts (RBW filters, detectors, mixers, local oscillators, etc.) that cause degradation of the measurement accuracy.
- Easily and quickly serviced by swapping factory calibrated modules.
- Cost-effective.

- Internal memory for limits and correction values: antenna factors, cable loss, probe factors etc.
- Built-in manual, semiautomatic and fully automatic test routines.
- All calculations required by the newest standards (e.g. Click, APD, RMS-AVG, etc.) automatic and built-in.
- Battery powered.
- Extremely fast in all measurements.



**9010: the new fully digital receiver  
that outperforms competition is here**

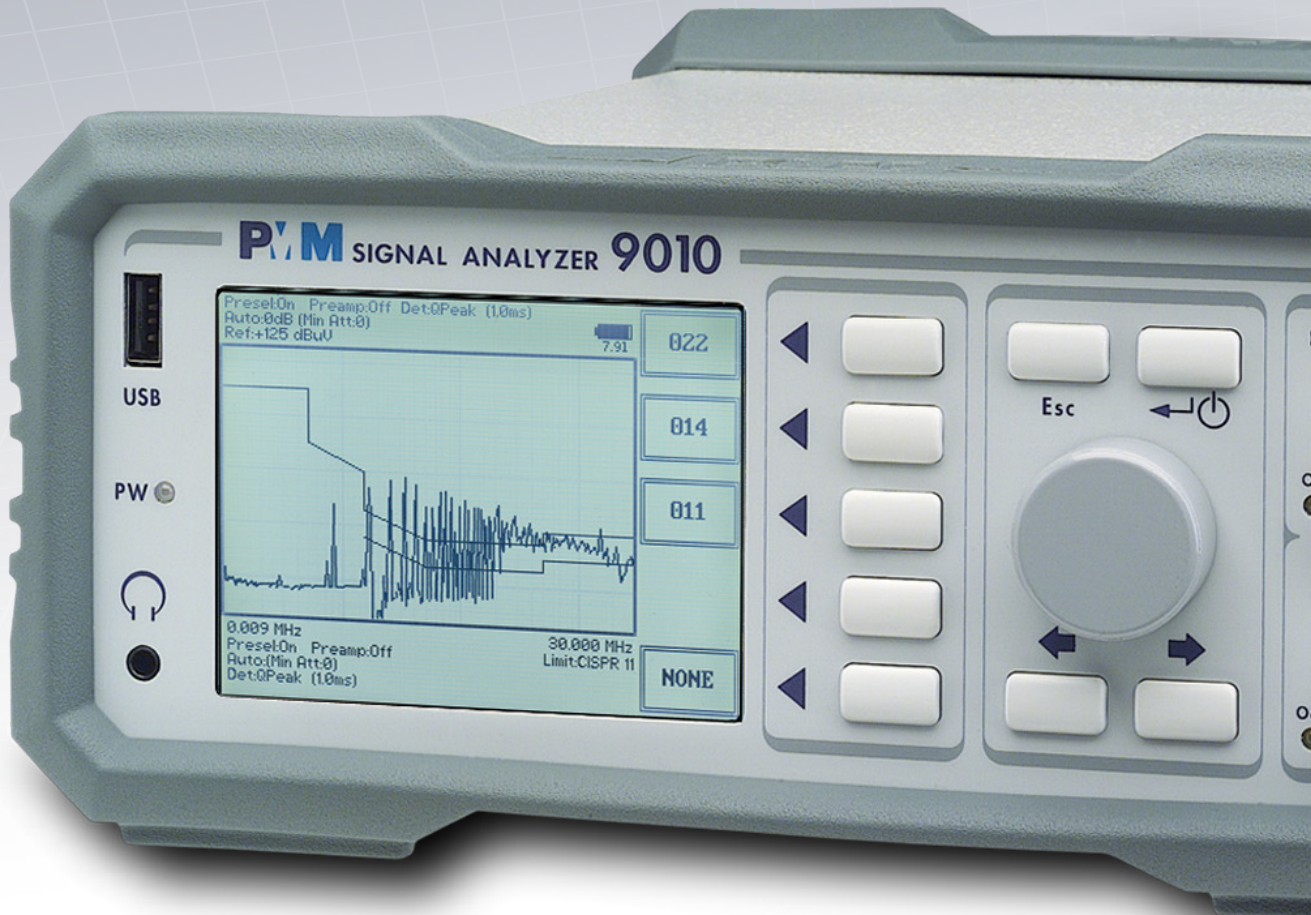

Once more Narda STS is anticipating the market and competition by introducing the first Fully Digital EMC Receiver and Analyzer that meets all the requirements of the latest civilian and military standards (CISPR-16-1-1 & MIL-STD-461F).

Every circuit in the receiver is digital now, with the only exception of the attenuator and the preselector that – physically – shall put a limit to the RF energy entering the equipment.

This architecture, carefully designed to deliver

outstanding performances in a very small volume, is the latest development of Narda STS R&D Labs, well known all around the world with the former name "PMM" for their original and effective technical solutions.

Add the usual "Easy-to-Use" Narda STS software - always acknowledged for offering the best equipment control with a simple and intuitive user interface - and the picture of the new 9010 is almost complete.

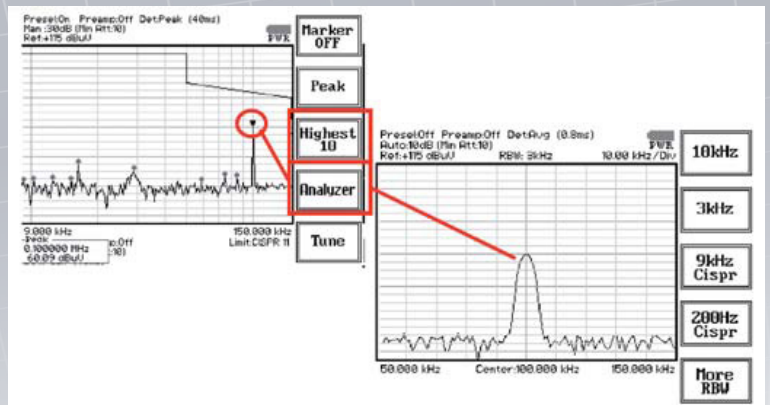
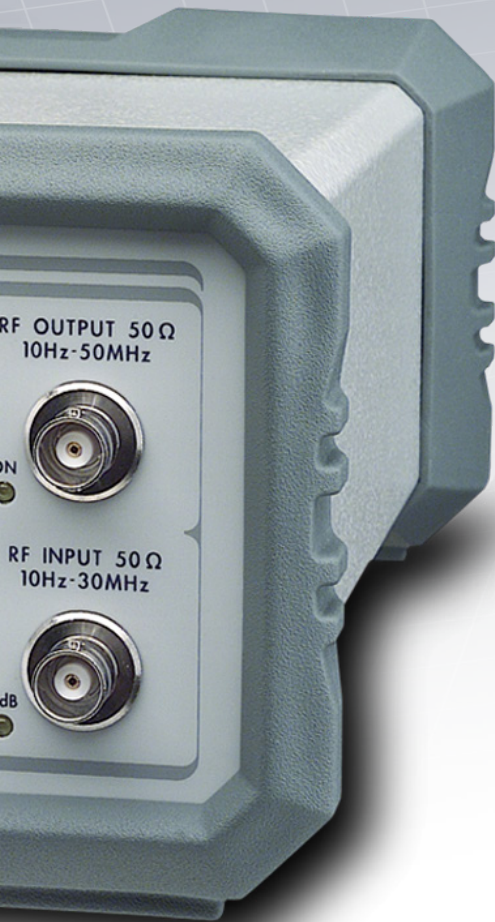

The 9010 features several useful functions: as an example, pictures above show the automatic highest peaks finder and the intuitive way to observe the selected peak in Analyzer mode: from measurement to debugging at users' fingertips!

Practically maintenance-free and exceptionally stable, the 9010 EMI Receiver is the ideal solution for reliable measurements day after day, month after month, year after year.

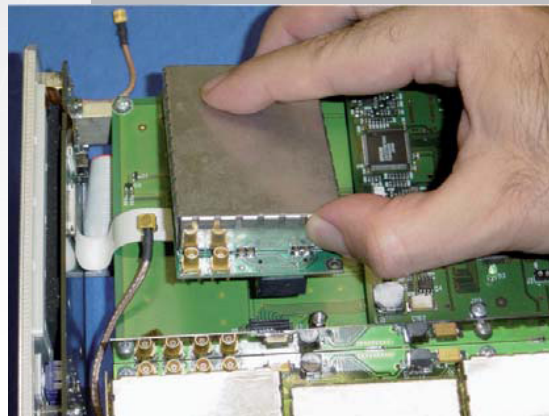

Moreover, the outstanding feature that service can be easily done by simply replacing plug-in pre-calibrated subassemblies, represents a highly valued advantage in case, for example, of damage to the RF front-end. Indeed, even when an excess of energy

or a too high signal would burn the input stage, the Customer can be back in operation and continue his work in the shortest possible time, being sure that his receiver is still perfectly calibrated.

The Narda STS Sales Network is highly qualified and will be your consultant for every measurement problem: ask the experts and make your job easier with 9010, the guiding star in the EMC market.

9010: the new fully digital receiver that outperforms competition is here. Continuing the tradition of offering innovative technical solutions for easy and practical measurements applications, the 9010 - a fully digital receiver in the 10 Hz to 30 MHz range - is the first cornerstone of a system which grows together with the users' needs: all EMC conducted measurements will be possible by simply upgrading the 9010 with specific options, e.g. Click Meter, MIL-STD filters, and

accessories - LISNs and probes - providing a full compliance with almost all international standard or proprietary specifications. Moreover, the modular construction, based on pre-calibrated subassemblies, offers the fastest and most convenient recalibration and service ever

**9030, 9060 and 9180  
9010 companion products  
for testing up to 3, 6, or 18 GHz**



Until now, technology has not allowed a fully digital receiver up to the GHz range, Narda STS has conceived the best possible solution designing these extensions for 9010, enabling the whole test system to go up to 3, 6 or 18 GHz taking all the benefits from the digital approach.

The 9030, 9060 and 9180 are therefore the ultra-fast 30 MHz - 3 GHz, 6 GHz or 18 GHz receivers extending the measurement frequency range of the 9010 up to the field of Radiated Emissions, thanks to a dedicated RF module. A fast and safe connection with 9010 is guaranteed by a High Speed Digital Optical Link, providing the most immune way to transfer data: only the real measurement data received at the antenna reaches the detectors! This dedicated digital Front End perfectly matches with the 9010, to create a compact-size, up-to-date digital receiver up to 3, 6 or 18 GHz.

9030, 9060 and 9180 are basically a highly sophisticated auxiliary equipment, which converts the RF input into a digital signal sent to 9010 through a Fiber Optic Cable. The transfer rate is higher than 2.5 GB/s and a huge amount of information is handled by the proprietary protocol.

Very limited dimensions and lightweight construction allow the 9030, 9060 and 9180 to be connected directly to the antenna, making the dream of many test engineers come true. Benefits are really many, as RF coaxial cables for antenna to receiver connection may significantly affect measurements due to intrinsic cable loss and impedance mismatch. Moreover, cables may pick up unwanted RF signals along the path from the antenna to the receiver. The 9030, 9060 and 9180 overcome

all those error sources through the optical link, thus providing more accurate and reliable measurements.

In order to allow complete galvanic separation, 9030, 9060 and 9180 are battery powered by the same Li-Ion plug-in rechargeable battery used for the 9010 unit, thus providing interchangeability and noise-free performances for up to four hours of continuous operation. Replacing the plug-in battery is just a matter of seconds.

The PMM software can drive the coupled 9010-9030, 9010-9060 or 9010-9180 to easily perform any measurement foreseen by the commercial and military standards, even stand-alone or, whenever required, with the necessary auxiliary equipment.

The APD (Amplitude Probability Distribution) function is another example of how well the new PMM receivers can respond to the evolving requests of upcoming standards.

The APD is a statistical characterization of signals recently introduced for testing above 1 GHz, that requires scanning of selected spans and measurements on several frequencies using Peak detector and Max Hold function, then sorting frequencies that show highest disturbance levels and comparing them with the limits for a given "Probability".



This requires the receiver featuring outstanding hardware with high range, huge memory and ultra fast computation capabilities - and a software capable of handling all the different test possibilities (two approaches are defined: E-based and P-based).

Moreover, to make the Test Engineer's life easier, the software allows the user to adopt the most convenient test approach - fully automatic, semiautomatic, manual, etc. - and, last but not least, to report all the data and results the User may need.



Universal kit for mounting 9030, 9060 & 9180 directly on the antenna connector

Fiber Optic link between 9010 main unit and 9030, 9060 & 9180 RF extension units. Max.Length: 100 m.

## High performance digital architecture

characterized by an ultra-fast A/D converter with the DSP controlling 3 processors for different functions: RSP (Receiver Signal Processor), FPGA and CPLD.

## No calibrations, no adjustments

after the A/D converter which is inserted in the circuit just when the signal comes out of the input attenuator and the preselector, to take the maximum benefit from the digital approach. All the internal references are derived from the system clock: the receiver is free from any phase noise, jitter, drift, etc.

## High-speed RSP and DSP

for highest precision and simultaneity. A dedicated Receiver Signal Processor handles all the numeric signals within the digital IF, while the Digital Signal Processor provides all of the calculations and signals treatment, like simultaneous detections, demodulations and graphical representation in real time.

## The powerful RSP (Receiver Signal Processor)

allows the use of the FIR (Finite Impulse Response) technique to create digital RBW filters: the result is an impressive lifetime stability of such filters and a shape controlled to the perfection, due to its mathematical modelling. The competitive receivers featuring analogue filters are definitely several steps behind.

The Numeric Local Oscillator generates pure mathematical signals for the Digital IF Filters, divided into Real and Imaginary parts. The main advantage of the mathematic approach is that the computing function do not generate those spurious components a conventional analog mixer would do.

## The Pure Mathematical Detectors and Functions

feature absolute stability and lifetime calibration-free operation. The response of such RF receiver is no longer depending from the input signals and the detectors always work exactly as intended. These detectors are mathematical functions for unsurpassed performance and precision: they are simply the best and simultaneous by definition. It shall be noted that all these detectors and functions are needed in a receiver full compliant to the latest CISPR 16-1-1. Then the Product Committee can decide which of these features are the most appropriate; for instance, the latest RMS+Avg detector and the APD functions – as well as the Average detector - will be used with the new digital equipment and/or above 1 GHz. No problem for other products still requiring the more traditional Quasi- Peak and Average detectors: they're all on board

## Absolute and stable compliance to CISPR/MIL-STD

of all digital RBW filters. It's simply amazing the perfection of these filters mathematically created and shaped to meet exactly the CISPR requirements.

If needed by changes in the standards, new markets opportunities, custom requests etc. Narda can model new filters to upgrade the receivers and implement the new features.

This consists just in firmware upgrade done by the user and is a matter of seconds.

## Ultra-fast measurements of CISPR A-band (9 kHz ÷ 150 kHz)

the FFT (Fast Fourier Transform) function allows to perform a full scan of the whole A-band in only 1 second! Even when the source is emitting for very short periods of time - or when the source operating cycle is extremely short, there is a much higher probability to capture and measure the disturbance.





## Hold Time

another step ahead from analogue behaviour! At each frequency step, given by the selected filter bandwidth, the 9010 really stops for the preset time, so taking a perfect picture of the signal under analysis, while analogue receivers may show a certain “drift” depending from the sweep time.

With setting equal to 0, the Hold Time is the minimum time of permanence required by the selected IF filter for the fastest possible measurement speed

## Built-in Preselector

designed to make correct measurements of all input signals, including pulses. The quality of the preselector - one of the very few analogue sections in the receiver - is essential to guarantee the best performances and represents the most important difference between a true EMI Receiver, capable of the more reliable results, and a generic Spectrum Analyzer adapted to perform EMC measurements.

## The Auto Attenuator

provides maximum dynamic range without distortion. It is controlled by an FPGA (Field Programmable Gate Array) directly driven by the internal DSP (Digital Signal Processor) and provides optimum performances in every testing condition, while protecting the RF input (e.g.: zero dB attenuation is not allowed in auto-attenuation mode).

## The Built-in Preamplifier

of 9010 cannot be saturated thus it provides correct response to continuous and pulsed signals, while in most receivers the preamplifier is directly connected to the RF input. Saturation might be there without notice!

## Pulse Limiter

is built-in in the 9010, providing an extra protection, if required.

## The Pre-Loaded CISPR Limits

are stored in a non-volatile memory and immediately available for tests done in “Sweep Mode”: easy, fast and error free!

## The Internal RF Generator

in 9010 is a very flexible RF generator tracking with the span or settable at any frequency in the range of 10 Hz ÷ 50 MHz: another powerful tool for the designers that makes the 9010 an easy-to-use scalar network analyzer for characterizing components, filters as well as for automatic insertion loss measurements (CISPR 15/ EN 55015). This generator provides also the selfcalibration of the equipment, as it represents the main frequency reference for all the receiver operation.

To keep it calibrated, it's enough to send back to Narda just the generator module itself: a terrific advantage in terms of costs and speed.

## The Click Meter Option

allows the user to perform continuous disturbance tests in a straightforward and easy way.

The receiver takes care of everything: evaluation of the Click Rate N; applicable exceptions; Click measurement using Upper Quartile Method; Full Report with all mandatory data.

9010 fully supports the new standard dealing with all the allowed four exceptions, showing in real time all the events including click details and reporting all mandatory and optional data to make a detailed report. It shall be noted that the handling of E-3 is the most demanding in terms of hardware and software, however it is also the exception that is more beneficial for the customer, as it allows to skip unnecessary tests. In general, the first investigation is terminated as per one of the required events listed in the standard: after 40 clicks; after the standard 120 minutes; after a specific time span; manually; paused and resumed to allow restarting recursive EUT programs.

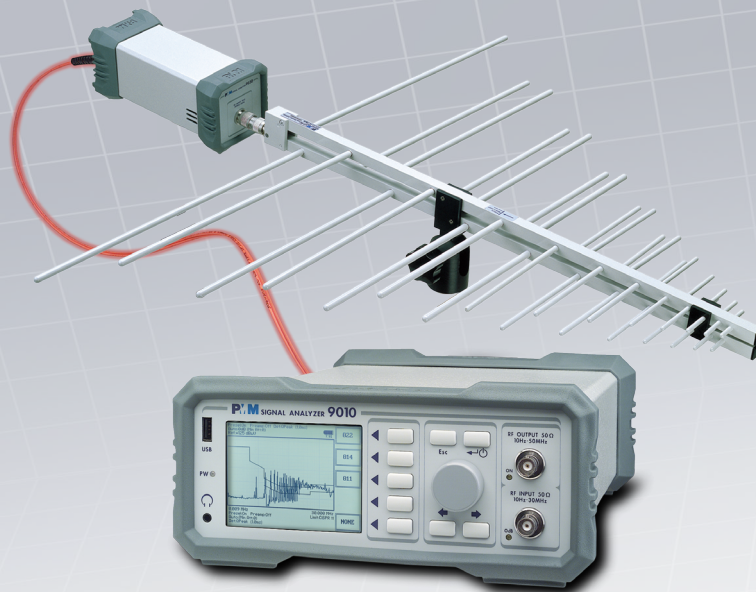

Moreover, the 9010 has the unique feature "Smart Measure" that can dramatically speed up the Click test: another productivity feature by Narda STS.

## Input and Output

USB 2.0, RS232C, and Bluetooth for PC communication (GPIB/IEEE-488 via optional external adapter).

Programmable User Port to control auxiliary equipment like LISNs and other automatic equipment.

High-Speed Optic links featuring 2.6 GBps transfer rate, Bluetooth link, battery charger

## Graphic Display

Instruments typically compromise physical dimensions with display size and type.

Despite its small size, the 9010 features a sophisticated graphic process that allows the bright, clear, 16-levels grey backlighted display to catch and show even the narrowest peak in the spectrum

## Controls

the receiver can be operated as stand-alone by the front knob and soft keys through user-friendly menus, or remotely by a PC connected via USB or RS232 Serial interface (Bluetooth optionally).

## Rechargeable/Replaceable Internal batteries

for enhanced portability and for field tests, also offering the major advantage of being completely disconnected from the mains in critical analysis, for measurements not influenced at all in hostile or noisy environments.

## Easier Radiated Power set-up

as the high frequency receiver can be mounted directly on top of the EM Clamp using a suitable Clamp Adapter and a very short cable connection from the receiver to the EM Clamp.

This means that the long, movable connection (usually going to a reel on the ceiling of the lab and from there to the receiver) is made with a fibre optic, not with a coaxial cable which is heavier, thicker, less flexible, more subject to damage - especially near to the connectors. Again, mechanical and electrical advantages for the test Engineers.

## In-situ Tests

or any tests where the connection to the supply network may introduce additional noise, e.g. due to ground loops - are no longer a problem with the 9010 / 9030 / 9060 / 9180 receivers: they are battery operated and all share the same model of rechargeable battery. Easy, clean, fast, simple

ANALOGUE TO DIGITAL UNCERTAINTY COMPARISON		
Input Quantity	Analogue uncertainty contribution (typical) in dB	9010 uncertainty contribution
Receiver reading	$\pm 0.1$	Equal or better
Aging	TBD, but not present	Absent
Attenuation: Antenna receiver Cables Connections	$\pm 0.1$ TBD, but not present TBD, but not present	Equal Absent Absent
Receiver correction: Sine wave Pulse amplitude response Pulse repetition rate response	$\pm 1.0$ $\pm 1.5$ $\pm 1.5$	Better Better Better
Mismatch: Antenna-receiver Antenna-cable Cable-cable	+0.9/-1.0 TBD, but not present TBD, but not present	Equal Absent Absent
Cable-Antenna (or other transducer, e.g. E.M. clamp) balance	$\pm 0.9$	Better (w/ 9030-9060-9180)
Cables coupling to ground	TBD, but not present	Absent with 9030, 9060 or 9180

### BACKGROUND LOG-PERIODIC ANTENNA VERTICAL POLARIZATION

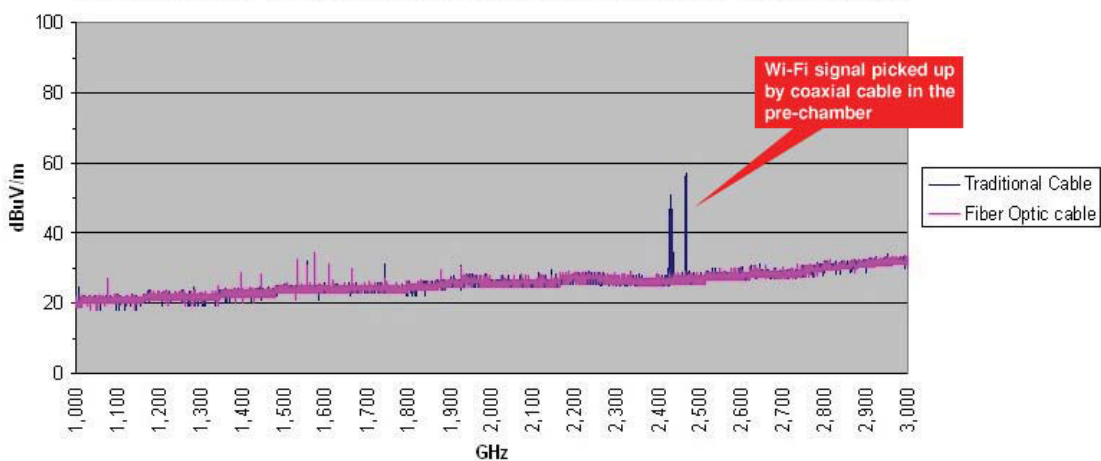

Comparison between antenna-receiver connected by coaxial cable (blue trace) and 9030 directly connected to the antenna and linked to 9010 by fiber optic cable (pink trace). The example shows how PMM's solution can prevent unwanted signals being picked up by the coaxial cable along its path from the antenna to outside the chamber.



The same rechargeable plug-in battery is used for all 9010, 9030, 9060 & 9180

## Operating Principles of the 9010 - 9030 - 9060 - 9180

Perfect, life-long stable and calibration-free RBW filters  
(picture: 200 Hz RBW CISPR filter)

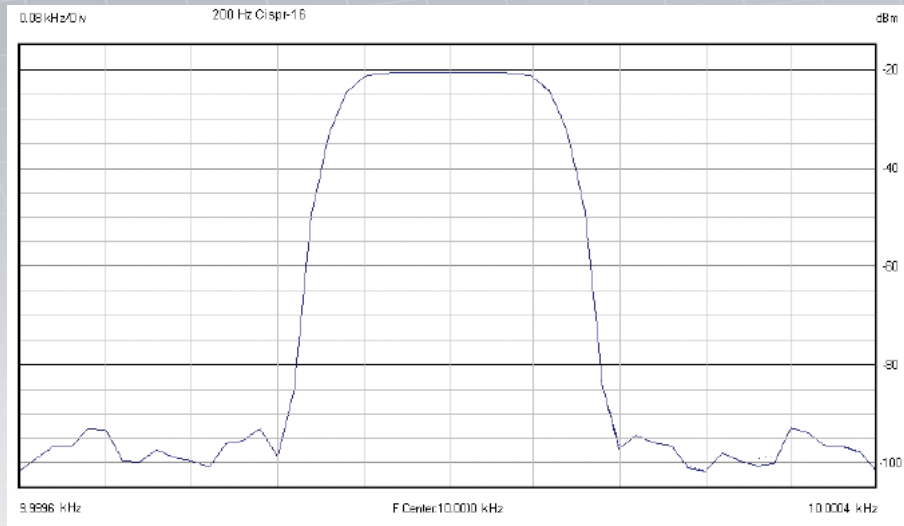

After the A/D conversion the behaviour of a regular receiver is mathematically simulated in order to perfectly match international standards specifications. Even for a digital architecture, preselector filters and input attenuators are mandatory for limiting the signal energy into well defined RF bands, to improve the dynamic range and to increase the signal to noise ratio, thus ensuring accurate measurements of all wideband complex signals typical of EMC measurements.

The input attenuator provides the maximum dynamic range with no distortion. This is particularly important in conducted tests where overloading signals may be present outside the frequency band under test.

To prevent this from happening, the 9010's input attenuator is directly controlled by the DSP in wideband mode to maintain the response linearity in any conditions and also to protect the RF input from out-of-band signals that are too high.

No calibrations and no adjustments are required after the A/D converter: CISPR IF filters and detectors are all mathematically calculated and are thus not subject to any degradation for the life of the instrument. This high performance digital architecture features an ultra-fast A/D converter with the DSP controlling 3

more processors for different functions: RSP, FPGA, CPLD.

The ADC is followed by the Receiver Signal Processor - RSP - that performs most of the analogue-like functions of the receiver and handles all the numeric signals within the digital IF, with the main advantage of this solution directly deriving from the perfection of the mathematic approach: the computing function is equivalent to conventional analogue mixers, but simply cannot generate spurious components which are therefore absent.

The sampled signals are processed by the RSP in a purely mathematical "mixer-like mode", and then applied to FIR (Finite Impulse Response) digital RBW filters: the result is an unbelievably stable filter, a shape controlled to perfection as it is mathematically modelled. Adjustments needed by analogue filters are simply not required.

One of the fastest available DSP not only controls the RSP, but also performs all of the calculations and signal processing, like simultaneous detections and graphical representation, in real time; it controls other functions like the frequency sweep, etc.

The DSP simultaneously applies the mathematical algorithms corresponding to the detectors Peak, CISPR Quasi-Peak, RMS, Average, RMS+AVE whose

response is no longer depends on the input signals, as the detectors always work exactly as intended in perfect time coherent measurements.

Thanks to the high number of operations performed by the DSP - equivalent to those of an ideal 10 GHz Pentium 4™ - the DSP also manages the different operating modes: Sweep Mode, like a traditional receiver with CISPR Limits stored in non-volatile memory, Spectrum and Manual Mode.

The Spectrum Mode allows the receiver to perform spectrum analyzer functions, and thanks to the very high scan speed (<100 ms for full-span 9 kHz-30 MHz @ IF resolution 300 kHz) it is very useful for any kind of debugging.

In Manual Mode the filter in CISPR bands is selected automatically according to the frequency and the data are displayed with a dynamic range up to 120 dB, and the hold time is exactly the integration time theoretically required by the applied detectors.

Moreover, hold time means that the receiver really stops for the preset time, thus taking a perfect picture of the signal under analysis, with no drift depending from on the sweep time.

Block diagram of the 9010 EMI Digital Receiver

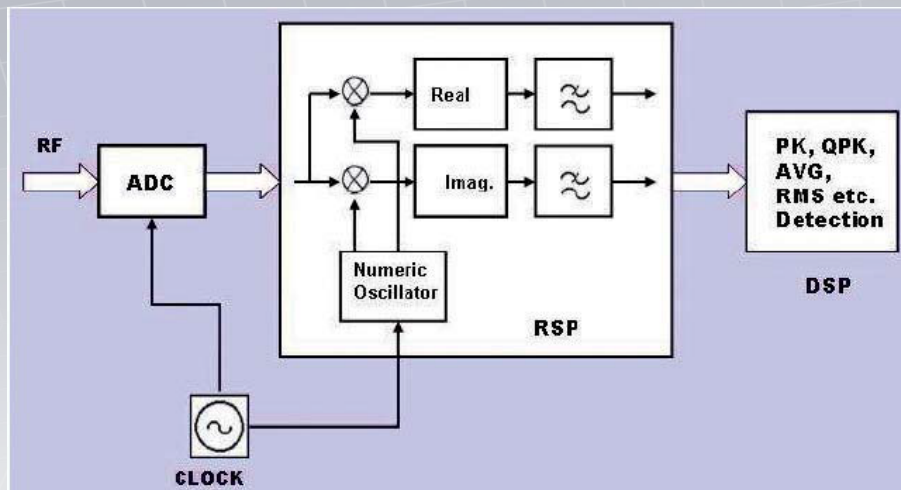

Other RBW filter standards which may be required in future can be easily added: Narda designers will model them mathematically, verify their performances and add them to user-friendly firmware upgrades.

The huge internal memory combined with the capability of making a FFT (Fast Fourier Transform) analysis of the signals allows for an ultra-fast complete scan of the whole A-band (9 to 150 kHz) performed in only 1 second even with the 200 Hz filter.

Even in those cases when the source is on for very short periods of time – or when the source has an extremely short cycle - it is possible to see and measure the emissions.

A clever function - the Smart Detector - dramatically reduces test time and improves productivity: the receiver starts scanning with the fast peak detector then, when the reading is close to a selected limit it immediately turns to quasi-peak detector (or any other selected one), moves some frequency step back and measures with the new detector until the signal returns low; then the receiver turns back in peak mode and continues the scan at the highest possible speed, repeating this process any time there's an over limit peak.

This "performance booster" was first introduced in PMM's receivers in 1990.

To maintain calibration a signal reference is essential: a high stability internal RF Signal Generator (60 to 90 dB $\mu$ V in 0,1 dB steps) has been added to the 9010.

This RF generator can work in tracking mode with the span or set at any frequency in the range of 10 Hz to 50 MHz: in addition to being the main reference for the receiver, it also makes the receiver an easy-to-use scalar network analyzer for characterizing components, antennas, filters etc.

To always keep your receiver perfectly calibrated, just send the generator module back to your Narda Dealer: a terrific advantage in terms of costs and speed.

After recalibration, this single module is easily reinstalled into the receiver to restart operations immediately after.

The 9030, 9030 and 9180 are innovative and different from this stand point: although they need an external frequency reference source for calibration check, the complete RF front-end only - a single, solid block module - can be sent to Factory the same way.

Utilizing a digital receiver implementation, it's easy for such a receiver to integrate a single channel Click Receiver with no additional hardware required: an external option is required only to have a full 4 channels click evaluation.

Moreover, the huge memory of the

receiver (required for storing each disturbance duration and interval and for post-process) is essential to be able to fulfil the recently modified click specifications approved by CISPR.

## Configurations and application examples

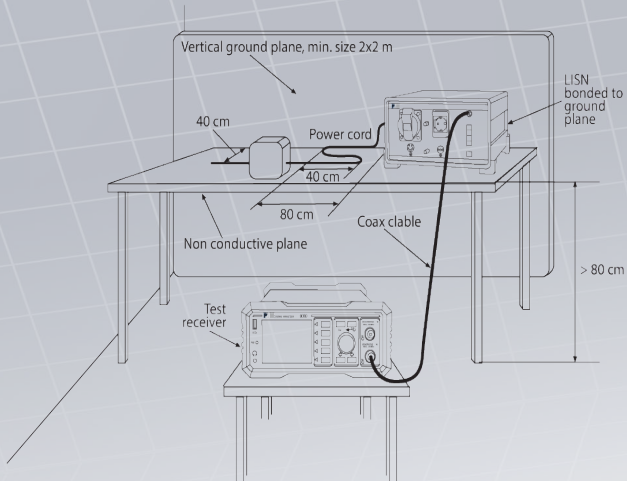

Example of Test Setup for RFI Voltage Measurement

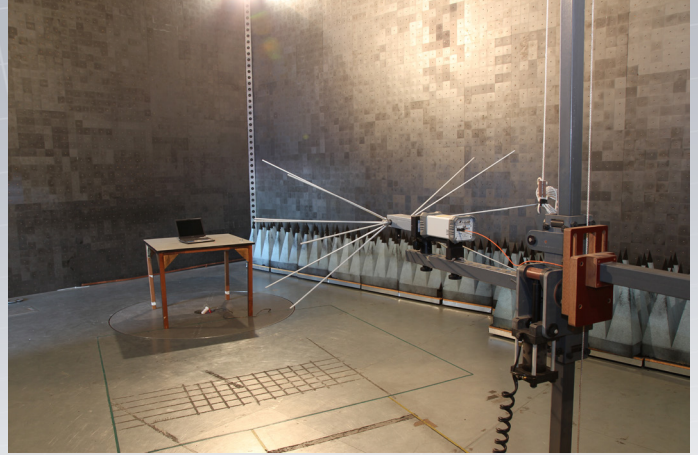

Radiated measurements with 9030/9060/9180 mounted directly on an antenna connector



### 9010

Conducted tests up to 30 MHz Interference measurements with optional rod antenna



### 9010 + 9030

All kinds of conducted and radiated measurements up to 3 GHz (CISPR 11 group 1; CISPR 11 group 2 with operating frequency < 400 MHz; CISPR 12; CISPR 13; CISPR 14-1; CISPR 22 when the highest internal source frequency is up to 500 MHz; future CISPR 32 when the highest internal source frequency is up to 500 MHz)



### 9010 + 9060

Conducted and radiated measurements up to 6 GHz (as above plus: CISPR 22, any frequency of internal source; future CISPR 32, any frequency of internal source but except outdoor units of direct to home satellite receivers)



### 9010 + 9060 + 9180

Conducted and radiated measurements up to 18 GHz (as above plus: CISPR 22, any frequency of internal source; future CISPR 32, any frequency of internal source but except outdoor units of direct to home satellite receivers)

## 9010 as a Discontinuous Disturbance (Click) Analyzer

In the application of measurement of Discontinuous Conducted Disturbances (Clicks) the 9010 EMI receiver equipped with the Click Option not only guarantees full compliance to the latest CISPR-14-1 requirements: thanks to its fully digital structure it offers superior stability and performance as an Automatic Click Analyzer featuring:

- wide memory to store each disturbance duration and interval as required by CISPR-14-1
- automatic evaluation of Click Rate N
- automatic use of Exceptions, if applicable
- automatic Click measurement using Upper Quartile Method
- exclusive Smart Measure function to speed up tests
- real time displaying of all events including click details
- generation of a Report with all mandatory data (and more)

Moreover, the 9010 as a click Analyzer can be tailored to the users' requirements: from the basic single-channel solution, that's embedded in the 9010 hardware and can be ordered and activated by the user at any time, up to the full four-channel configuration consisting of an external unit to connect to the 9010 Receiver (single-channel Click option required).

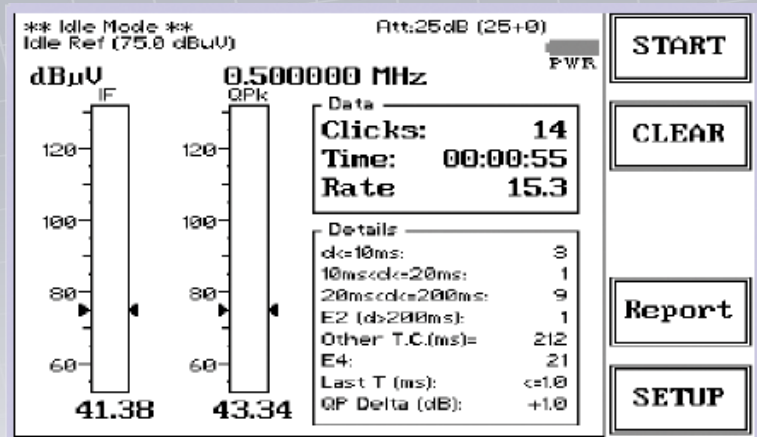

Worst Line Search										
Line	Limit	10ms	20ms	0.2s	E4	o.t.c	Total	Time	N	Worst
L3-1	75.0	3	1	5	0	1203	9	1.0	9.1	X
L3-2	75.0	2	0	0	0	241	3	0.2	17.2	.
L3-3	75.0	1	0	0	0	0	1	0.1	10.5	.
L3-N	75.0	0	0	9	0	0	9	0.4	24.1	.

Lq Calculation										
Freq	Limit	10ms	20ms	0.2s	E4	o.t.c	Total	Time	N	+Lq
0.15	75.0	0	0	4	0	335	5	0.4	12.2	7.8
0.50	75.0	6	0	2	0	0	8	0.5	15.5	5.7

Final Test Report										
Freq	Lq	10ms	20ms	0.2s	E4	o.t.c	Total	Time	Max	F/F
0.15	82.8	0	0	0	0	0	0	0.4	1	Pass
0.50	80.7	0	0	0	0	0	212	0.5	2	Pass
1.40	80.7	0	0	0	0	0	0	0.5	2	Pass
30.00	80.7	0	0	0	0	0	0	0.5	2	Pass

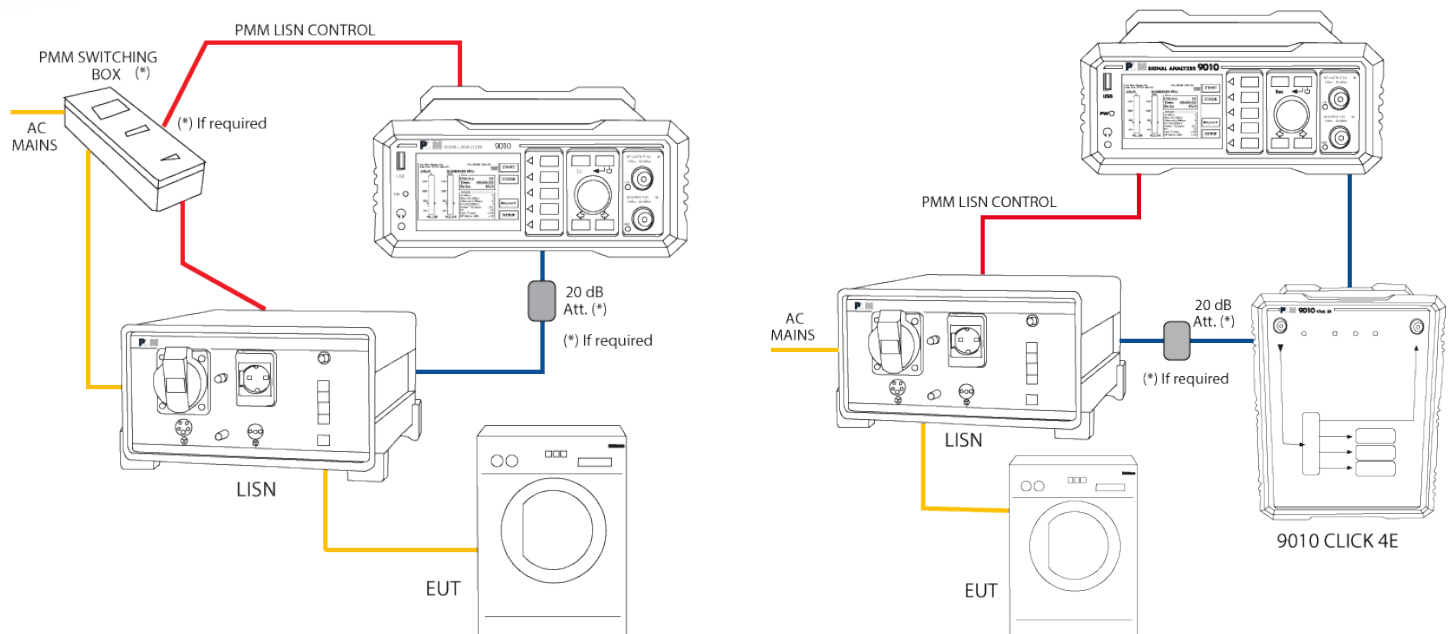

## 9010 - 9030 - 9060 - 9180 Emission Suite PC software

The PMM Emission Suite comes with PMM EMI receivers for user-friendly operation as never seen before:

- Full control of all auto and manual Receiver functions
- Real-time display on PC
- One-click operating mode change : Scan/Sweep, Analyzer, Manual
- Import and creation of Limits
- Import and creation of Correction Factors Tables for ancillary equipment (antennas, cables etc.)
- Retrieve, save, recall and compare measurements
- Simultaneous Marker on all Detectors and Zoom
- "n" Highest Peaks Finder and Scan Table generation
- Measured LISN lines scrolling by mouse wheel
- Functions specific to Lighting Equipment (IEC/EN55015, IEC62493)
- 2D - 3D Waterfall and time analysis (option)
- GTEM correlation to OATS (for radiated measurements)
- Warning messages for incorrect settings
- Report generation
- Import-export of complete measurements
- Mast-table control (option)

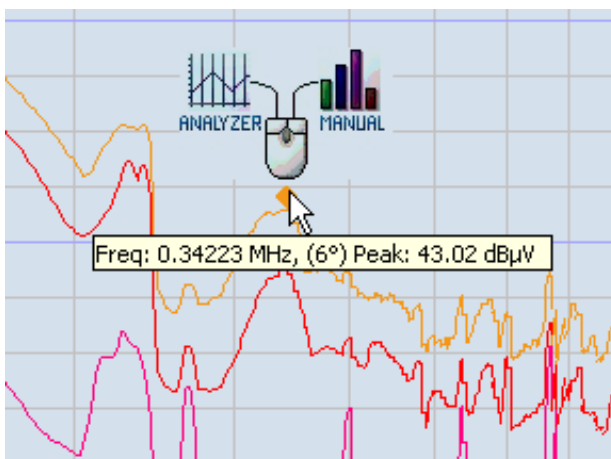
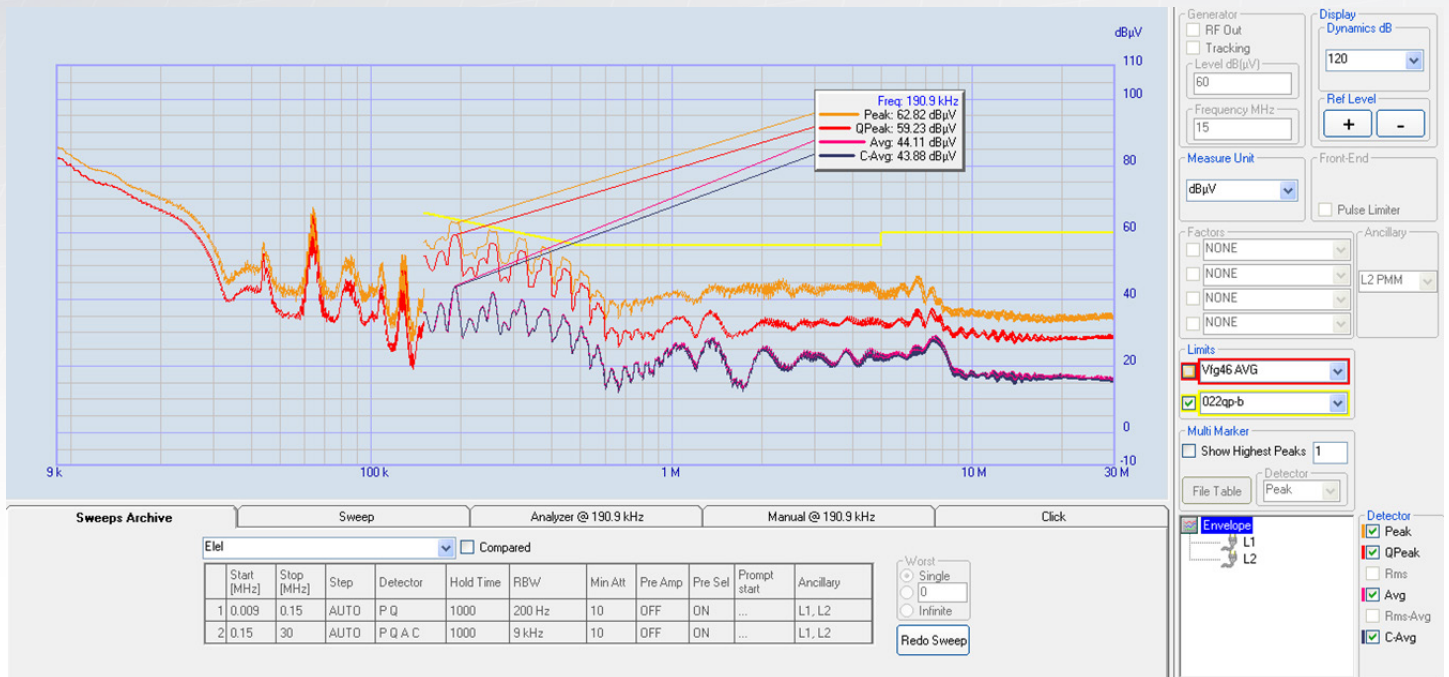

Just one click to move across functions



### Powerful, clear scan table

Start [MHz]	Stop [MHz]	Step	Detector	Hold Time	RBW	Min Alt	Pre Amp	Pre Sel	Prompt start	Ancillary
1 76	108	AUTO	P.A	50	120 kHz	0	OFF	ON	VHF	...
2 174	241	AUTO	P.A	50	1 MHz	0	OFF	ON	DAB	...
3 1452	1492	AUTO	P.A	50	1 MHz	0	OFF	ON	DAB-L	...
4 2320	2345	AUTO	P.A	5	1 MHz	0	OFF	ON	SDARS	...
5 47	88	AUTO	P.A	50	1 MHz	0	OFF	ON	TVI	...

### Easy setting of limits by bands

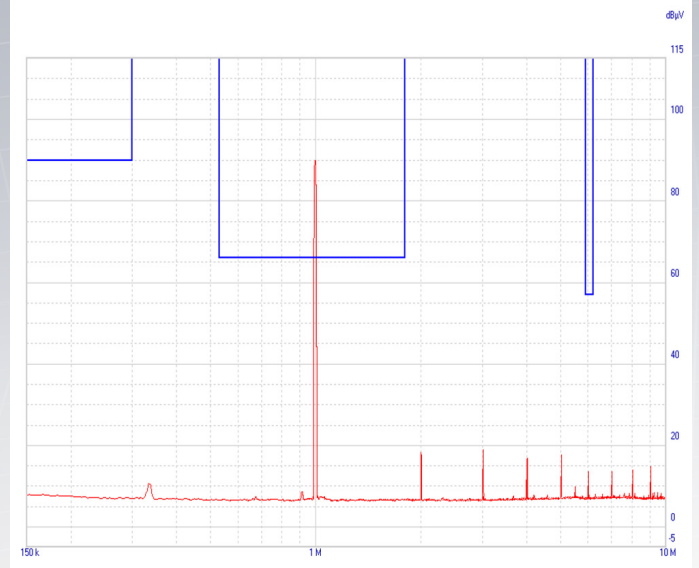

### Creation of frequency tables from "N" highest peaks

**Frequency Table**

	Frequency MHz	Level dBµV
1	0.3136	19.15
2	1.072295	12.86
3	1.83099	12.18
4	2.749195	5.40
5	5.501765	11.36
6	5.804425	6.24
7	6.000745	75.96
8	11.99873	32.62
9	17.99876	37.87
10	29.99882	11.47

Multi Marker  
 Highest Peaks  
 10

File Table  
 CAvg

Remove row 1

Save Save as text Save as PDF Load from text Load Exit

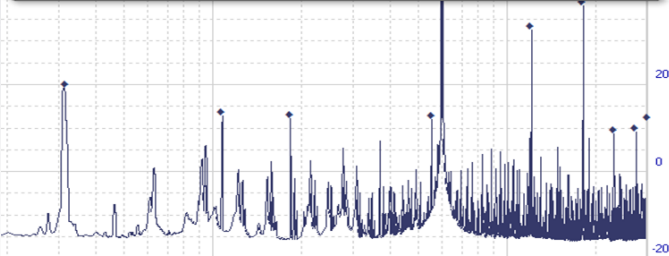

### Generation of customizable reports

Company name   
 Report issuing date : --/--/----  
 EUT ----- Receiver -----  
 Manufacturer ----- Model -----  
 Model ----- S/N -----  
 S/N ----- Last Calibration -----  
 Notes ----- Ancillary -----  
 Operator ----- Model -----  
 S/N -----  
 Last Calibration -----

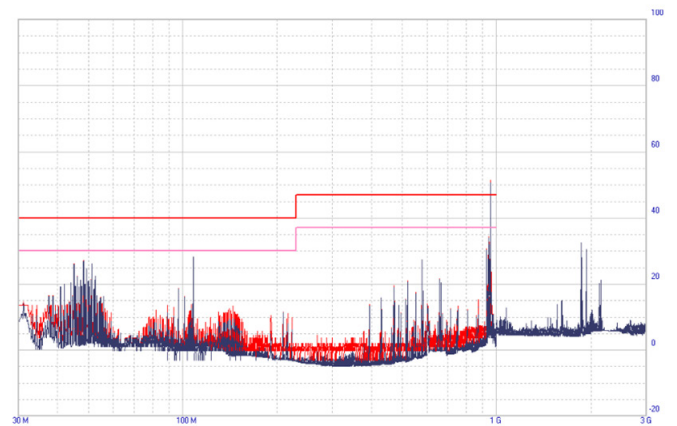

Start [MHz]	Stop [MHz]	Step	Detector	Hold Time	RBW	Min Alt	Pre Amp	Pre Sel	Prompt start	Ancillary
1 30	1000	AUTO (100 kHz)	P.F R A N C	0.2 ms	120 kHz	10	ON	ON	...	...
2 1000	3000	AUTO (250 kHz)	P.A C	Lowest	1 MHz	10	ON	ON	...	...
3 50	120	AUTO (100 kHz)	P.C	0.2 ms	120 kHz	10	ON	ON	...	...

Ancillary = General  
 Limit: <200pp3m (red line)  
 <200pp10 (blue line)

Margin: 3 dB

Frequency [MHz]	Peak [dBµV]	Limit c22bqp3m [dBµV]	Delta QPeak [dB]	Limit c22bqp10 [dBµV]	Delta C-Avg [dB]
1 48.2	28.54	40.00	---	30.00	-2.92
2 48.4	6.49	40.00	---	30.00	-2.92
3 107.7	-1.47	40.00	---	30.00	-1.75
4 955.3	3.80	47.00	4.44	37.00	13.76
5 107.7	-0.13	40.00	---	30.00	-1.97

### Displaying of up to 5 arbitrary limits



## Examples of basic functions

### Spectrum Analyzer mode

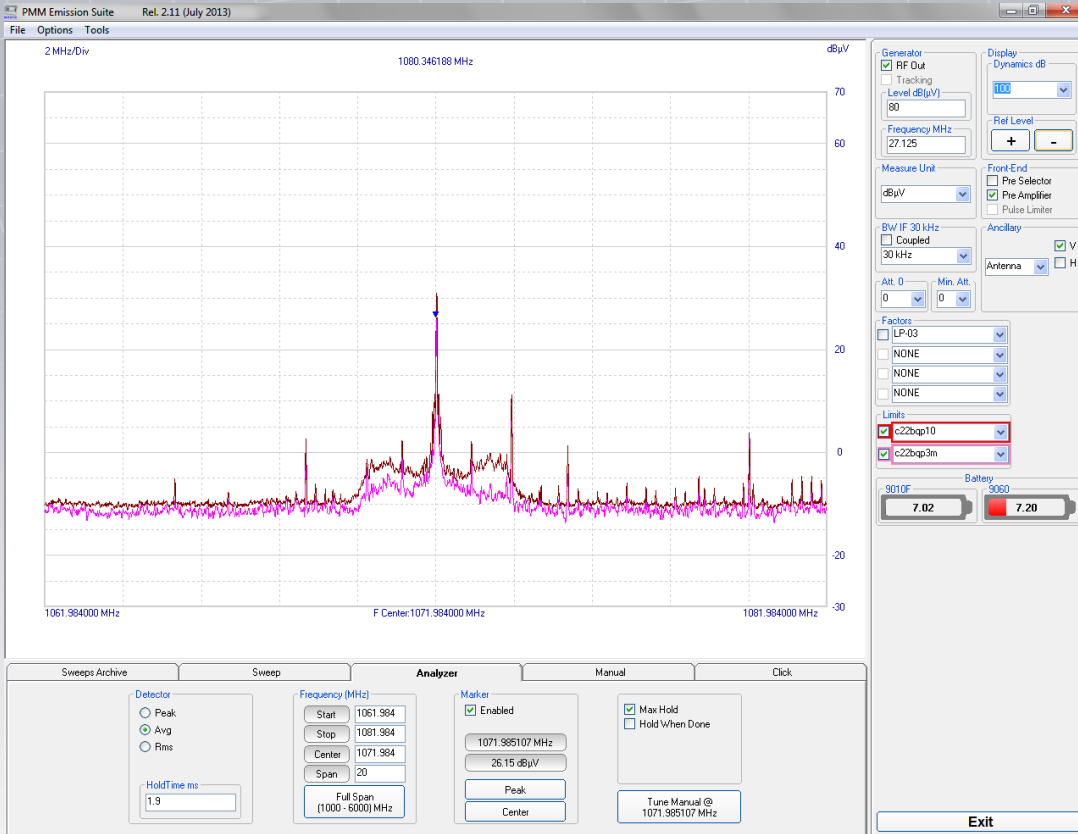

### Manual mode

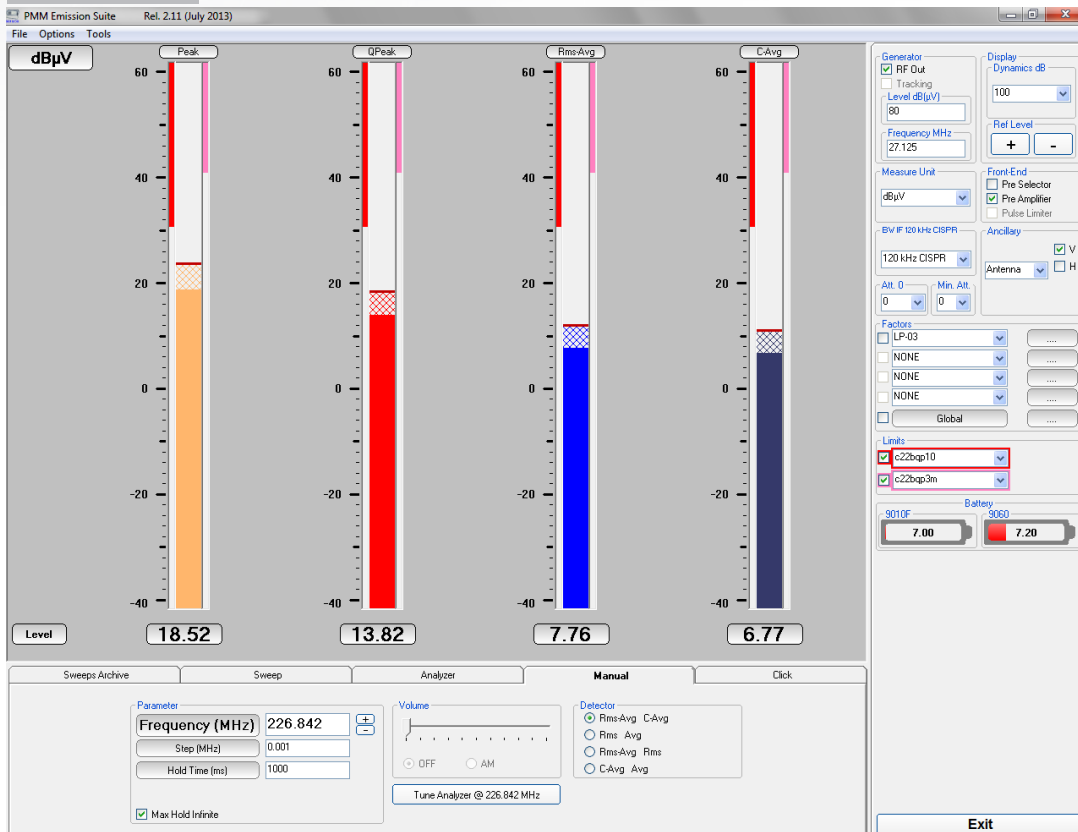

## Examples of dedicated functions

### IEC 62493

IEC 62493 requires the exposure of humans to the EMF generated by lighting devices to be assessed by measuring the RF field with a dedicated sensor - the Van der Hoofden Test Head - and by calculating an adimensional quantity to be confronted with the reference limit. PMM Emission Suite makes it all automatically and safely, in few clicks!

A standard feature of PMM Emission Suite,

	Start [MHz]	Stop [MHz]	Step	Detector	Hold Time	RBW	Min Alt	Pre Amp	Pre Sel
1	0.02	0.15	220 Hz	P	100	200 Hz	0	OFF	ON
2	0.15	10	10 kHz	P	20	9 kHz	0	OFF	ON

### G-TEM correlation

According to the EMC Standard EN 61000-4-20, measurements obtained from TEM/G-TEM cells by an EUT rotated along its x-y-z axis can be correlated to those obtained in an OATS (Open Area Test Site) by specific algorithms. The G-TEM correlation function correlates in few clicks the x-y-z measurements into a final measurement spectrum that can be compared with the limits. A standard feature of PMM Emission Suite,

### Turntable and antenna mast control (option)

This function provides an intuitive but complete setting of two-step - pre-scan and scan - automatic measurements of radiated emissions by controlling the antenna mast and the turntable via GPIB (external controller required - check for the compatibility).

When debugging the antenna and turntable positioning can be set manually and the receiver operated in Manual and Analyzer modes.

## SIMULTANEOUS TIME & FREQUENCY DOMAIN ANALYSIS

An optional function of PMM Emission Suite for collecting subsequent spectra displayed in 3-D: frequency, amplitude and time, to see at a glance the variations of the spectral components during time.

This allows for an immediate correlation of the disturbance with the EUT operating cycles, e.g. during its run up - run down phases, and generally for recognizing intermittent disturbances.

The time history of the spectra can be displayed in two ways:

Waterfall diagram, particularly useful when the spectral contents are relatively limited, e.g. in presence of narrowband disturbances

Spectrogram, showing the peaks amplitude with different colors, more useful for complex, broadband disturbances

The time history can cover several hours; the cursor gives full information of each single peak. Display commands include size, scrolling, orientation, dynamic, color management.

Purchase of activation code required.

Waterfall diagram

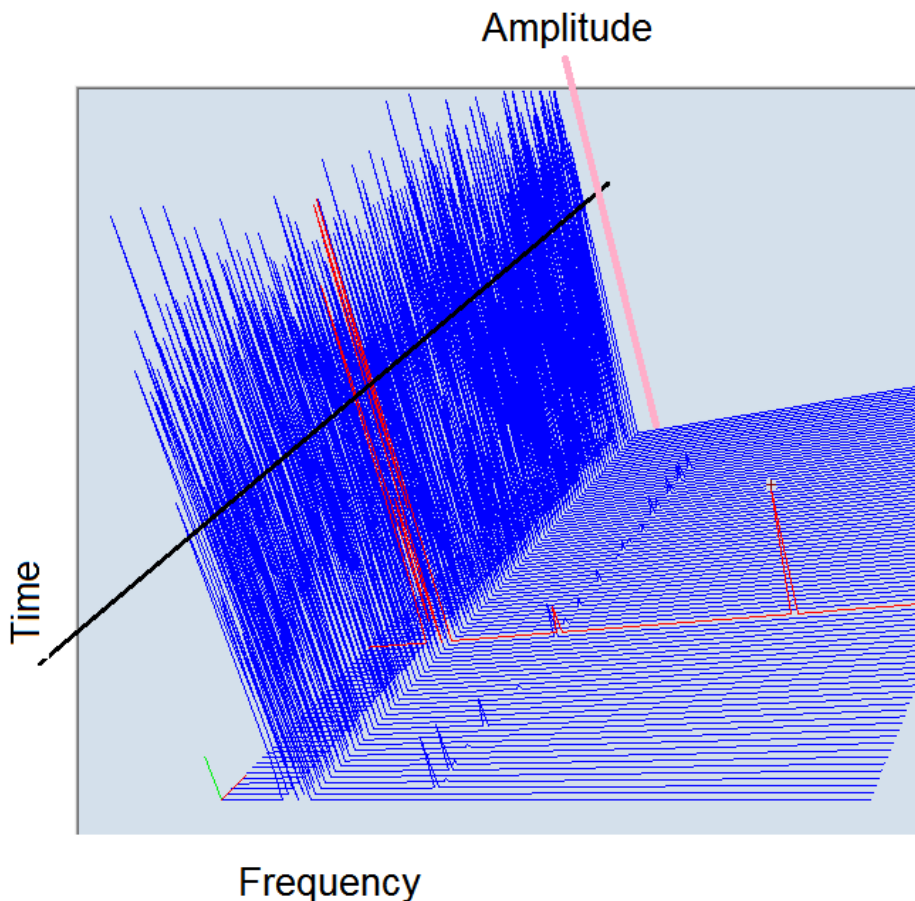

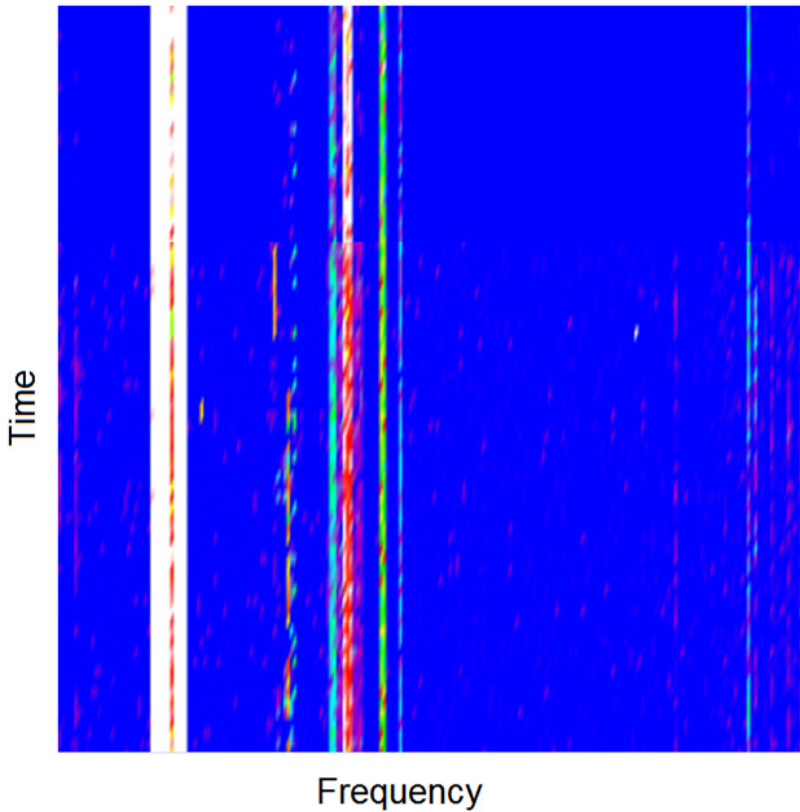

Amplitude = color depth

Spectrogram diagram

## Time history of a single frequency

When a specific frequency is selected by the marker (left) its changes of amplitude during time can be displayed and measured, for an immediate correlation with the EUT operation or cycle that may generate the disturbance.

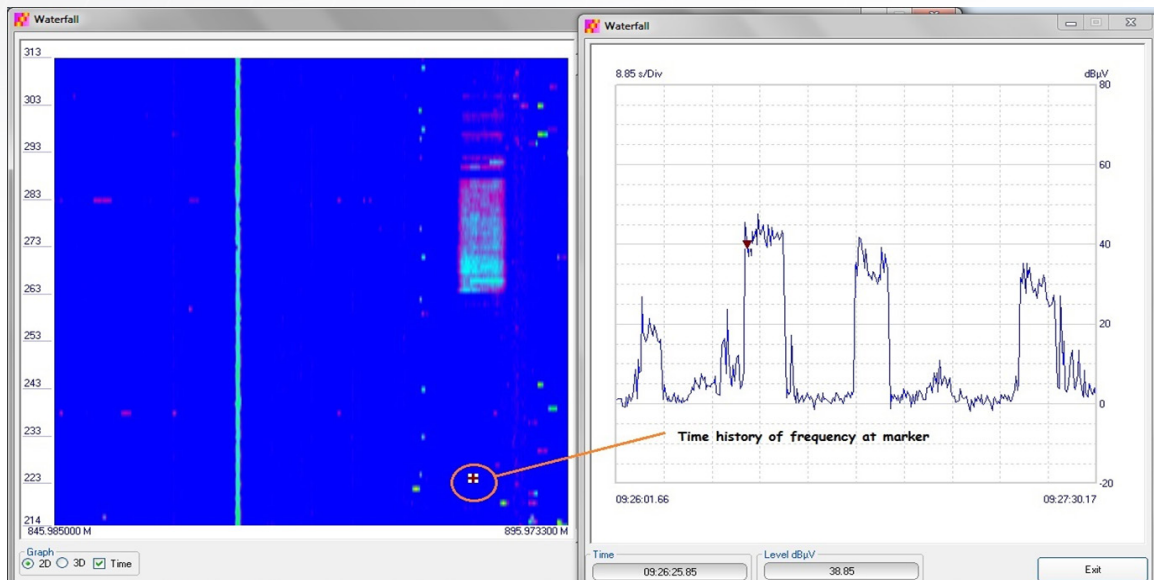

## User-upgradeable Firmware

A simple utility included in the PMM Emission Suite CD allows the user to upgrade the firmware of his own PMM receiver whenever required by future standards, measuring features and test solutions. A dedicated operating system allows the 9010 to be ready to use just few seconds after power on.

An exclusive "parking memory" makes upgrading the PMM Receivers Firmware totally failsafe against unexpected interruptions that may occur during downloading.

## Technical Specifications

### 9010 - CISPR 16-1-1 & MIL-STD-461F Compliant

<b>Frequency range</b> Resolution Reference frequency	10 Hz to 30 MHz 0,1 Hz < 1 ppm	<b>Display units</b>	dBm,dBμV, (dBμA,dBpW,dBμV/m, dBμA/m by PMM Emission Suite)
<b>RF input</b> VSWR 10 dB RF att. 0 dB RF att. Attenuator Preamplifier gain Pulse limiter	Zin 50 Ω, BNC fem. < 1,2 < 2 0 dB to 35 dB (5 dB steps) 20 dB (after preselector) Built in (selectabl	Displayed dynamic	80, 100, 120 dB selectable
<b>Max input level</b> (without equipment damage) Sinewave AC voltage Pulse spectral density	137 dBμV (1 W) 97 dBμV/MHz	<b>Spectrum Analyzer mode</b> Span/division	100 Hz ÷ 3 MHz
<b>Preselector</b> Frequency ranges	(One LP and six BP filters) < 9 kHz 9 kHz to 150 kHz 150 kHz to 500 kHz 500 kHz to 3 MHz 3 MHz to 10 MHz 10 MHz to 20 MHz 20 MHz to 30 MHz	<b>Measurement accuracy</b>	S/N > 20 dB 10 Hz to 9 kHz ±1,0 dB Typ. 9 kHz to 30 MHz ±1,0 dB
<b>IF bandwidth</b> 3 dB bandwidth 6 dB bandwidth	3, 10, 30, 100, 300 kHz 0,2 and 9 kHz (CISPR 16-1-1) 10, 100 Hz; 1,10 kHz (MIL-STD-461) (100 kHz, 1 MHz MIL-STD-461 when operated with 9030 or 9060)	<b>RF output</b> Tracking & CW Generator. Frequency range Level Level accuracy (10 Hz to 30 MHz)	Zout 50 Ω, BNC fem  10 Hz to 50 MHz 60 to 90 dBμV (0.1 dB step)  ± 0,5 dB
<b>Noise level</b> (Preamplifier ON)	9 - 150 kHz < -8 dBμV (QP) (200 Hz BW) < -15 dBμV (AV)  0,15 - 30 MHz < -4 dBμV (QP) (9 kHz BW) < -10 dBμV (AV)	<b>Demodulation</b>	AM; volume setting by knob
<b>Detectors</b> (simultaneous on PMM Emission Suite)	Peak, Quasi-Peak, Average, RMS, RMS-Average (*), C-Average, APD Smart Detector function	<b>Autocalibration</b>	Internal reference source
<b>Level measuring time</b> (Hold time)	CISPR 16-1-1 as default Variable, 1 ms to 30 sec.	<b>I/O Interface</b>	RS-232 High Speed Optical (2 channels; 2nd for future extension) USB Rear USB Front (future extension) User Port (drives PMM LISNs) Bluetooth (optional) IEEE-488 (optional)
<b>Stand-alone display &amp; measure functions</b>	Marker; marker peak; marker to center; highest peaks;move peak to Analyzer & Manual modes Store & Load: - up to 11 traces (sweep mode) - two panels - 4 conversion factors Built-in limits: CISPR 11, 14, 22 Battery charge and voltage Display style, contrast, backlight Click functions (option required)	<b>Click meter</b> (Optional)	1 to 4 simultaneous channels Full compliant to EN 55014-1
		<b>Operating temperature</b>	0° to 40°C
		<b>Power supply</b>	10 - 15 Vdc, 2.5A Li-Ion rechargeable plug-in battery (8h avg. duration) AC universal adapter/charger
		<b>Dimensions</b>	235x105x335 mm
		<b>Weight</b>	4,1 kg

(\* ) RMS-Average detector manufactured under license of Rohde & Schwarz GmbH & Co. KG



## 9030 - 9060 - 9180 (CISPR 16-1-1 & MIL-STD-461F Compliant)

	9030	9060	9180
<b>Frequency range</b> Resolution Frequency accuracy	30 MHz to 3 GHz 100 Hz < 2 ppm	30 MHz to 6 GHz 100 Hz < 2 ppm	6 GHz to 18 GHz 100 Hz < 2 ppm
<b>RF input</b>  VSWR 10 dB RF att. 0 dB RF att.  Attenuator  Preamplifier Gain	Zin 50 Ω, N fem.  < 1.2 < 1.2  0 dB to 55 dB (5dB steps)  10 dB (selectable)	Zin 50 Ω, N fem  < 1,2; <2 over 1 GHz; <2; <3 over 3 GHz  0 dB to 55 dB (5dB steps)  20 dB; 15dB above 1 GHz	Zin 50 Ω, N fem  < 2 < 3  0 dB to 45 dB (5 dB steps)  20 dB
<b>Max input level</b> (without equipment damage) Sinewave AC voltage Pulse spectral density	137 dBμV (1 W) 97 dBμV/MHz	137 dBμV (1 W) 97 dBμV/MHz	137 dBμV (1 W)
<b>Preselector</b>	Three tracking filters and one band-pass filter  30,0 MHz to 96,6 MHz 96,6 MHz to 311,0 MHz 311,0 MHz to 1,0 GHz	Four tracking filters and two bandpass filters  30,0 MHz to 72,0 MHz 72,0 MHz to 173,0 MHz 173,0 MHz to 416,0 MHz 416,0 MHz to 1 GHz 1 GHz to 3 GHz 3 GHz to 6 GHz	6 GHz to 9 GHz 9 GHz to 12 GHz 12 GHz to 15 GHz 15 GHz to 18 GHz
<b>IF bandwidth</b> 6 dB bandwidth CISPR 16-1-1 bandwidth (6 dB)	3, 10, 30, 100, 300 kHz, 1 MHz (Bimp) 120 kHz 1 MHz (CISPR 16-1-1) B-imp / MIL-STD 6 dB	3, 10, 30, 100, 300 kHz, 1 MHz (Bimp) 120 kHz 1 MHz (CISPR 16-1-1) B-imp / MIL-STD 6 dB	3, 10, 30, 100, 300 kHz 9, 120 kHz – 1 MHz
<b>Noise level</b> (Preamplifier OFF)	30 to 300 MHz <5 dBμV (QP); (120 kHz BW) < 1 dBμV (AV)  300 MHz to 3 GHz < 8 dBμV (QP) (120 kHz BW) < 4 dBμV (AV)	30 to 300 MHz < 10 dBuV (QP) (120 kHz BW) < 7 dBuV (AV)  300 to 3000 MHz < 13 dBuV (QP) (120 kHz BW) < 7 dBuV (AV)  3000 to 6000 MHz < 15 dBuV (QP) (120 kHz BW) < 10 dBuV (AV)	6 to 18 GHz < 28 dBuV (P) (1 MHz BW) < 22 dBuV (AV)
(Preamplifier ON)	30 to 300 MHz < -1 dBμV (QP); (120 kHz BW) < -5 dBμV (AV)  300 MHz to 3 GHz < 2 dBμV (QP); (120 kHz BW) < -2 dBμV (AV)	30 to 300 MHz < - 20 dBuV (AV) (10 kHz BW)  300 to 3000 MHz < - 18 dBuV (AV) (10 kHz BW)  3000 to 6000 MHz < - 12 dBuV (AV) (10 kHz BW)	6 to 18 GHz < -12 dBuV (P) (10 kHz BW) < -17 dBuV (AV)
<b>Spurious response</b>	< 10 dBuV, < 15 dBuV above 1 GHz	< 10 dBuV, < 15 dBuV above 2 GHz	< 20 dBuV
<b>Measurement accuracy</b> S/N > 20 dB	± 1,0 dB	30 to 1000 MHz ± 1.0 dB 1 to 3 GHz ± 1.5 dB 3 to 6 GHz ± 2.0 dB	6 to 18 GHz ± 2.0 dB
<b>I/O Interface</b>	High Speed Optical Link; RS232 (service only)	High Speed Optical Link; RS232 (service only)	High Speed Optical Link; RS232 (service only)
<b>Operating temperature</b>	0° to 40°C	0° to 40°C	-5° to 45°C
<b>Power Supply</b>	10 - 15 Volt DC, 2,5A; Li-Ion interchangeable battery (4 h operations, average); AC universal adapter/charger	10 - 15 Volt DC, 2,5A; Li-Ion interchangeable battery (4 h operations, average); AC universal adapter/charger	10 - 15 Volt DC, 2,5A; Li-Ion interchangeable battery (4 h operations, average); AC universal adapter/charger
<b>Dimensions</b>	235 x 105 x 105 mm	235 x 105 x 335 mm	235 x 105 x 335 mm
<b>Weight</b>	2 kg	2,2 kg	2,2 kg

## Ordering Information

9010	EMI receiver 10 Hz to 30 MHz, CISPR 16-1-1 full-compliance 9 kHz to 30 MHz, including: - internal tracking generator - battery pack, AC adapter/charger - PC software PMM Emission Suite - Control cables (USB, RS-232), BNC-BNC cable
9030	Extension unit 30 MHz to 3 GHz for model 9010, CISPR 16-1-1 full-compliant, including: - 20 m fiber optic cable - battery pack with charger - antenna holder with adapters for BC-01, LP-02 and other models (ref. to manual) - N-male-N-male; N-male-BNC fem. adapters - SPA-01, plug-in AC supply adapter (replaces battery) for continuous operation
9060	Extension unit 30 MHz to 6 GHz for model 9010, CISPR 16-1-1 full-compliant, including: - 20 m fiber optic cable - battery pack with charger - antenna holder with adapters for BC-01, LP-02 and other models. (ref. to manual) - N-male-N-male; N-male-BNC fem. adapters - SPA-01, plug-in AC supply adapter (replaces battery) for continuous operation
9180	Extension unit 6 GHz to 18 GHz for model 9010, CISPR 16-1-1 full-compliant, including: - 20 m fiber optic cable - battery pack with charger - N-male-N-male; adapters - SPA-01, plug-in AC supply adapter (replaces battery) for continuous operation
9010/UKAS	CISPR-16-1-1 accredited calibration certificate for 9010
9030/UKAS	CISPR-16-1-1 accredited calibration certificate for 9010 & 9030
9060/UKAS	CISPR-16-1-1 accredited calibration certificate for 9010 & 9060
9180/UKAS	CISPR-16-1-1 accredited calibration certificate for 9010 & 9180
9010/UKAS-Click	UKAS accredited calibration certificate for 9010 + 9010/Click according to CISPR-16-1-1 & CISPR-14-1

## Optional Accessories and Functions

9010/MIL	MIL-STD-461F RBW Filters
9010/RAV	CISPR RMS-AVG detector
9010/CLICK	1-channel Click Analyzer function, CISPR 14-1: 2005 full-compliance, including: - Switching Operation Box, control cables, 2x20 dB attenuator NOTE: field-installable function (advice 9010 S/N for upgrading confirmation)
9010/CLICK4E	External box to connect to a receiver 9010 equipped with 9010/click option. Allows four-channel simultaneous click measurements according to CISPR-14-1-1. AC power only.
9010/BTA	RS-232 to Bluetooth adapter for 9010
9010/GPIB-232CV-A	RS-232 to GPIB (IEEE-488) external adapter for 9010
BP01	Spare Li-Ion Battery Pack for 9010, 9030, 9060 or 9180
9010/AC	AC adapter/charger for BP01, 9010, 9030, 9060 or 9180
9010/FO-xx	20, 50 or 100 m fiber optic cable for 9030, 9060 or 9180
9010/CC	Rigid carrying case for 9010
9010/RMA	19" Rack mount adapter for 9010 Series and 3010, 3030
PES/WF	Waterfall and Spectrogram function of PES-PMM Emission Suite
PES/TM	Table and Mast control function of PES-PMM Emission Suite (Check controller availability)

## Ancillary equipments

LISN controlled by the 9010F receiver to automatically the lines to measure	<ul style="list-style-type: none"> <li>• L1-150M: single-path, 50 Ohm AMN, 150 A</li> <li>• L1-150M1: single-path, 50 Ohm AMN, 150 A</li> <li>• L1-500: single phase AMN, 500 A</li> <li>• L2-16B: single phase AMN, 16 A</li> <li>• L3-32: 4 lines, 3-phase AMN, 32 A</li> <li>• L3-64: 4 lines, 3-phase AMN, 63 A</li> <li>• L3-64/690V: 4 lines, 3-phase AMN, 63 A</li> <li>• L3-100: 4 lines, 3-phase AMN, 100 A</li> <li>• L3-500: 4 lines, 3-phase AMN, 500 A</li> <li>• L2-D: Delta LISN for telecom, 2 A, 150 Ω</li> </ul>
CISPR 16-1-2	<ul style="list-style-type: none"> <li>• SHC-1/1000: Voltage probe, 1000 Vac, 35 dB</li> <li>• SHC-2/1000: Voltage probe, 1000 Vac, 30 dB</li> </ul>
Antennas	<ul style="list-style-type: none"> <li>• RA-01: Rod Antenna 9 kHz to 30 MHz</li> <li>• RA01-HV: Rod Antenna 150 kHz to 30 MHz</li> <li>• RA01-MIL: Rod Antenna 9 kHz to 30 MHz</li> <li>• BC-01: Biconical Antenna 30 to 200 MHz</li> <li>• DR-01: Double-ridged Antenna 6 to 18 GHz</li> <li>• LP-02: Log Periodic Antenna 200 MHz to 3 GHz</li> <li>• LP-03: Log Periodic Antenna 800 MHz to 6 GHz</li> <li>• VDH-01: Van der Hoofden test-head 20 kHz to 10 MHz</li> </ul>
EN55015 (CISPR 15) components	<ul style="list-style-type: none"> <li>• F-330M-16: CDN 150 kHz to 30 MHz; 250VAC - 16A; 50/60 Hz for power circuitry testing with phase, neutral and PE</li> <li>• TRF-1: Balance/unbalance transformer</li> <li>• SBRF4: X-Y-Z Switching Box for automatic operation of RF-300</li> <li>• RF-300: 3-axis Loop Antenna System For CISPR 15 EN55015</li> <li>• RF-300C: Calibration kit for RF-300</li> <li>• DL-xx: Dummy Lamps according to the standard</li> </ul>

The 9010 can also be used with other accessories available on market: LISN, any type; Antennas and Loops; Near Field Probes; TEM/GTEM Cells