

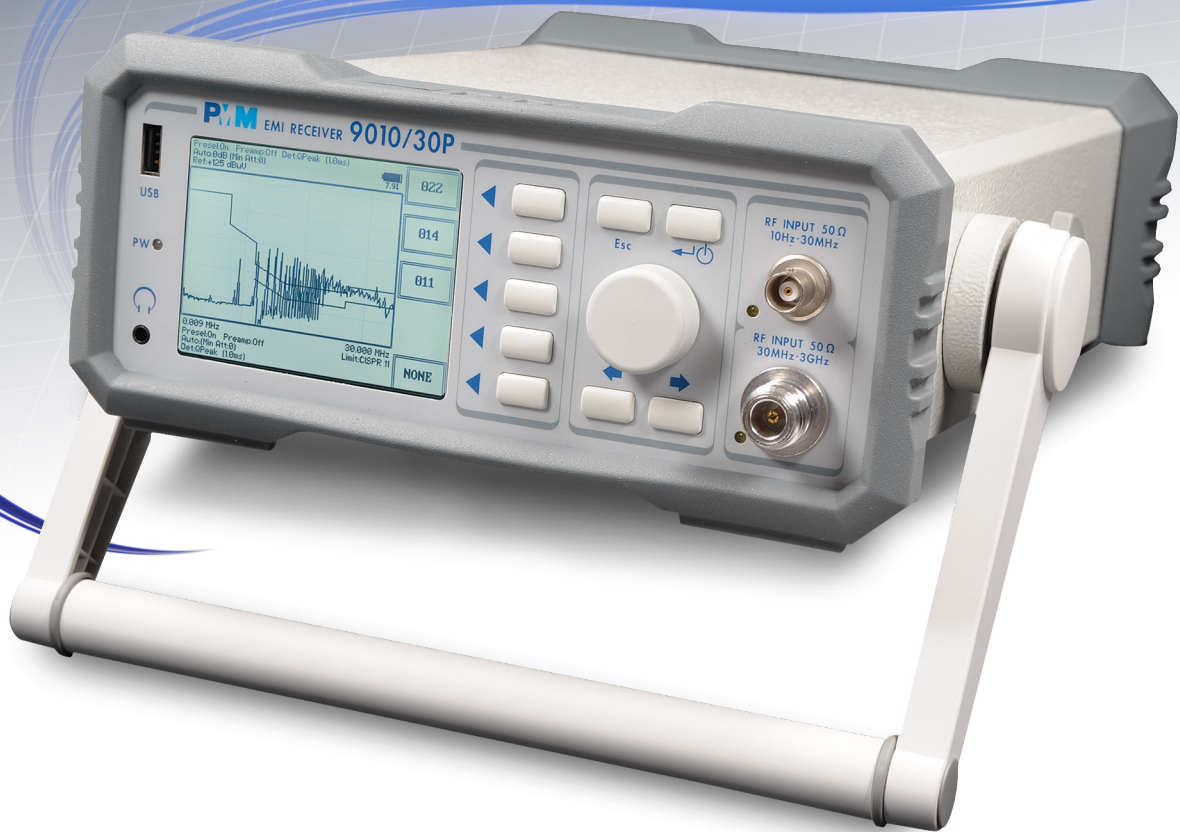

narda

Safety Test Solutions[®]

an  Communications Company



EMI Measuring Receiver & Analyzer
9010/03P 10 Hz/300 MHz
9010/30P 10 Hz/3 GHz
9010/60P 10 Hz/6 GHz

9010/03P
9010/30P
9010/60P

One instrument, many applications

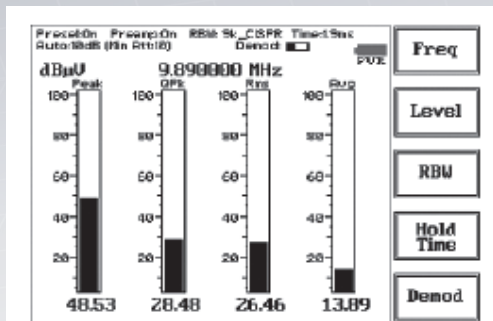

Manual mode

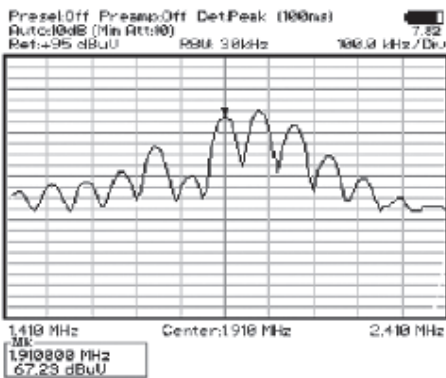

Spectrum mode

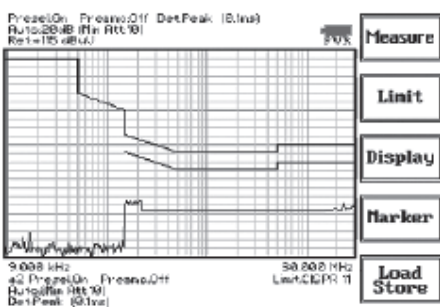

Sweep/scan mode

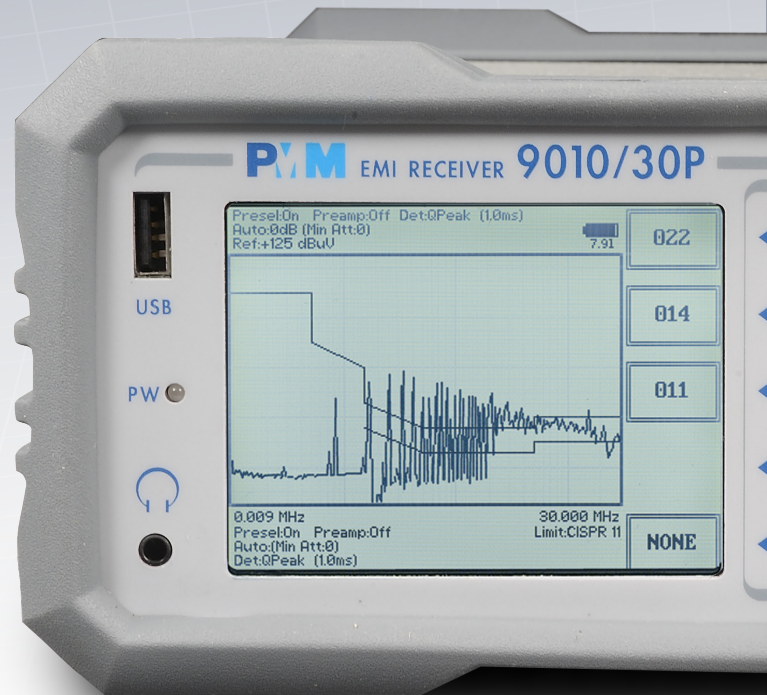

Conducted emissions can be the most critical part of the interference to measure, particularly for industrial equipments and household appliances with switching power supplies, motors, contactors, speed regulators etc. General purpose and pre-test instruments may be quite ineffective for correct evaluation of such complex disturbance signals; meantime, building a fullcompliant test setup is accessible to all (see example at page 4). the 9010/03P, 9010/30P and 9010/60P feature full-compliance to CISPR-16-1-1 andMIL-STD 461 for conducted measurements from 10 Hz up to 30 MHz. The required accessories are summarized at page 10.



REVOLUTIONARY CONCEPT
9010/03P, 9010/30P and 9010/60P are the first EMI Receivers that fits in any budget and grows with your needs:

- On-field expandable to Radiated Full Compliance (see page 6)
- Safe and easy Firmware and Software upgrading from Web
- Digital Technology for best reliability
- Reduced turnaround time and cost for periodic re-calibration
- Full choice of Ancillary Equipments
- PEMS - PMM Emission Suite included
- Small size, lightweight, AC/DC and battery for portable operation

10 Hz—30 MHz RF input

30 MHz - 300 MHz RF input,
30 MHz - 3 GHz RF input,
30 MHz - 6 GHz RF input,
it depends on the model

Radiated emissions may require specific setups to be performed in full compliance mode, e.g. in an anechoic chamber; viceversa pre-test measurements can be carried out with less expensive methods (see example at page 5).

A specifically designed pre-test EMI Receiver like the PMM 9010/03P, 9010/30P and 9010/60P used in debugging can significantly improve the results and speed up the development time of new products.

PMM 9010/03P, 9010/30P and 9010/60P have High Frequency section allows for Radiated Emissions pre-testing in the frequency range up to 6 GHz, featuring all the CISPR and MIL-STD RBW filters and Detectors, including those of recent introduction in standards (C-AVG, RMS AVG, APD).

UNIQUE FEATURE: upgrade the frequency range from 300 MHz to 3 or 6 GHz when you need it, and save your money!

9010/03P
9010/30P
9010/60P

Conducted

Conducted emission in Full Compliance mode

Reference Standard	Generic Standards	Product Standards
Receiver: CISPR 16-1-1 AMN (Artificial Mains Network) Voltage & Current Probes CISPR 16-1-2	IEC61000-6-3 IEC61000-6-4 EN... MIL-STD 461 Interference Voltage	EN 55011-CISPR 11 EN 55014-CISPR 14 EN 55015-CISPR 15 EN 55022-CISPR 22 Interference Voltage 0,15 30 MHz
Remark: All above Standards appears as undated for the PMM 9010/30P can be updated to future changes		

Typical set-up configuration for EMI conducted measurements; construction details can be found in CISPR-16-1-2. Its realization can be afforded by most of the laboratories and industries with limited costs.

TIPS:

- Care perfect groundings: loose or longer connections are likely to cause severe measuring errors
- Replace any cable looking crushed, overbent or scratched
- Make sure of all connections being tightened and efficient
- Make sure that LISNs are compliant to CISPR-16-1-2. Most of the old PMM LISN you may own can be upgraded: contact Factory for details
- LISNs ground currents may be hazardous and/or cause ground protection systems to switch off. An isolation transformer of rated current adequate to the equipment under test between mains and LISN input is recommended or mandatory
- Keep connections between Receiver and LISN as short as possible; 9010/30P can be easily placed close by it and operated by battery
- EUT line voltage transients may cause RF noise exceeding the receiver max input level: make sure there are no heavy machinery, contactors, power inverters, inductive or capacitive loads etc. on the same power line or nearby
- An external attenuator at RF input may be useful in case of doubt about the max noise level
- EMI mains filters can be useful to avoid noise pick-up by LISN & cables. Excessive ambient noise may require moving into a shielded room
- Sweep mode + Smart Detector function can dramatically reduce the test time
- Analyzer and Manual modes allow for debugging critical frequencies or spectrum portions
- The Audio Output can be helpful in debugging to discriminate the noise source (other machinery connected to the same line, broadcast, etc.)

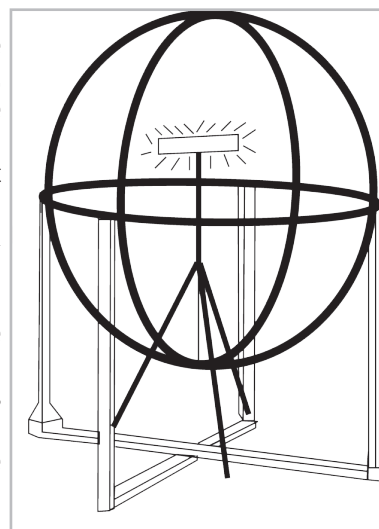
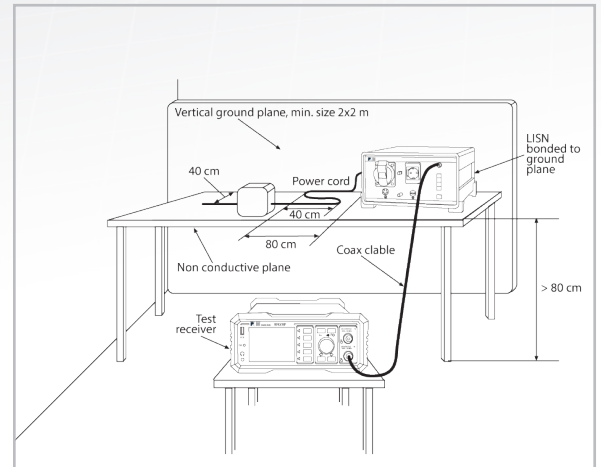

Radiated emission measurements of luminaries by means of the Loop Antenna according to CISPR15/ EN 55015.

Radiated

Radiated Emissions in Pre-Test mode

Reference Standard	Generic Standards	Product Standards
Receiver: CISPR 16-1-1	IEC61000-6-3 IEC61000-6-4 EN...	EN 55014-CISPR 14 EN 55015-CISPR 15 EN 55022-CISPR 22 EN 55025-CISPR 25
Clamp: CISPR 16-1-3	MIL-STD 461	
Test Site: CISPR 16-1-4	Radiated power and emissions 30 MHz - 3 GHz	Radiated power and emissions 30 MHz - 3 GHz

Remark: All above Standards appears as undated for the PMM receivers can be updated to future changes

TIPS:

- Optimal conditions may allow for debugging even in unshielded environment
- Reduce ambient noise by proper antenna orientation
- Care perfect grounding
- Keep cable connection between receiver and antenna as short as possible: 9010/03P, 9010/30P and 9010/60P can be easily placed near the antenna
- To save time start tests in Analyzer mode with selected Limit & max hold on, then use Sweep mode with Smart Detector to focus on critical frequencies only
- Measurements should be taken at min. two heights on four sides, possibly at 3 m distance
- Biconic and Log-periodic antennas are most suitable; see PMM AS 02 Antenna Set
- Consider G-TEM cells for both emission (debugging) and immunity (full compliance)
- For better repeatability reduce variables (e.g. same equipments positioning, cables layout, etc.)
- Demodulated AF output can be helpful to discriminate the noise source (e.g. other machinery, broadcast, etc.) in debugging
- Ambient reflections can increase or decrease results unpredictably
- Recognize other possible RF sources hidden in the environment
- Noise cancellation methods (e.g. via pre-scan and post-processing) may be ineffective if not leading to wrong measurements
- Near field probes may be useful for bench debugging of subassemblies
- In case of excessive ambient noise move into a shielded/anechoic room

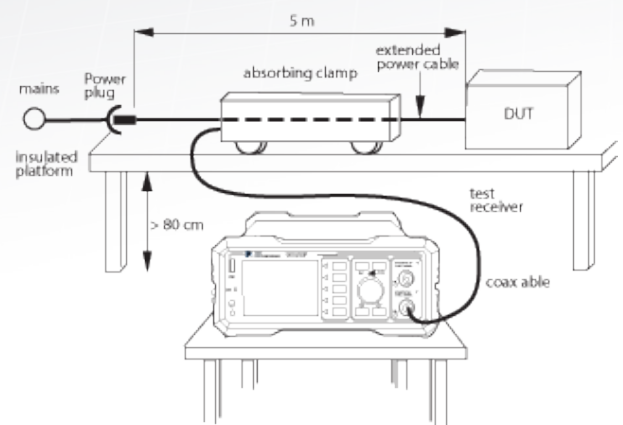

Radiated power measurement set-up with absorbing clamp



Compact Shielded Room

9010/03P
9010/30P
9010/60P

9010/xxP helps saving your time & money, today and tomorrow

- Expandable any time, in any place, by yourself
- Fits in all requirements, from debugging to final, full compliant tests
- Brings innovation, quality, reliability
- More value-added than any other solution

30 - 3000 MHz
Extension Receiver
Module 9030



30 - 6000 MHz
Extension Receiver
Module 9060

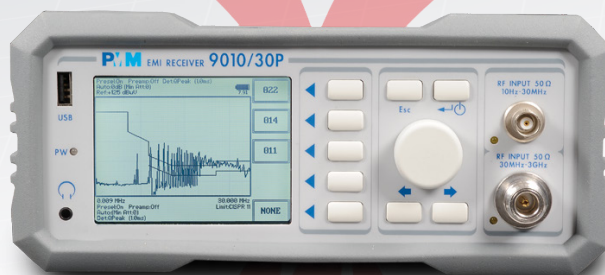

4-Channel Click
Analyzer Module



1-Channel Click
Analyzer Optional
Function (Internal)



6 - 18 GHz
Extension Receiver
Module 9180

PMM's unique Extension Receiver Modules are real EMI Receivers fully compliant to CISPR 16-1-1 that boost the performance of 9010/xxP main unit to the edge of the most sophisticated radiated emission measurements up to 18 GHz.

- Fiber Optic Digital Link for interference-free measurements
- Direct connection to the antenna
- Better overall uncertainty without cable loss
- Automatic Discontinuous Disturbance (Click) Analyzer full compliant to CISPR 14-1, including all latest Exceptions requirements (C-AVG detector)

For further details please consult the brochures 9010/9030/9060 and 9180 downloadable from our web page:
www.narda-sts.it

Emission Suite PC software

The PMM Emission Suite comes with PMM EMI receivers for user-friendly operation as never seen before:

- Full control of all auto and manual Receiver functions
- Real-time display on PC
- One-click operating mode change : Scan/Sweep, Analyzer, Manual
- Import and creation of Limits
- Import and creation of Correction Factors Tables for ancillary equipment (antennas, cables etc.)
- Retrieve, save, recall and compare measurements
- Simultaneous Marker on all Detectors and Zoom
- "n" Highest Peaks Finder and Scan Table generation
- Measured LISN lines scrolling by mouse wheel
- Functions specific to Lighting Equipment (IEC/EN55015, IEC62493)
- 2D - 3D Waterfall and time analysis (option)
- GTEM correlation to OATS (for radiated measurements)
- Warning messages for incorrect settings
- Report generation
- Import-export of complete measurements
- Mast-table control (option)

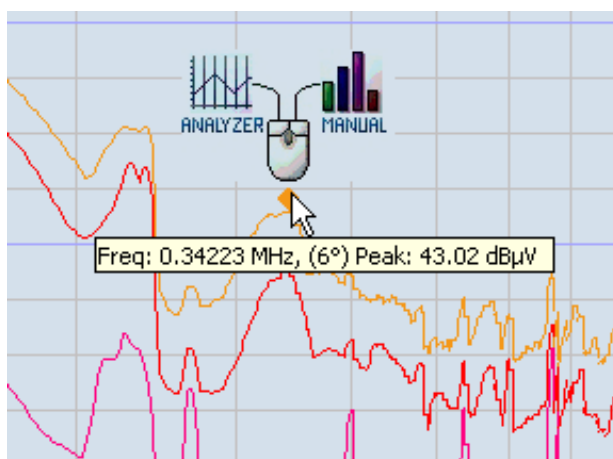
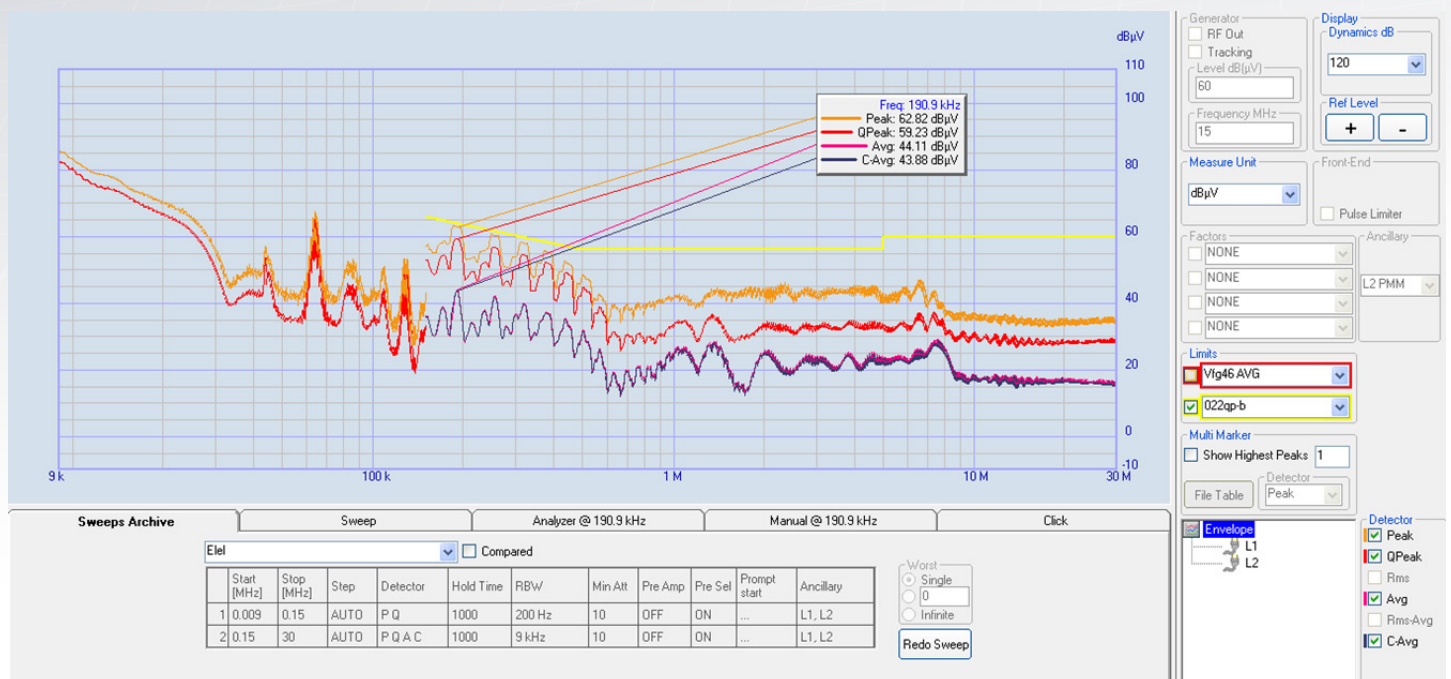

Just one click to move across functions

Powerful, clear scan table

Start [MHz]	Stop [MHz]	Step	Detector	Hold Time	RBW	Min Alt	Pre Amp	Pre Sel	Prompt start	Ancillary
1 76	108	AUTO	P.A	50	120 kHz	0	OFF	ON	VHF	...
2 174	241	AUTO	P.A	50	1 MHz	0	OFF	ON	DAB	...
3 1452	1492	AUTO	P.A	50	1 MHz	0	OFF	ON	DAB-L	...
4 2320	2345	AUTO	P.A	5	1 MHz	0	OFF	ON	SDARS	...
5 47	88	AUTO	P.A	50	1 MHz	0	OFF	ON	TV1	...

Easy setting of limits by bands

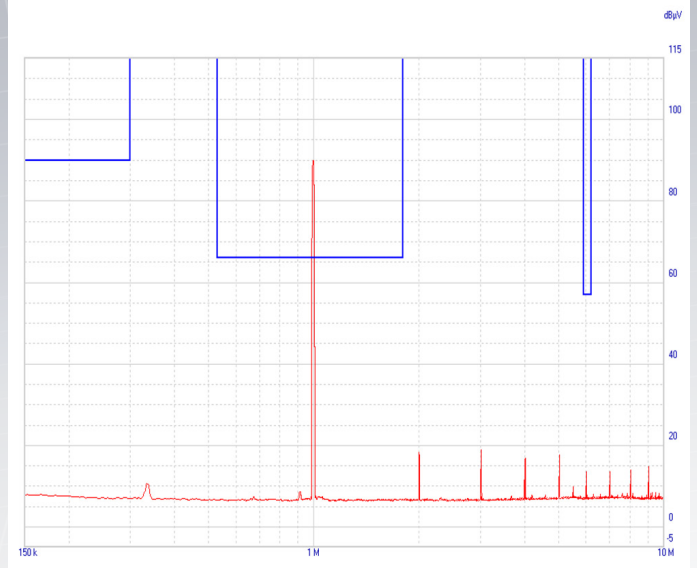

Creation of frequency tables from "N" highest peaks

Frequency Table

	Frequency MHz	Level dBμV
1	0.3136	19.15
2	1.072295	12.86
3	1.83099	12.18
4	2.749195	5.40
5	5.501765	11.36
6	5.804425	6.24
7	6.000745	75.96
8	11.99873	32.62
9	17.99876	37.87
10	29.99882	11.47

Multi Marker
 Highest Peaks
 10
 File Table
 CAvg

Remove row 1

Save Save as text Save as PDF Load from text Load Exit

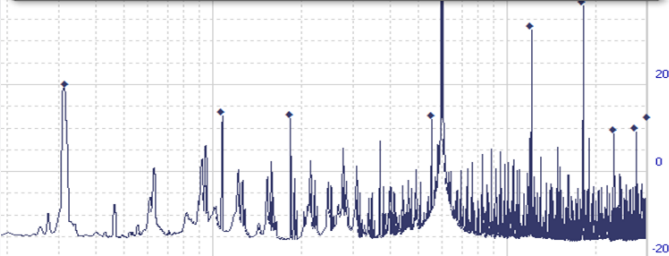

Generation of customizable reports

Company name 

Report issuing date : --/--/----

EUT ----- Receiver -----
 Manufacturer ----- Model -----
 Model ----- S/N -----
 S/N ----- Last Calibration -----
 Notes ----- Ancillary -----
 Operator ----- Model -----
 S/N -----
 Last Calibration -----

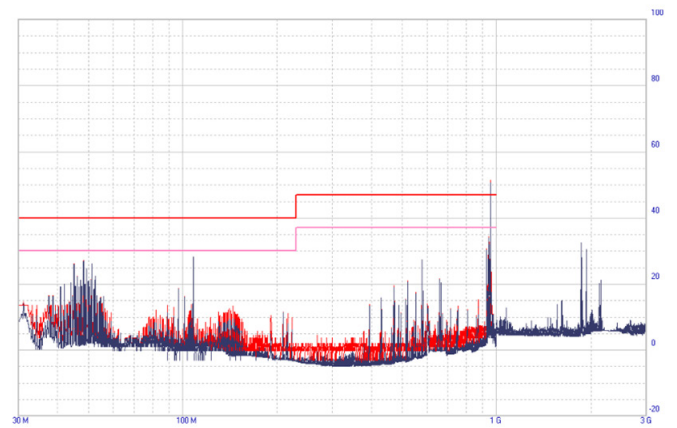

Start [MHz]	Stop [MHz]	Step	Detector	Hold Time	RBW	Min Alt	Pre Amp	Pre Sel	Prompt start	Ancillary
1 30	1000	AUTO (100 kHz)	P.F.R.A.N.C	0.2 ms	120 kHz	10	ON	ON
2 1000	3000	AUTO (250 kHz)	P.A.C.	Lowest	1 MHz	10	ON	ON
3 50	120	AUTO (100 kHz)	P.C.	0.2 ms	120 kHz	10	ON	ON

Ancillary = General
 Limit: <22bq3m (red line)
 <22bq10 (blue line)
 QPeak (red line)
 CAvg (blue line)

Margin: 3 dB

Frequency [MHz]	Peak [dBμV]	Limit c22bq3m [dBμV]	Delta QPeak [dB]	Limit c22bq10 [dBμV]	Delta C-Avg [dB]
1 48.2	28.54	40.00	---	30.00	-2.92
2 48.4	6.49	40.00	---	30.00	-2.92
3 107.7	-1.47	40.00	---	30.00	-1.75
4 955.3	3.80	47.00	4.44	37.00	13.76
5 107.7	-0.13	40.00	---	30.00	-1.97

Displaying of up to 5 arbitrary limits

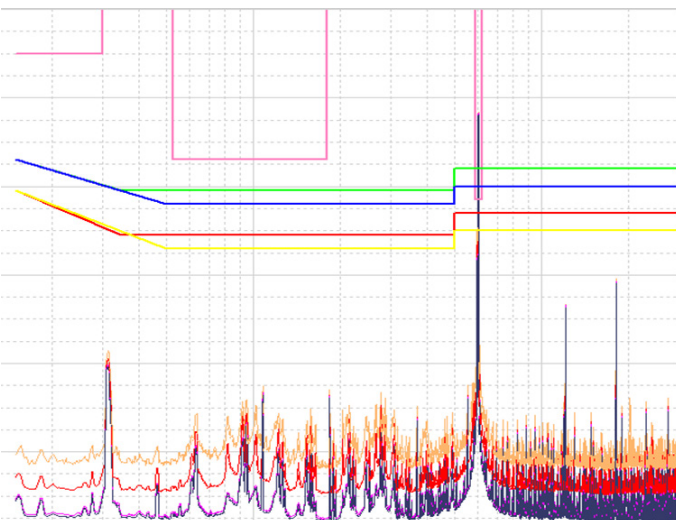

Examples of basic functions

Spectrum Analyzer mode

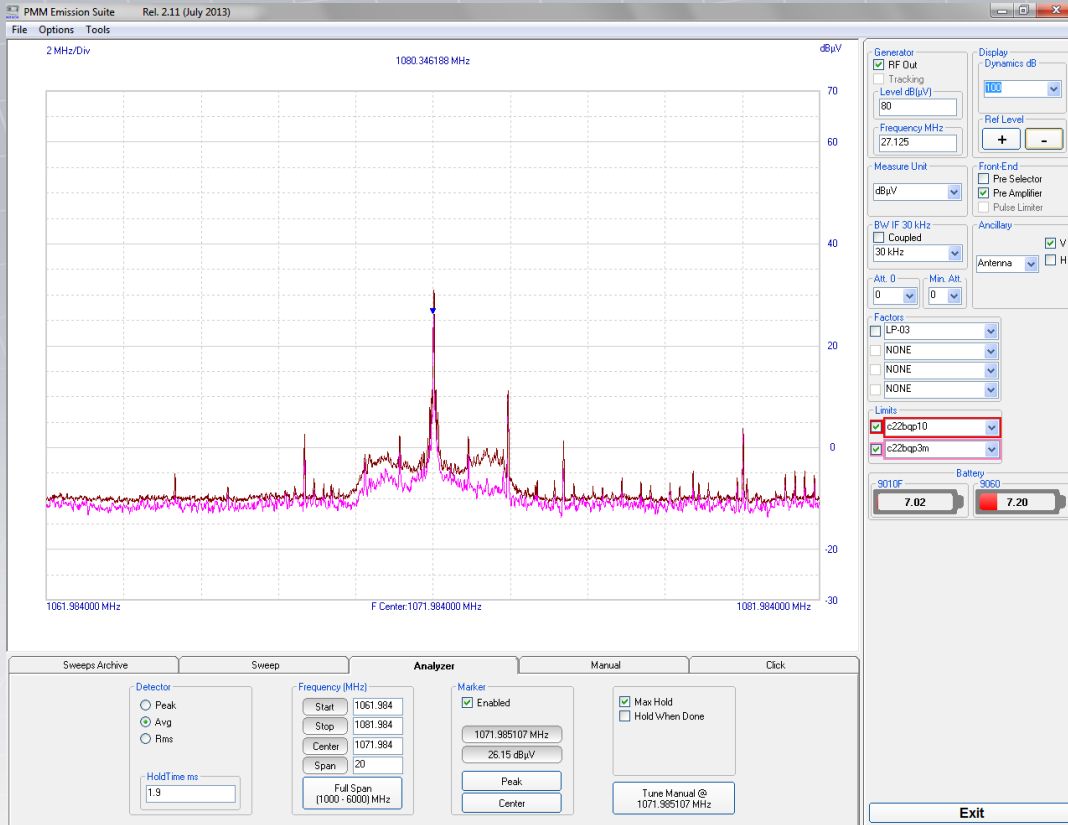

Manual mode

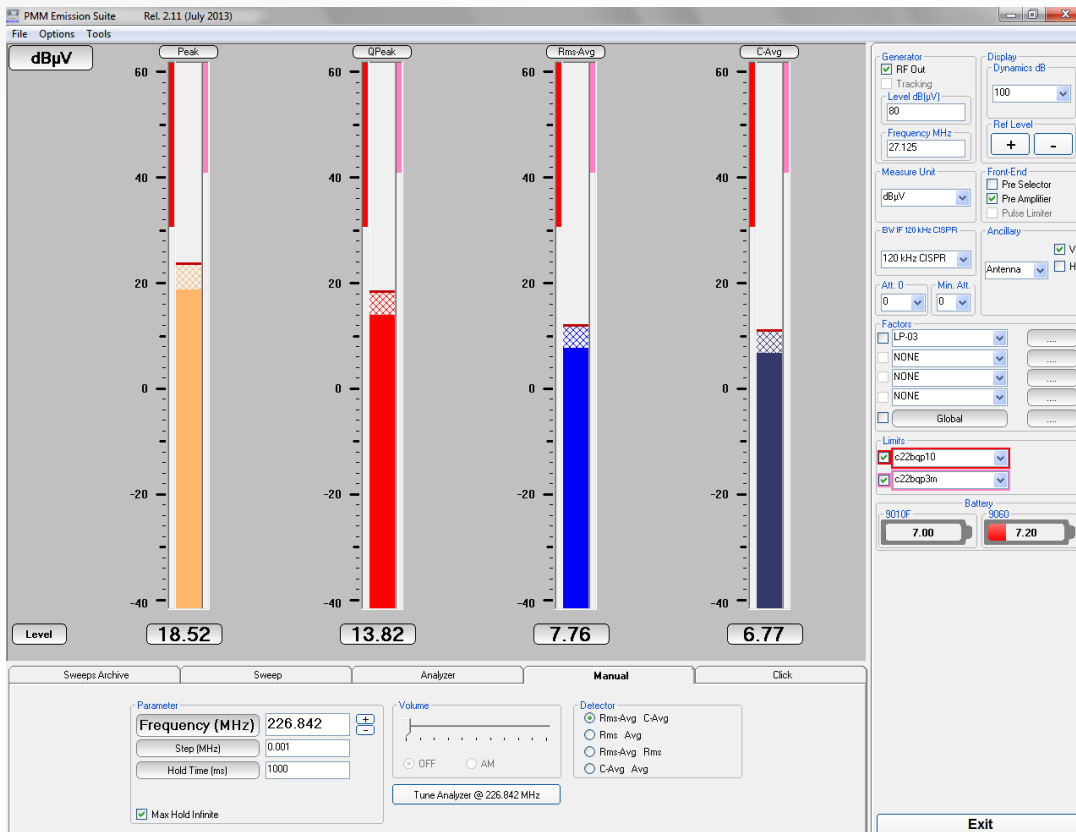

Examples of dedicated functions

IEC 62493

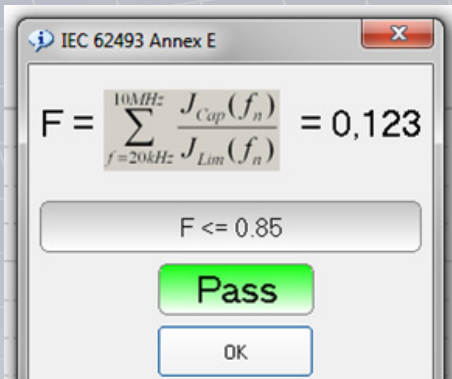

IEC 62493 requires the exposure of humans to the EMF generated by lighting devices to be assessed by measuring the RF field with a dedicated sensor - the Van der Hoofden Test Head - and by calculating an adimensional quantity to be confronted with the reference limit. PMM Emission Suite makes it all automatically and safely, in few clicks!

A standard feature of PMM Emission Suite,

	Start [MHz]	Stop [MHz]	Step	Detector	Hold Time	RBW	Min Alt	Pre Amp	Pre Sel
1	0.02	0.15	220 Hz	P	100	200 Hz	0	OFF	ON
2	0.15	10	10 kHz	P	20	9 kHz	0	OFF	ON

G-TEM correlation

According to the EMC Standard EN 61000-4-20, measurements obtained from TEM / G-TEM cells by an EUT rotated along its x-y-z axis can be correlated to those obtained in an OATS (Open Area Test Site) by specific algorithms. The G-TEM correlation function correlates in few clicks the x-y-z measurements into a final measurement spectrum that can be compared with the limits. A standard feature of PMM Emission Suite,

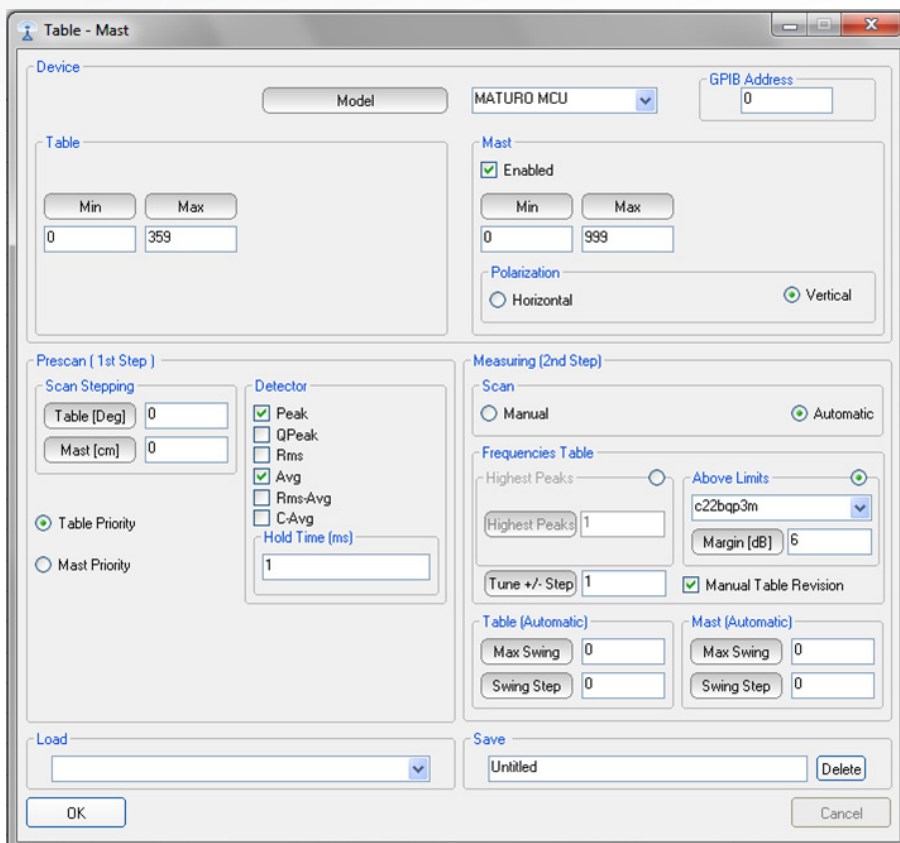
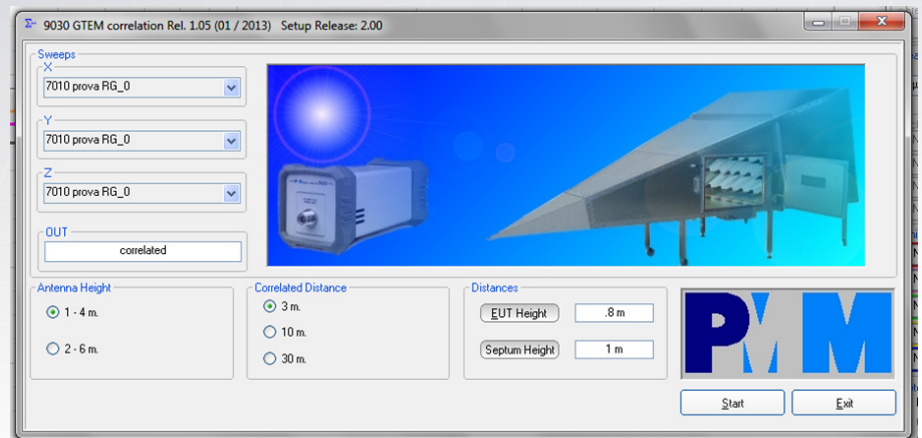

Turntable and antenna mast control (option)

This function provides an intuitive but complete setting of two-step - pre-scan and scan - automatic measurements of radiated emissions by controlling the antenna mast and the turntable via GPIB (external controller required - check for the compatibility).

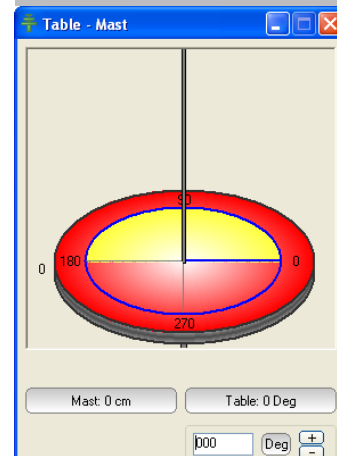

When debugging the antenna and turntable positioning can be set manually and the receiver operated in Manual and Analyzer modes.

SIMULTANEOUS TIME & FREQUENCY DOMAIN ANALYSIS

An optional function of PMM Emission Suite for collecting subsequent spectra displayed in 3-D: frequency, amplitude and time, to see at a glance the variations of the spectral components during time.

This allows for an immediate correlation of the disturbance with the EUT operating cycles, e.g. during its run up - run down phases, and generally for recognizing intermittent disturbances.

The time history of the spectra can be displayed in two ways:

Waterfall diagram, particularly useful when the spectral contents are relatively limited, e.g. in presence of narrowband disturbances

Spectrogram, showing the peaks amplitude with different colors, more useful for complex, broadband disturbances

The time history can cover several hours; the cursor gives full information of each single peak. Display commands include size, scrolling, orientation, dynamic, color management.

Purchase of activation code required.

Waterfall diagram

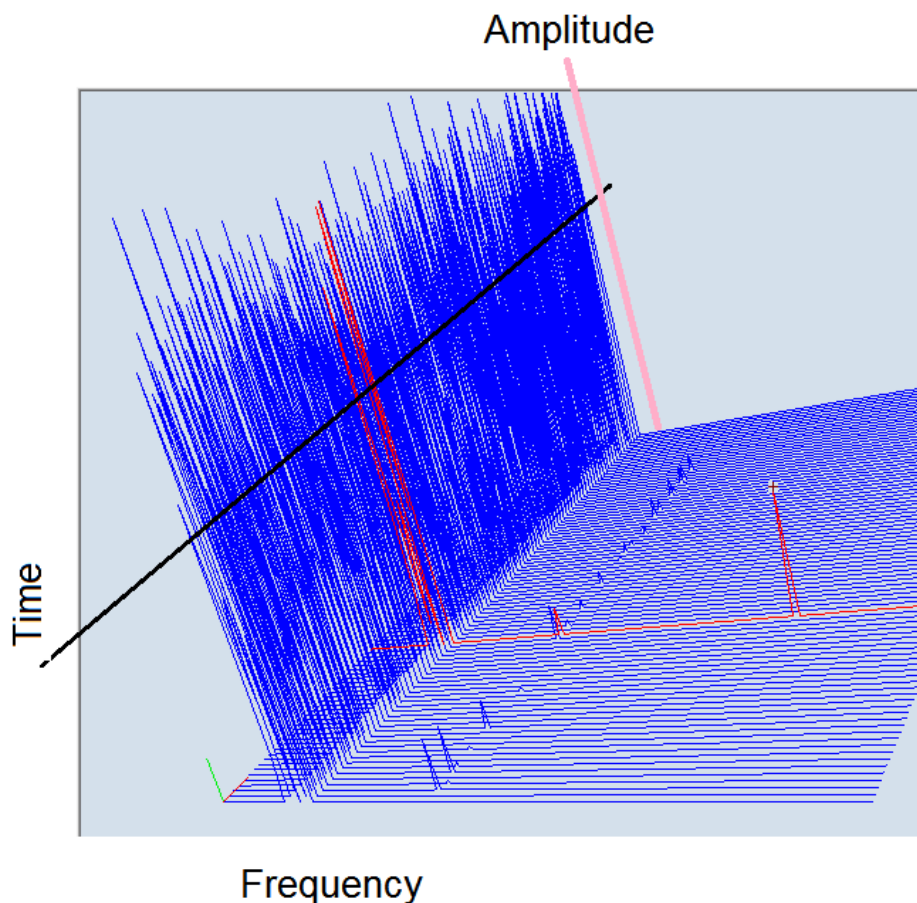

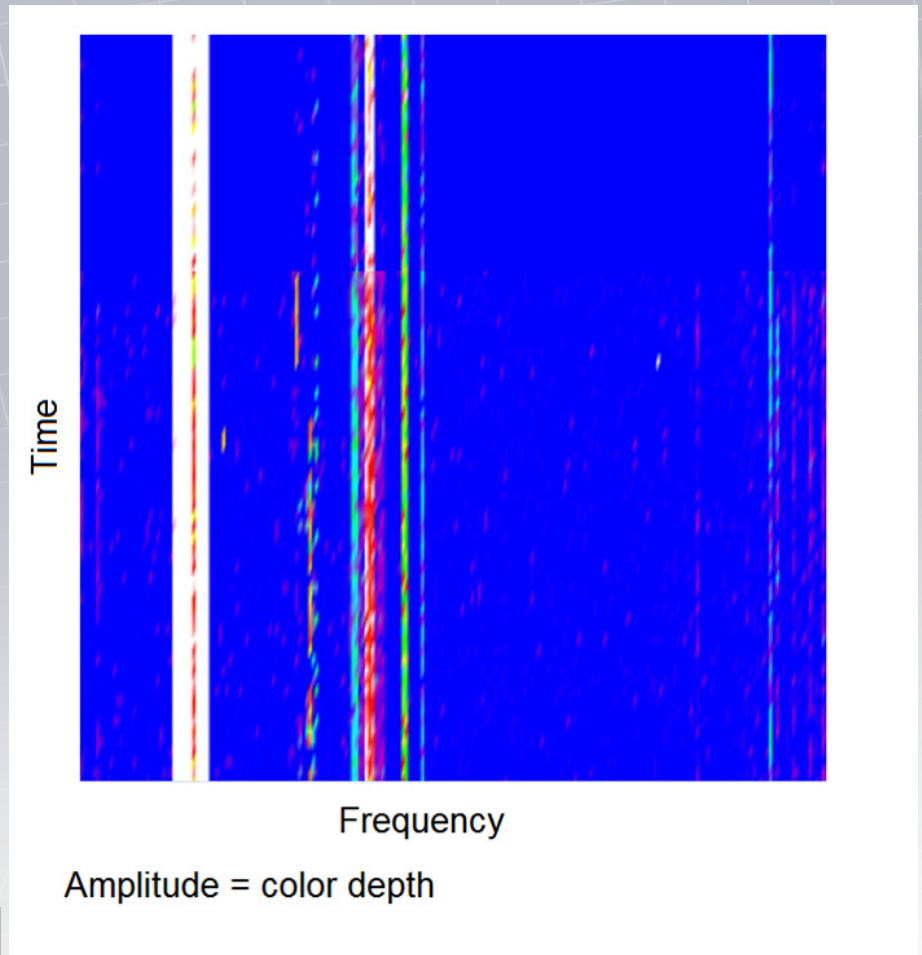

Spectrogram diagram

Time history of a single frequency

When a specific frequency is selected by the marker (left) its changes of amplitude during time can be displayed and measured, for an immediate correlation with the EUT operation or cycle that may generate the disturbance.

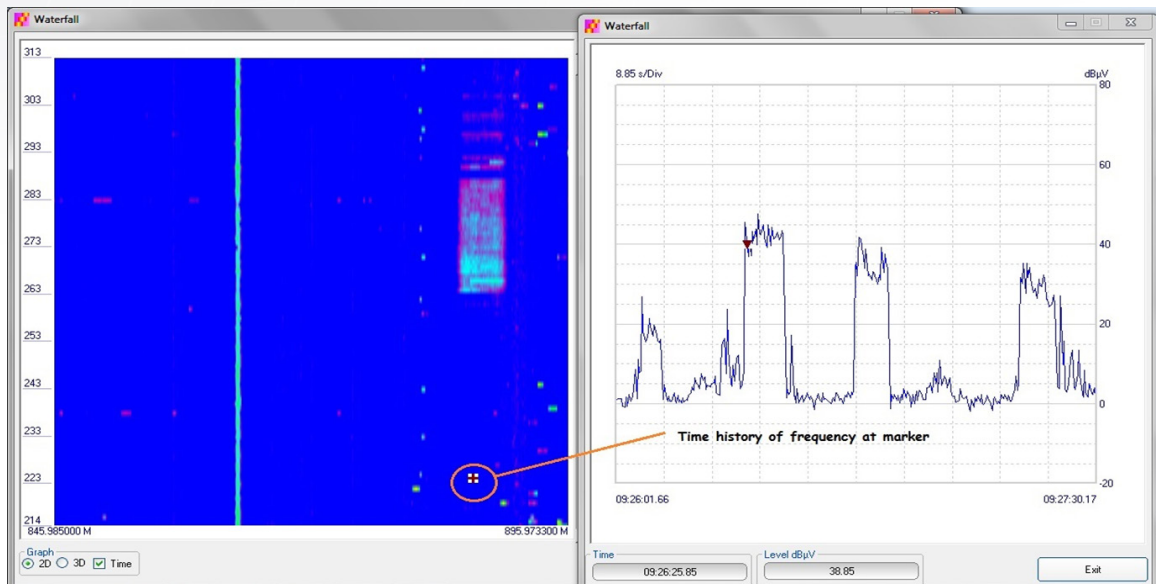

User-upgradeable Firmware

A simple utility included in the PMM Emission Suite CD allows the user to upgrade the firmware of his own PMM receiver whenever required by future standards, measuring features and test solutions. A dedicated operating system allows the PMM 9010 to be ready to use just few seconds after power on.

An exclusive "parking memory" makes upgrading the PMM Receivers Firmware totally failsafe against unexpected interruptions that may occur during downloading.

Ancillary Equipment & Accessories

Conducted Measurements

AMN-Artificial Mains Networks

Also known as LISN (Line Impedance Stabilization) these equipments are used for RF measurements in the frequency range from 9 kHz to 30 MHz on AC single and three-phase lines, from DC to 60 Hz. The V-network design is fully compliant with latest CISPR publ. 16 and FCC part 15 regulation.

General features:

- automatic line switching control from PMM EMI receivers
- artificial hand circuit
- 150 kHz high-pass filter control

Most common models:

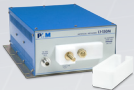

L1-150M:
Single line LISN,
150A



L1-500:
Single line LISN,
500A



L2-16B:
Two lines, Single phase,
16A



L3-32:
Four lines, 3-phase + neutral,
32A



L3-64:
Four lines, 3-phase + neutral,
63A



L3-64/690V:
Four lines, 3-phase + neutral,
63A



L3-100:
Four lines, 3-phase + neutral,
100A



L3-500:
Four lines, 3-phase + neutral,
500A

**Models UL/CS and
MIL-STD available**

Radiated Measurements

Measuring Antennas

Measuring antennas of excellent electrical performances and mechanical stability are essential in radiated measurements for repeatable and reliable results.

General features:

- Robust construction in passivated Aluminium
- Weather-resistant paint
- Lightweight
- Hi-quality RF connectors
- Easy to assembly and store

Most common models:



BC-01:
Biconical Antenna
30-200 MHz



LP-02:
LogPeriodic Antenna
200-3000 MHz



LP-02:
LogPeriodic Antenna
200-3000 MHz



PMM AS-02 and AS-03:
convenient Antenna Sets complete
of all antennas to cover 30 MHz to
3 and 6 GHz respectively.
Supplied with tripod, RF cable and
carrying bag.



DR-01:
Double-ridged Horn Antenna
6 - 18 GHz



Model VDH-01:
Van der Hoofden Test Head
Compliant to IEC 62493

Specifications

	10 Hz – 30 MHz Input (Common for every model PMM 9010/xxP)
	Scanning receiver Manual tuning receiver Analyzer
Frequency range Resolution Frequency accuracy	10 Hz to 30 MHz 0,1 Hz <1 ppm
RF input VSWR Attenuator Pulse limiter Preamplifier	50 Ω, BNC female <1,2 (10 dB RF att.) 0 to 35 dB, 5 dB step Built-in, selectable 20 dB
Max input level (without equipment damage) Sinewave AC voltage Pulse spectral density	137 dBμV – 1 W 97 dBμV/MHz
Preselector	1 x LP; 6 x BP filters
IF RBW Normal CISPR 16-1-1 MIL-STD-461 (option)	(3 dB BW) 3, 10, 30, 100, 300 kHz 200 Hz; 9 kHz 10, 100 Hz; 1, 10 kHz
Noise level	(Preamplifier ON) 9 – 150 kHz RBW 200 Hz, QP <-8 dBμV RBW 200 Hz, Avg <-15 dBμV 0,15 – 30 MHz RBW 9 kHz, QP <-4 dBμV RBW 9 kHz, Avg <-10 dBμV
Spurious response Mode: Sweep RBW: Auto Preamp.: ON RF Att.: 0 dB	<0 dBμV; < 10 dBμV over 150 kHz
Detectors (Simultaneous on PMM Emission Suite) Hold time	Peak, Quasi-Peak, C-Average, Average, RMS-Average (*), RMS, APD, Smart Detector function 1 ms to 30 s
Stand-alone display & measure functions	Marker; marker peak; marker to center; highest peaks; Move peak to Analyzer & Manual modes; Store & Load: - up to 11 traces (sweep mode) - two panels - 4 conversion factors Built-in limits: CISPR 11, 14, 22 (can be changed by the PMM Emission Suite) Battery charge and voltage, Display style, contrast, backlight, Click functions (option required)
Measuring units Stand-alone PMM Emission Suite	dBm, dBμV dBμA, dBpW, dBμV/m, dBμA/m
Displayed dynamic	80, 100, 120 dB selectable
Measurement accuracy (S/N > 20 dB)	10 Hz to 9 kHz ±1,0 dB 9 kHz to 30 MHz ±1,0 dB
Autocalibration (1)	Internal reference source
Demodulation	AM with variable volume
I/O Interface	USB; RS-232, High Speed Optical, User Port (drives PMM LISNs/accessories), Bluetooth (optional)
Operating temperature	0° to 40°C
Power supply	AC universal adapter/charger External 10 - 15 Vdc, 2.5A Li-Ion rechargeable plug-in battery (Option)
Battery operation time	3 h (2)
Dimensions	235x105x335 mm
Weight (including battery option)	4,95 kg

(1) RF front-end only. All RBW filters and detectors are digital and do not require any re-calibration, any time.

(2) Minimum value; may be higher in relation with the selected operating mode.

(*) RMS-average detector manufactured under license of Rohde & Schwarz GmbH & Co. KG.



Specifications

Input 30 MHz - 300 MHz (PMM 9010/03P)	Input 30 MHz - 3 GHz (PMM 9010/30P)	Input 30 MHz - 6 GHz (PMM 9010/60P)
Scanning receiver Manual tuning receiver Analyzer		
30 MHz to 300 MHz 100 Hz <2 ppm	30 MHz to 3 GHz 100 Hz <2 ppm	30 MHz to 6 GHz 100 Hz <2 ppm
50 Ω, N-F <1,2 0 to 50 dB, 2 dB step n.a. n.a.	50 Ω, N-F <1,2; <2 over 1 GHz 0 to 50 dB, 2 dB step n.a. n.a.	50 Ω, N-F <1,2; <2 over 1 GHz; <3 over 3 GHz 0 to 55 dB, 5 dB step n.a. n.a.
137 dBμV - 1 W 97 dBμV/MHz	137 dBμV - 1 W 97 dBμV/MHz	137 dBμV - 1 W 97 dBμV/MHz
n.a.	n.a.	n.a.
(6 dB BW) 3, 10, 30, 100, 300 kHz, 1 MHz 9 kHz, 120 kHz, 1 MHz 100 kHz, 1 MHz	(6 dB BW) 3, 10, 30, 100, 300 kHz, 1 MHz 9 kHz, 120 kHz, 1 MHz 100 kHz, 1 MHz	(6 dB BW) 3, 10, 30, 100, 300 kHz, 1 MHz 120 kHz 100 kHz, 1 MHz
30 to 300 MHz < 8 dBμV (QP) (120 kHz RBW) < 4 dBμV (AV)	30 MHz - 3 GHz RBW 120 kHz, QP < 8 dBμV RBW 120 kHz, Avg < 4 dBμV	30 to 300 MHz < 10 dBuV (QP) (120 kHz BW) < 7 dBuV (AV) 300 to 3000 MHz < 13 dBuV (QP) (120 kHz BW) < 7 dBuV (AV) 3000 to 6000 MHz < 15 dBuV (QP) (120 kHz BW) < 10 dBuV (AV)
< 15 dBμV	< 15 dBμV	< 10 dBμV; < 15 dBμV over 2 GHz
Peak, Quasi-Peak, C-Average, Average, RMS-Average (*), RMS, APD, Smart Detector function		
1 ms to 30 s		
Marker; marker peak; marker to center; highest peaks; Move peak to Analyzer & Manual modes; Store & Load: - up to 11 traces (sweep mode) - two panels - 4 conversion factors Built-in limits: CISPR 11, 14, 22 (can be changed by the PMM Emission Suite) Battery charge and voltage, Display style, contrast, backlight, Click functions (option required)		
dBm, dBμV dBμA, dBpW, dBμV/m, dBμA/m		
80, 100, 120 dB selectable		
±1,0 dB	30 MHz to 1 GHz ±1,0 dB 1 to 3 GHz ±1,5 dB	30 MHz to 1 GHz ± 1,0 dB 1 GHz to 3 GHz ± 1,5 dB 3 GHz to 6 GHz ± 2,0 dB
n.a.		
AM with variable volume		
USB; RS-232, High Speed Optical, User Port (drives PMM LISNs/accessories), Bluetooth (optional)		
0° to 40°C	0° to 40°C	0° to 40°C
AC universal adapter/charger External 10 - 15 Vdc, 2.5A Li-Ion rechargeable plug-in battery (Option)	AC universal adapter/charger External 10 - 15 Vdc, 2.5A Li-Ion rechargeable plug-in battery (Option)	AC universal adapter/charger External 10 - 15 Vdc, 2.5A Li-Ion rechargeable plug-in battery (Option)
3 h (2)	3 h (2)	3 h (2)
235x105x335 mm	235x105x335 mm	235x105x335 mm
4,1 kg	4,1 kg	4,1 kg

(1) RF front-end only. All RBW filters and detectors are digital and do not require any re-calibration, any time.

(2) Minimum value; may be higher in relation with the selected operating mode.

(*) RMS-average detector manufactured under license of Rohde & Schwarz GmbH & Co. KG.

Ordering Information

9010/03P	EMI receiver 10 Hz to 300 MHz, two RF inputs: CISPR 16-1-1 full compliance 9 kHz to 30 MHz CISPR 16-1-1 compliance to PRF = 10 Hz, 30 to 300 MHz
9010/03P/UP/30P	Factory upgrade of mod. 9010/03P to 9010/30P (3 GHz). Includes new calibration certificate.
9010/03P/UP/60P	Factory upgrade of mod. 9010/03P to 9010/60P (6 GHz). Includes new calibration certificate.
9010/30P	EMI receiver 10 Hz to 3 GHz, two RF inputs: CISPR 16-1-1 full compliance 9 kHz to 30 MHz CISPR 16-1-1 pre-compliance 30 MHz to 3 GHz
9010/30P/UP/60P	Factory upgrade of mod. 9010/30P to 9010/60P (6 GHz). Includes new calibration certificate.
9010/60P	EMI receiver 10 Hz to 6 GHz, two RF inputs: CISPR 16-1-1 full compliance 9 kHz to 30 MHz CISPR 16-1-1 pre-compliance 30 MHz to 6 GHz
9030	Extension unit 30 MHz to 3 GHz (UKAS accredited calibration on option)
9060	Extension unit 30 MHz to 6 GHz (UKAS accredited calibration on option)
9180	Extension unit 6 GHz -to18 GHz (UKAS accredited calibration on option)
9010/UKAS	CISPR-16-1-1 accredited calibration certificate for 9010
9010/UKAS-Click	UKAS accredited calibration certificate for bands A, B (9 kHz to 30 MHz) + 9010/Click according to CISPR-16-1-1 & CISPR-14-1

Optional Accessories and Functions

9010/MIL	MIL-STD-461F RBW Filters
9010/RAV	CISPR RMS-AVG detector
9010/CLICK	1-channel Click Analyzer function, CISPR 14-1: 2005 full-compliance, including: - Switching Operation Box, control cables, 2x20 dB attenuator NOTE: field-installable function (advice S/N for upgrading confirmation)
9010/CLICK4E	External box to connect to a receiver 9010 equipped with 9010/click option. Allows four-channel simultaneous click measurements according to CISPR-14-1-1. AC power only.
9010/BTA	RS-232 to Bluetooth adapter
9010/GPIB-232CV-A	RS-232 to GPIB (IEEE-488) external adapter
BP01	Spare Li-Ion Battery Pack for 9010/xxP, 9030, 9060 or 9180
9010/AC	AC adapter/charger for BP01, 9010/xxp, 9030, 9060 or 9180
9010/FO-xx	20, 50 or 100 m fiber optic cable for 9030, 9060 or 9180
9010/CC	Rigid carrying case for 9010/xxP
9010/RMA	19" Rack mount adapter for 9010 Series and 3010, 3030
PES/WF	Waterfall and Spectrogram function of PES-PMM Emission Suite
PES/TM	Table and Mast control function of PES-PMM Emission Suite (Check controller availability)

Ancillary equipments

LISN controlled by the PMM 9010F receiver to automatically the lines to measure	<ul style="list-style-type: none"> • L1-150M: single-path, 50 Ohm AMN, 150 A • L1-150M1: single-path, 50 Ohm AMN, 150 A • L1-500: single phase AMN, 500 A • L2-16B: single phase AMN, 16 A • L3-32: 4 lines, 3-phase AMN, 32 A • L3-64: 4 lines, 3-phase AMN, 63 A • L3-64/690V: 4 lines, 3-phase AMN, 63 A • L3-100: 4 lines, 3-phase AMN, 100 A • L3-500: 4 lines, 3-phase AMN, 500 A • L2-D: Delta LISN for telecom, 2 A, 150 Ω
CISPR 16-1-2	<ul style="list-style-type: none"> • SHC-1/1000: Voltage probe, 1000 Vac, 35 dB • SHC-2/1000: Voltage probe, 1000 Vac, 30 dB
Antennas	<ul style="list-style-type: none"> • RA-01: Rod Antenna 9 kHz to 30 MHz • RA01-HV: Rod Antenna 150 kHz to 30 MHz • RA01-MIL: Rod Antenna 9 kHz to 30 MHz • BC-01: Biconical Antenna 30 to 200 MHz • DR-01: Double-ridged Antenna 6 to 18 GHz • LP-02: Log Periodic Antenna 200 MHz to 3 GHz • LP-03: Log Periodic Antenna 800 MHz to 6 GHz • VDH-01: Van der Hoofden test-head 20 kHz to 10 MHz
EN55015 (CISPR 15) components	<ul style="list-style-type: none"> • F-330M-16: CDN 150 kHz - 30 MHz; 250VAC - 16A; 50/60 Hz for power circuitry testing with phase, neutral and PE • RF-300: 3-axis Loop Antenna System For CISPR 15 EN55015 • TRF-1: Balance/unbalance transformer • RF-300C: Calibration kit for RF-300 • SBRF4: X-Y-Z Switching Box for automatic operation of RF-300 • DL-xx: Dummy lamps according to the standard

9010/xxP can also be used with other accessories available on market: LISN, any type; Antennas and Loops; Near Field Probes; TEM/GTEM Cells